

# LANDA®

illuminotecnica

luce italiana  
**2016|17**

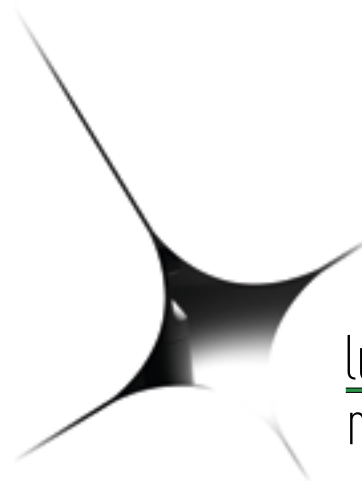



luce italiana  
made in Italy

**LANDA®**

illuminotecnica



**l'azienda**  
**the company**  
**la société**  
**la empresa**  
**die Firma**

La ditta Landa illuminotecnica ha sede a Lumezzane, Brescia, area dell'Italia del nord conosciuta per il suo spirito imprenditoriale che ha saputo distinguersi in diversi settori. Presente sul mercato dal 1987, si è affermata con la sua ampia gamma di lampade da esterno non solo sul mercato europeo ma a livello mondiale. L'intera produzione avviene all'interno della ditta, consentendo un costante monitoraggio di tutte le fasi produttive fino al momento della spedizione. Vanta inoltre un'equipe di progettazione che non solo riesce a soddisfare le esigenze presentate dalla clientela ma è anche attenta ad anticipare i nuovi bisogni ed i nuovi trend del gusto. Tutto ciò ha permesso una continua crescita in un mercato sempre più competitivo.



[www.landa.it](http://www.landa.it)

Le siège de la société Landa Illuminotecnica est situé à Lumezzane, près de Brescia, une zone de l'Italie du nord réputée pour son esprit d'entreprise et qui a su se distinguer dans différents secteurs d'activité. Depuis 1987 Landa s'est imposée avec une vaste gamme de luminaires pour extérieur, non seulement sur le marché européen mais également au niveau mondial. Toute la production est réalisée en interne, ce qui permet un contrôle constant de toutes les phases productives jusqu'au moment de l'expédition. Landa dispose d'une équipe de Recherche & Développement capable non seulement de satisfaire les exigences actuelles des clients, mais aussi d'anticiper les nouveaux besoins et l'évolution des goûts et des attentes. Tout ceci a permis une progression constante dans un marché toujours plus concurrentiel.

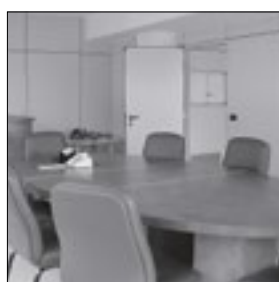

# LANDA®

🇬🇧 Landa Illuminotecnica is situated in Lumezzane, Brescia, an area of northern Italy well known for the entrepreneurial spirit of its people, which has made this area very successful in many fields.

Landa was founded in 1987 and has made itself known on the outdoor lighting market, both in Europe and Worldwide, with a comprehensive range of products. All production stages are carried out within the factory bound, so that every step, from production to delivery, can be carefully monitored. Landa's team seeks to fulfil customers' needs as well as trying to anticipate future market needs and trends.

This continuous effort has enabled us to achieve constant growth in an increasingly competitive market.



🇪🇸 La empresa Landa Illuminotecnica sita en Lumezzane, Brescia, Italia, conocida por su espíritu emprendedor y supo diferenciarse en varios sectores. Está presente en el mercado desde 1987, se ha consolidado con un extenso surtido de lámparas para exteriores, estamos presentes no solamente en Europa más bien en el mercado a nivel mundial. La totalidad de nuestras piezas están hechas directamente en nuestras instalaciones así controlamos cada paso de la producción desde el comienzo hasta el despacho. Tenemos un grupo de técnicos para proyectar nuestra producción que, no solamente llega a satisfacer las exigencias presentadas por nuestros clientes, también están atentos a anticipar los gustos, las tendencias y las nuevas necesidades del mercado. Todo esto nos ha permitido crecer en un mercado cada vez más competidor.

🇩🇪 Landa Illuminotecnica hat seinen Sitz in Lumezzane Brescia im Norden Italiens, bekannt für seinen Unternehmungsgeist, was die Gegend in so vielen Bereichen erfolgreich macht. Die Firma Landa wurde 1987 gegründet und hat seitdem eine große Auswahl von Außenleuchten entwickelt, die jetzt auf der ganzen Welt bekannt sind. Jede Stufe der Produktion findet innerhalb der Firma statt, so kann die Ware von der Produktion bis zur Lieferung bestens kontrolliert werden. Unsere Firma beschäftigt ein Planungsteam, das den Ansprüchen der Kunden nachkommt und neue Bedürfnisse und Trends aufgreift. Das hat uns die Möglichkeit gegeben, ein stetiges Wachstum in einem immer wettbewerbsintensiveren Umfeld zu erreichen.



la produzione  
the production  
la production  
la producción  
die produktion



02 | Projectors

12 | Recessed  
wall recessed - ingrounds

52 | Contemporary  
wall lights - sensor - suspensions - bollards and poles

160 | Traditional  
wall lights - sensor - suspensions - bollards and poles

projectors



**lyras 45**  
p.2-3



**lyras 65 (24V)**  
p.4-5



**lyras 65 (AC/240V)**  
p.6-7



**lyras 130**  
p.8-9



**flute**  
p.10-11



**mira 45 LT**  
p.12



**wall mira 45**  
p.14



**wall mira 45**  
p.14



**wall mira 45**  
p.15



**wall mira 45**  
p.15

wall recessed



**wall mira 65 (24V)**  
p.16-17



**wall mira 65 (24V)**  
p.16-17



**wall mira 65 (AC/240V)**  
p.18-19



**wall mira 65 (AC/240V)**  
p.18-19



**round brick light**  
p.20-21



**brick light**  
p.22-25



**brick light**  
p.26-27

# INDEX

LANDA®  
illuminotecnica

INDEX



**mira 45**  
p.28-29



**mira 45**  
p.30



**mira 45**  
p.30



**mira 45**  
p.31



**mira 65 (24V)**  
p.32



**mira 65 (24V)**  
p.33



**mira 65 (AC/240V)**  
p.34



**mira 65 (AC/240V)**  
p.35



**mira 150**  
p.36-37



**mira 220**  
p.38-39



**mira 220**  
p.40-41



**mira 200**  
p.42-43



**mira 200**  
p.44-45



**mira 200**  
p.46-47



**mira 220**  
p.48-49



**mira 220**  
p.48-49







ingrounds

wall lights traditional

						
<b>parigi</b> p.162-163	<b>parigi</b> p.162÷167	<b>lampara</b> p.168-169	<b>saturno</b> p.170-171	<b>sirio</b> p.172-173	<b>toscana</b> p.174-175	
						
<b>toscana</b> p.176-177	<b>venezia mini</b> p.178	<b>venezia</b> p.178÷181	<b>amalfi</b> p.182÷187	<b>firenze</b> p.188-189	<b>monaco</b> p.190-191	<b>romantica</b> p.192÷195
						
<b>augusta</b> p.196÷199	<b>nizza</b> p.200-201	<b>pisa</b> p.202	<b>oslo</b> p.203	<b>rio</b> p.204-205	<b>cipro</b> p.206	<b>maiorca</b> p.207

INDEX  
A6

suspensions

						
<b>lyras 130</b> p.8-9	<b>morphis</b> p.80 / 84	<b>morphis</b> p.76-77	<b>morphis</b> p.80 / 84	<b>liberty</b> p.88-89	<b>oko</b> p.100-101	<b>cervinia</b> p.150-151



						
<b>morphis</b> p.86-87	<b>luna</b> p.126-127	<b>cervinia</b> p.148-149	<b>cervinia</b> p.150-151	<b>acqua</b> p.152-153	<b>rio</b> p.204-205	<b>maiorca</b> p.207



**tubo**  
p.50-53

**kubs**  
p.54-55

**lako**  
p.56-57

**beam**  
p.58-59

**dolby 2**  
p.60-61

**lyras 80**  
p.62-63



**lyras 130**  
p.64-65

**sunny**  
p.70-71

**sunny**  
p.72-73

**morphis**  
p.86-87

**morphis**  
p.74-75

**morphis**  
p.76-77

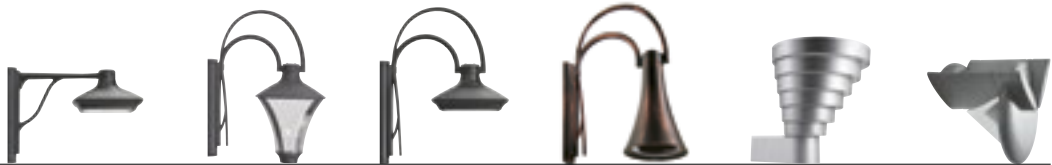

**morphis**  
p.80-81

**morphis**  
p.82-83

**morphis**  
p.84-85

**liberty**  
p.88-89

**ivanhoe**  
p.90-91

**ibis 2 LED**  
p.92-93



**ibis 2**  
p.94-95

**kami**  
p.96-97

**kami**  
p.98-99

**oko**  
p.100-101

**oko**  
p.100-101

**titano**  
p.106-109



**titano**  
p.110-111

**neway**  
p.112-113

**polos**  
p.118-119

**polos**  
p.118-119

**polos**  
p.120-123

**polos**  
p.120-121



**luna**  
p.124-127

**titano INOX**  
p.128-129

**urano**  
p.130-131

**orion**  
p.132-133

**orion**  
p.134-135

**orion INOX**  
p.136-137



**orion INOX**  
p.138-139

**urano**  
p.140-141

**urano**  
p.140-141

**colonna 52**  
p.142-143

**colonna 76**  
p.144-145

**colonna 76**  
p.144-145



**lampara INOX**  
p.146-147

**cervinia**  
p.148-149

**cervinia**  
p.150-151

**cervinia**  
p.150-151

**acqua**  
p.152

**acqua**  
p.153

wall lights contemporary



						
<b>kubs</b> p.66-67	<b>lako</b> p.68-69	<b>sunny</b> p.70-71	<b>sunny</b> p.72-73	<b>morphis</b> p.74-75	<b>morphis</b> p.76-77	<b>morphis</b> p.78-79
						
<b>morphis</b> p.80-81	<b>morphis</b> p.82-83	<b>morphis</b> p.84-85	<b>liberty</b> p.88-89	<b>ivanhoe</b> p.90-91	<b>ibis 2</b> p.92-93	<b>ibis 2</b> p.94-95
						
<b>oko</b> p.102-103	<b>oko</b> p.104-105	<b>titano</b> p.106-109	<b>titano</b> p.110-111	<b>neway</b> p.114-115	<b>neway</b> p.116-117	<b>polos</b> p.118-119
						
<b>polos</b> p.118-119	<b>polos</b> p.120-121	<b>polos</b> p.120-121	<b>polos</b> p.122-123	<b>polos</b> p.122-123	<b>luna</b> p.124-127	<b>titano INOX</b> p.128-129
						
<b>titano INOX</b> p.130-131	<b>orion</b> p.132-133	<b>orion</b> p.134-135	<b>orion INOX</b> p.136-137	<b>orion INOX</b> p.138-139	<b>urano</b> p.140-141	<b>colonna 52</b> p.142-143
						
<b>colonna 52</b> p.142-143	<b>colonna 76</b> p.144-145	<b>lampara INOX</b> p.146-147	<b>posts beta Country</b> p.154-155	<b>posts beta</b> p.156-157	<b>posts liberty</b> p.158	<b>accessories posts</b> p.159
						
<b>parigi</b> p.162-167	<b>lampara</b> p.168-169	<b>saturno</b> p.170-171	<b>sirio</b> p.172-173	<b>toscana</b> p.174-177	<b>venezia</b> p.178-181	<b>amalfi</b> p.182-187
						
<b>firenze</b> p.188-189	<b>monaco</b> p.190-191	<b>romantica</b> p.192-195	<b>augusta</b> p.196-199	<b>nizza</b> p.200-201	<b>pisa</b> p.202	<b>oslo</b> p.203
						
<b>PALI</b> p.160-161						

LED versions

projectors LED



**lyras 45** p.2-3  
**lyras 65 (24V)** p.4-5  
**lyras 65 (AC/240V)** p.6-7  
**lyras 130** p.8-9

suspensions LED

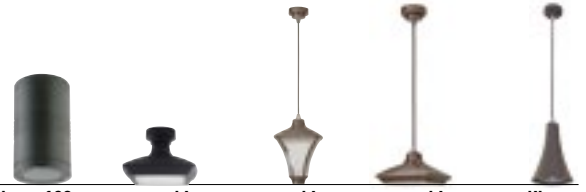

**lyras 130** p.8-9  
**morphis** p.80 / 84  
**morphis** p.76-77  
**morphis** p.80 / 84  
**liberty** p.88-89

wall recessed LED

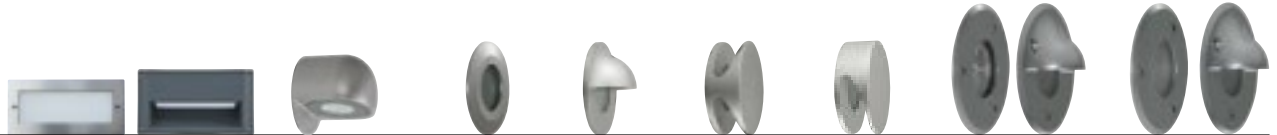

**brick light** p.22÷25  
**brick light** p.26-27  
**mira 45 LT** p.12  
**wall mira 45** p.14  
**wall mira 45** p.14  
**wall mira 45** p.15  
**wall mira 45** p.15  
**wall mira 65 (24V)** p.16-17  
**wall mira 65 (AC/240V)** p.18-19

ingrounds LED



**mira 45** p.28-29  
**mira 45** p.30  
**mira 45** p.30  
**mira 45** p.31  
**mira 65 (24V)** p.32-33  
**mira 65 (AC/240V)** p.34-35  
**mira 150** p.36-37  
**mira 220** p.38-39  
**mira 220** p.40-41



**tubo** p.50÷53  
**kubs** p.54-55  
**lako** p.56-57  
**beam** p.58-59  
**dolby 2** p.60-61  
**lyras 80** p.62-63  
**lyras 130** p.64-65  
**kami** p.96-97  
**kami** p.98-99  
**oko** p.100-101



**titano** p.108-109  
**neway** p.112-113  
**cervinia** p.148-149  
**luna** p.124-125  
**sunny** p.70÷73  
**morphis** p.86-87  
**ibis 2 LED** p.92-93  
**polos** p.120-121  
**polos** p.120-121  
**titano INOX** p.128-129

wall lights bollards and poles LED



**kubs** p.66-67  
**lako** p.68-69  
**sunny** p.70-71  
**sunny** p.72-73  
**morphis** p.74-75  
**morphis** p.76-77  
**morphis** p.78-79  
**morphis** p.80-81  
**morphis** p.82-83  
**morphis** p.84-85



**liberty** p.88-89  
**ibis 2** p.92-93  
**oko** p.102-103  
**titano** p.108-109  
**neway** p.114-115  
**polos** p.120-121  
**polos** p.120-121  
**luna** p.124-125  
**titano INOX** p.128-129  
**orion** p.132÷135

traditional LED



**romantica** p.192-193  
**augusta** p.196-197  
**rio** p.204-205  
**cipro** p.206  
**maiorca** p.207



# Projectors

- Proiettori
- Proyectores
- Projecteurs
- Projektoren

---

**flute** 10-11 p.  
**lyras 45** 2-3 p.

---

**lyras 65** 4-7 p.  
**lyras 130** 8-9 p.



Projectors

# Projectors

LANDA®

LANDA®  
illuminotecnica



◀ **flute**  
cod. 550VH70 nhg  
pagg. 10-11

▼ **lyras 130**  
cod. 461LS9X1N all  
project by: Moretti Luce - IT  
pagg. 8-9





LANDA®  
illuminotecnica

flute  
cod. 550VH70 nhg  
project by: Ansell Lighting - UK  
pagg. 10-11





LANDA®  
illuminotecnica

▲ **lyras 130**  
cod. 461LS9X1N nhg  
pagg. 8-9

◀ **lyras 65**  
cod. 4696LS5 inx  
pagg. 4-5

▶ **flute**  
cod. 550VH70 all  
pagg. 10-11







## Recessed

- Incassi
- Empotrables
- Encastrés
- Einbauleuchten

---

**brick light** 22÷27 p.  
**mira 150** 36-37 p.  
**mira 200** 42÷47 p.  
**mira 220** 38÷41 p.  
**mira 220** 48-49 p.

---

**mira 45** 28÷31 p.  
**mira 45 LT** 12-13 p.  
**mira 65 (24V)** 32-33 p.  
**mira 65 (AC/240V)** 34-35 p.

---

**wall mira 45** 14-15 p.  
**wall mira 65 (24V)** 16-17 p.  
**wall mira 65 (AC/240V)** 18-19 p.  
**round brick light** 20-21 p.



Recessed

# Recessed

LANDA®



▶ **dolby 2** (contemporary)  
cod. 457LS18X2N nhg  
project by Moretti Luce - IT  
pagg. 60-61

**brick light** (recessed)  
cod. 412L6  
project by Moretti Luce - IT  
pagg. 22-27



◀ **mira 45**  
cod. 5441LS2N inx  
project by: Telesys - Tunisia  
pagg. 28-29

▶ **mira 45 LT**  
cod. 4157LL2N brz  
pagg. 12-13





LANDA®  
illuminotecnica

illuminotecnica

A20 | RECESSED

▼ **mira 45** (recessed)  
cod. 5441LS2H inx  
pagg. 28-29

**dolby 2** (contemporary)  
cod. 457LS12X1H nhg  
pagg. 60-61

**brick light** (recessed)  
cod. 414L6  
pagg. 22÷27

project by Telesys - Tunisia

▲ **mira 150**  
cod. 5121LS9H  
pagg. 36-37

Lighting design: Apostolis Kouikoglou  
Photo: Chatzitzanos  
Place: Niriides Hotel Methoni Greece

▶ **mira 220**  
cod. 5512LL20N  
pagg. 38÷41

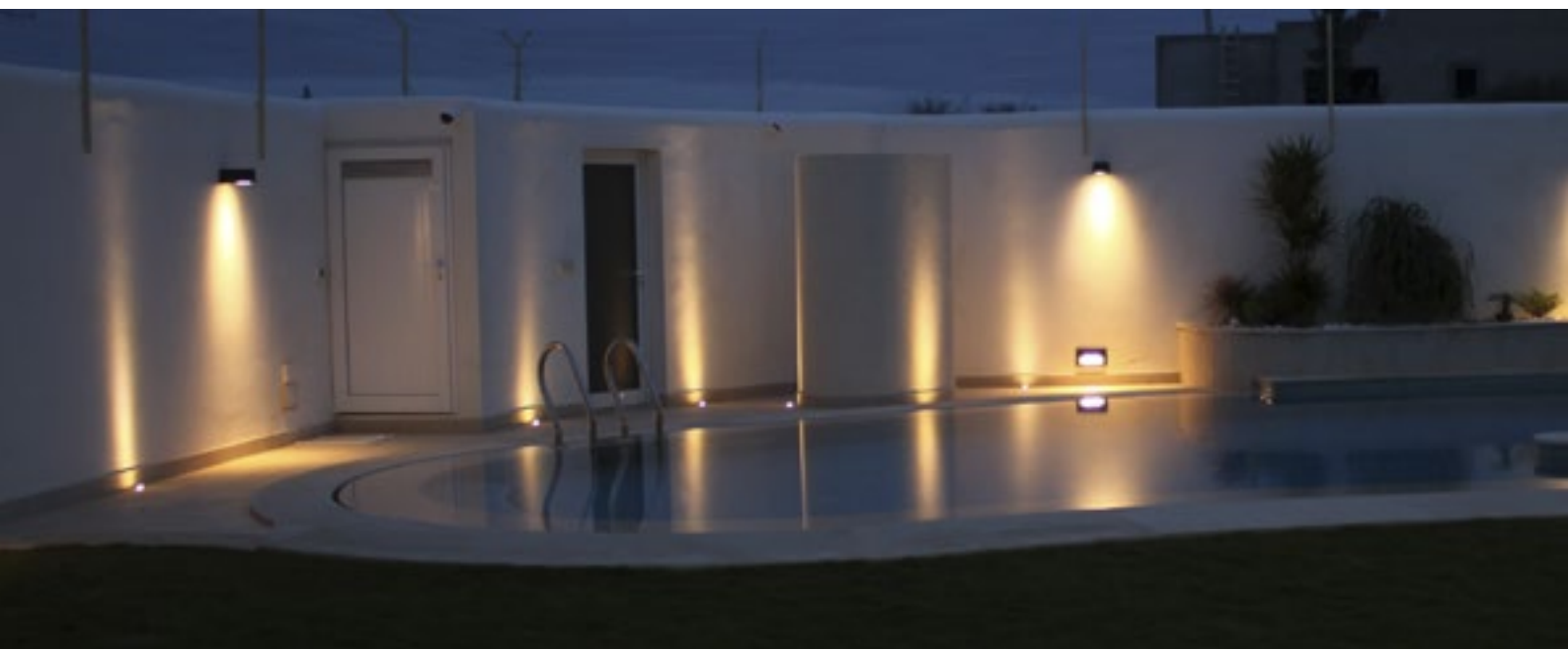

▶ **mira 150**  
cod. 5121LL12X1  
pagg. 36-37



▲ **mira 150**  
cod. 5111LL9N ngg  
pagg. 36-37



LANDA®  
illuminotecnica

▲ **mira 200**  
cod. 5023H70  
project by: Tesli - Russia  
pagg. 42÷47

◀ **mira 220**  
cod. 5521LL30N  
project by: Aric - F  
pagg. 38÷41

▶ **mira 200**  
cod. 5022H70  
project by: Aric - F  
pagg. 42÷47







LANDA®  
illuminotecnica

◀ **dolby 2** (contemporary)  
cod. 457LS18X2N nhg  
pagg. 60-61

**wall mira 45** (recessed)  
cod. 4151L2N inx  
pagg. 12÷15

project by: Moretti Luce - IT

▶ **round brick light**  
cod. 417GU10M  
pagg. 20-21

▼ **brick light**  
cod. 412L6  
project by: Cristher - ES  
pagg. 22÷27





LANDA®  
illuminotecnica

▲ **mira 200**  
cod. 5023H35  
project by: Aric - F  
pagg. 42÷47

▶ **mira 220**  
cod. 5521LS30N  
project by: ELTOR - HR  
pagg. 38÷41





# Contemporary

- Contemporanei
- Contemporaneo
- Contemporaines
- Zeitgenossen

---

**accessori pali** 159 p.  
**acqua** 152-153 p.  
**beam** 58-59 p.  
**cervinia** 148÷151 p.  
**colonna 52** 142-143 p.  
**colonna 76** 144-145 p.  
**dolby 2** 60-61 p.  
**kami** 96-99 p.  
**kubs** 54-55 / 66-67 p.  
**ibis 2** 92÷95 p.

---

**ivanhoe** 90-91 p.  
**lako** 56-57 / 68-69 p.  
**lampara INOX** 146-147 p.  
**liberty** 88-89 p.  
**luna** 124÷127 p.  
**lyras 80** 62-63 p.  
**lyras 130** 64-65 p.  
**morphis** 74÷87 p.  
**neway** 112÷117 p.  
**oko** 100÷105 p.

---

**orion** 132÷135 p.  
**orion INOX** 136÷139 p.  
**pali beta** 154÷157 p.  
**pali liberty** 158 p.  
**polos** 118÷123 p.  
**sunny** 70-73 p.  
**titano** 106÷111 p.  
**titano INOX** 128÷131 p.  
**tubo** 50÷53 p.  
**urano** 140-141 p.



Contemporary

# Contemporary

LANDA®



◀ **kami**  
cod. 9010L12H nhg  
pagg. 96-97

▼ **polos**  
cod. 403.10L10N nhg  
pagg. 68÷71





◀ **kubs**  
cod. 404LL8X1H nhg  
cod. 404LMA4X2H nhg  
pagg. 54-55

**sunny**  
cod. 407.075L12H nhg  
pagg. 70-71

▲ **beam**  
cod. 456LS10N nhg  
pagg. 58-59



LANDA®  
luminotecnica

▲ **lako**  
cod. 409.018L7HX2 nhg  
pagg. 56-57

cod. 409.060L7HX2 nhg  
pagg. 68-69

▼ **titano**  
cod. 824.100L10 ral9006  
project by: Martin Fukna - OMS - SK  
pagg. 106÷109





▲ **tubo**  
 cod. 6001.100L10N  
 cod. 00A6001.01  
 cod. 00A6001.03  
 pagg. 50÷53

► **kubs**  
 cod. 404LMA4X2H nhg  
 pagg. 54-55

**sunny**  
 cod. 407.075L12H nhg  
 pagg. 70-71







◀ **oko**  
▼ cod. 406.L6 nhg  
pagg. 100-101

cod. 406.095LS12 nhg  
pagg. 102-103





▲ **ibis 2**  
 cod. 451L20N.050 nhg  
 pagg. 92-93

▼ **kubs**  
 cod. 404LL8X1H nhg  
 cod. 404LMA4X2H nhg  
 pagg. 54-55

cod. 404.070L4X2H nhg  
 pagg. 66-67

LANDA®  
 illuminotecnica



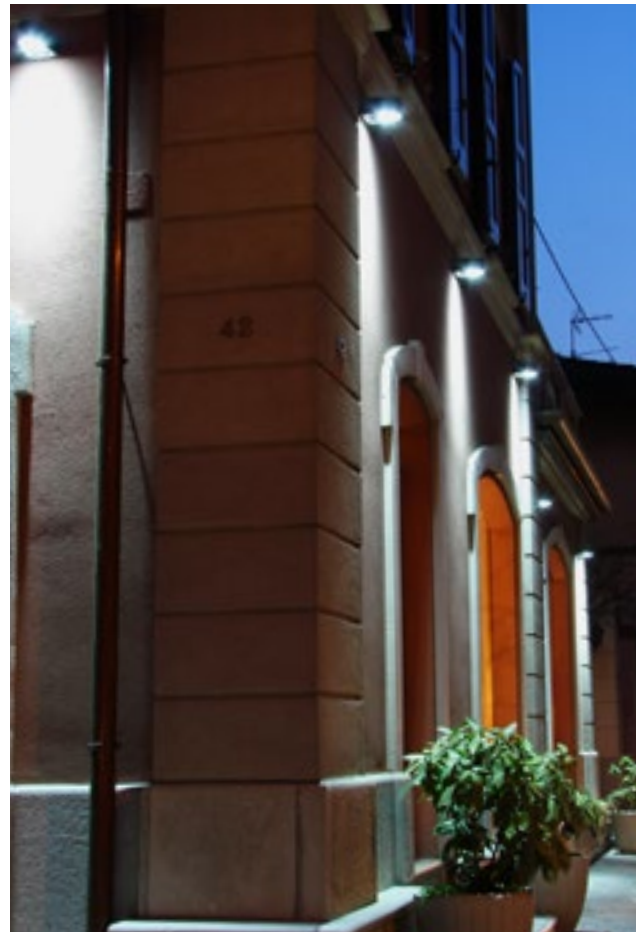

▲ **dolby 2**  
cod. 457LS12X1N nhg  
pagg. 60-61

**LANDA®**  
illuminotecnica

◀ **dolby 2**  
cod.457LS18X2N nhg  
project by: Moretti Luce - IT  
pagg. 60-61

▼ **ibis 2**  
cod. 451.050 all  
project by:  
Creative Solution - GR  
pagg. 94-95





- ▲ **titano**  
cod. 824.100L10 ral9006  
pagg. 108-109
- mira 220**  
cod. 5521LL30N  
pagg. 40-41
- project by: Martin Fukna - OMS - SK

- ▶ **polos**  
cod. 402.090H35 all  
project by: Eltor - HR  
pagg. 118-119





LANDA®  
illuminotecnica

► **cervinia** (contemporary)  
9006 ngg  
pagg. 148÷151

**dolby 2** (contemporary)  
cod. 457LS18X2N nhg  
pagg. 56-57

**ibis 2** (contemporary)  
cod. 451.075 nhg  
pagg. 94-95

**mira 45** (recessed)  
cod. 5441L2N inx  
pagg. 28-29

project by: Telesys - Tunisia

▼ **ivanhoe**  
cod. 470.045 nhg  
project by: Illuminarte - BG  
pagg. 90-91

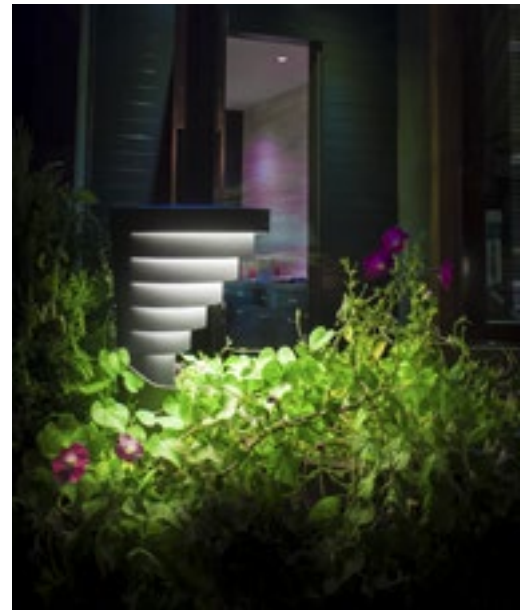

► **morphis**  
cod. 177.240L24 ngr  
project by: KSR Lighting UK  
pagg. 74÷85

◀ **morphis**  
cod. 177.200L24 ngr  
pagg. 74÷85

**maiorca**  
cod. 421PL13  
pagg. 207

project by: KSR Lighting UK



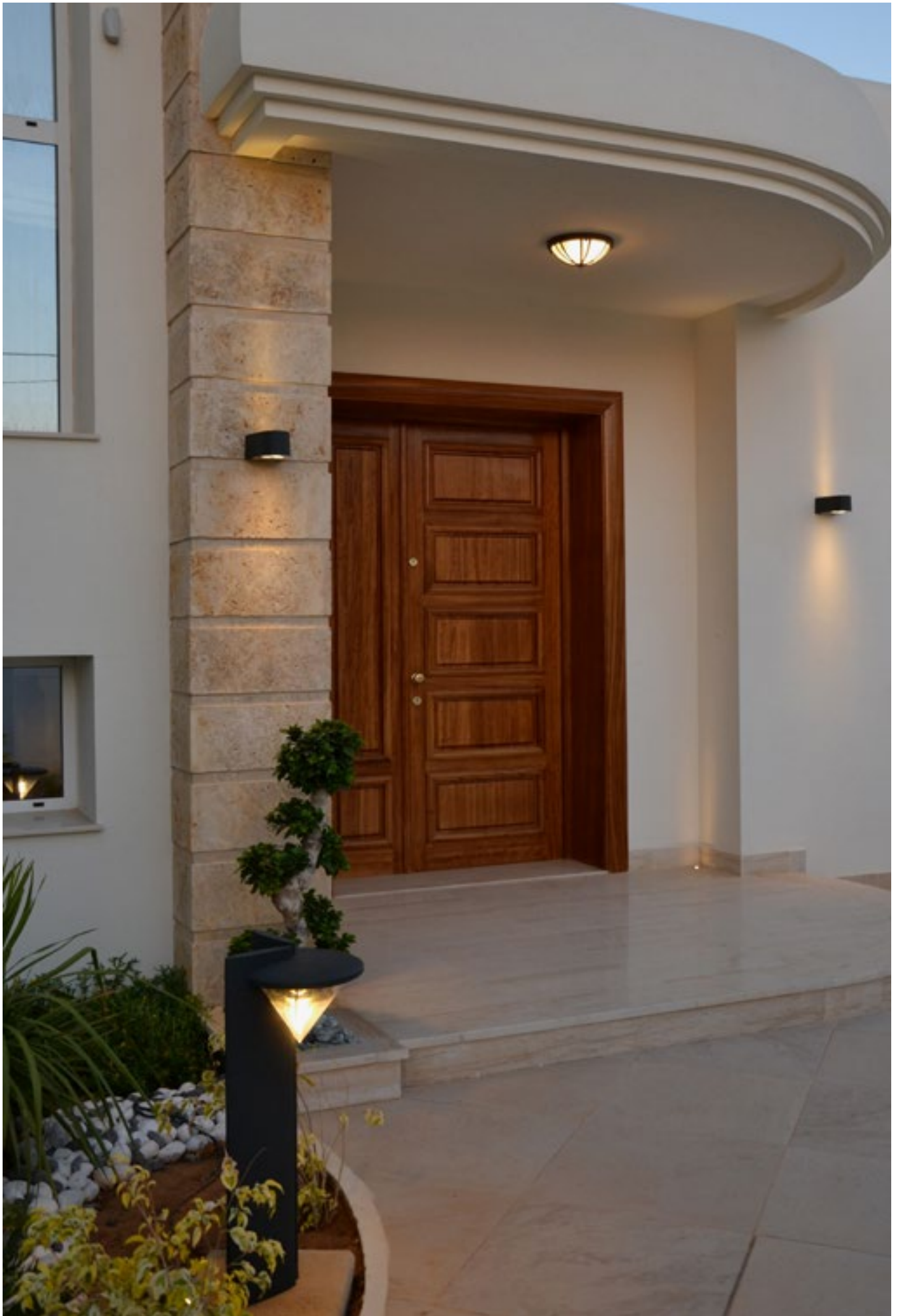



LANDA®  
illuminotecnica

▶ **lyras 130** (contemporary)  
cod. 460LS9X2N  
pagg. 64-65

**ibis 2** (contemporary)  
cod. 451.075 nhg  
pagg. 94-95

**mira 220** (recessed)  
cod. 552LL20N  
pagg. 38-39

project by: Ansell Lighting - UK



▲ **polos**  
cod. 402.035 nhg  
pagg. 118-119  
project by: Vint Doel - MK

▶ **lyras 130**  
cod. 460LL9X2N nhg  
pagg. 64-65







▲ **orion INOX**  
cod. 800.075  
project by: Cristher - ES  
pagg. 136-137

◀ **polos**  
cod. 4021.090F24 all  
project by: Prima Plus - RO  
pagg. 118-119

▶ **morphis**  
cod. 177.300 ngr  
project by: SI - RU  
pagg. 78-79





▲ **sunny**  
 cod. 408.00L12  
 pagg. 70÷73

▶ **morphis**  
 cod. 177.33L24H ngr  
 project by: Martin Fukna - PMR connection SK  
 pagg. 78-79

◀ **titano**  
 cod. 822.100L10 ral9006  
 project by: Martin Fukna - OMS - SK  
 pagg. 106÷109

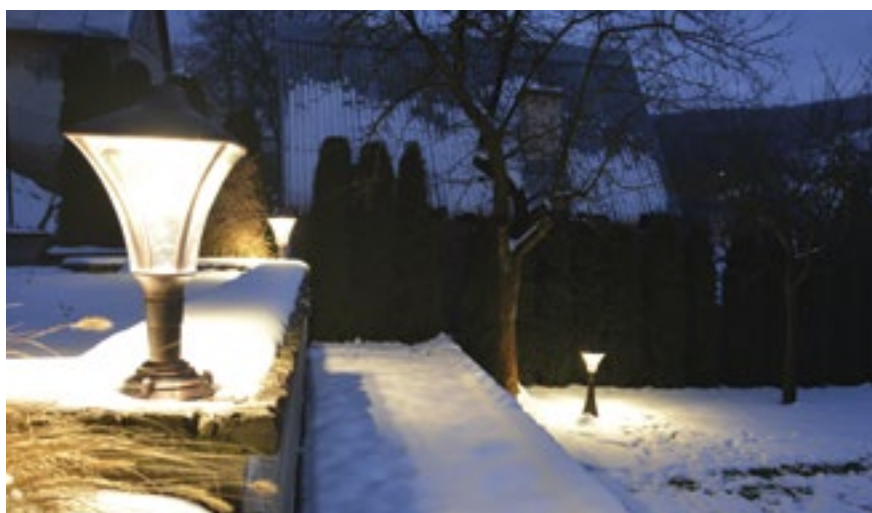



LANDA®

illuminotecnica

▶ **oko**

cod. 406.095LS12H nhg  
pagg. 100÷105

**dolby 2**

cod. 457LS12X1N nhg  
pagg. 60-61

project by Telesys - Tunisia

◀ **lyras 80**

cod. 465GU10X2 nhg  
project by: KSR Lighting UK  
pagg. 62-63



▲ **dolby 2**

cod. 457LS18X2N nhg  
project by: Moretti Luce - IT  
pagg. 60-61

◀ **morphis**

cod. 177.095 ngr  
project by: Total Strada - RO  
pagg. 74÷85

▶ **luna**

cod. 440K090P1 nhg  
pagg. 124÷127



CONTEMPORARY

A43

LANDA®  
illuminotecnica

▶ **ivanhoe**  
cod. 470F26.075 nhg  
project by: KSR Lighting - UK  
pagg. 90-91



▶ **titano INOX**  
cod. 822.045  
project by: LCD GMBH - DE  
pagg. 128÷131



▲ **morphis**  
cod. 176L24.02 ngr  
pagg. 74÷85

▼ **polos**  
cod. 4031.090F24 nhg  
project by: Tesli - Russia  
pagg. 120÷123

▶ **polos**  
cod. 402K090F18 nhg  
project by: KSR Lighting UK  
pagg. 118-119





▲ **polos**  
cod. 4031.115L10 nhg  
project by: KSR Lighting UK  
pagg. 120÷123

▼ **liberty**  
cod. 170LL13.P2 bgg  
project by: KSR Lighting UK  
pagg. 88-89

▶ **neway**  
cod. 405.075 nhg  
project by: Ansell Lighting - UK  
pagg. 112÷117



A45





# Traditional

- Tradizionale
- Tradicional
- Traditionnel
- Traditionell

---

**serie pali** 160-161 p.

**amalfi** 184-185 p.  
**amalfi maxi** 186-187 p.  
**amalfi mini** 182-183 p.  
**augusta** 196÷199 p.  
**cipro** 206 p.  
**firenze** 188-189 p.  
**lampara** 168-169 p.

---

**lampara INOX** 146-147 p.

**maiorca** 207 p.  
**monaco** 190-191 p.  
**nizza** 200-201 p.  
**oslo** 203 p.  
**parigi** 164-165 p.  
**parigi maxi** 166-167 p.  
**parigi mini** 162-163 p.

---

**pisa** 202 p.

**rio** 204-205 p.  
**romantica** 192÷195 p.  
**saturno** 170-171 p.  
**sirio** 172-173 p.  
**toscana** 174÷177 p.  
**venezia** 180-181 p.  
**venezia mini** 178-179 p.



Traditional

# Traditional

LANDA®





▶ **saturno**  
cod. 110.P3 ngg  
project by: Art Light - HU  
pagg. 170-171

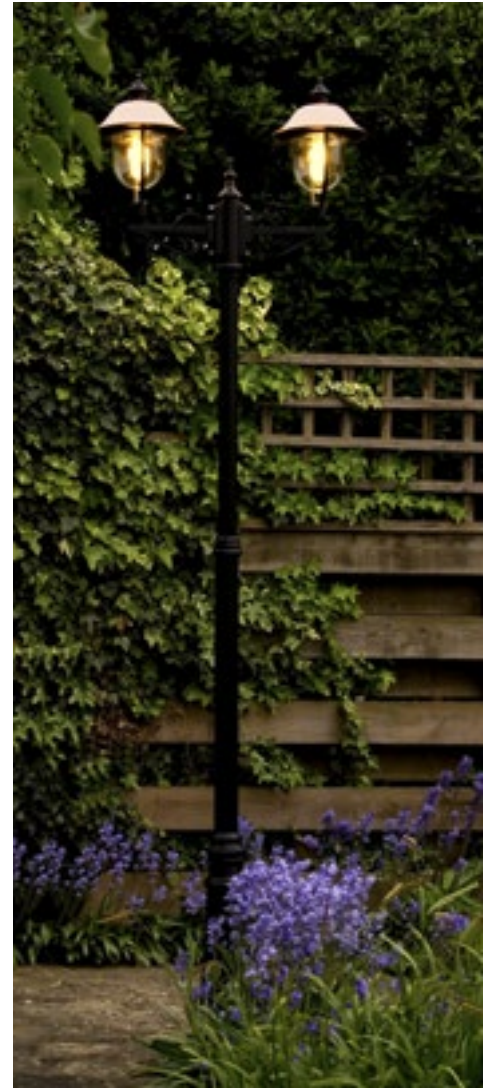

▲ **amalfi maxi**  
cod. 323.PF9T3 ngg  
project by: Efect Lighting - RO  
pagg. 182÷187

▼ **nizza**  
cod. 390.44 bgg  
project by: LCD GMBH - DE  
pagg. 200-201

▲ **romantica**  
cod. 350APF8T2 nga  
project by: KSR Lighting - UK  
pagg. 192÷195



◀ **pisa**  
cod. 300.44 ngg  
project by: LCD GMBH - DE  
pagg. 202





◀ **venezia**  
cod. 312.PR6 ngv  
project by: Moretti Luce - IT  
pagg. 178÷181



◀ **augusta**  
cod. 360APR5 nga  
pagg. 196÷199

▲ **amalfi maxi**  
cod. 321.PR7T2 ngg  
project by: WEBCOM - RO  
pagg. 182÷187



◀ **nizza**  
cod. 391.PF7 ngv  
project by: Moretti Luce - IT  
pagg. 200-201

▶ **cervinia** (contemporary)  
cod. 9002 ngr  
pagg. 148÷151

**toscana** (traditional)  
cod. 165.01 ngr  
pagg.174÷177

project by: Aulix - CZ





LANDA®  
illuminotecnica

▲ **romantica**  
cod. 350.01 bgg  
project by: Forma Art - RU  
pagg. 192÷195

▼ **amalfi maxi**  
cod. 321.PR7T2 ngg  
project by: WEBCOM - RO  
pagg. 182÷187





LANDA®

illuminotecnica

▲ **parigi**

cod. 371.01 nng  
project by: Creative Solution - GR  
pagg. 162÷167

▼ **sirio**

cod. 150.P1.12 nhg  
Lighting design : Apostolis Kouikoglou  
Photo : Chatzitzanos  
Place : Niriides Hotel Methoni Greece  
pagg. 172-173





▲ **toscana** (traditional)  
 cod. 160.01 ngg  
 project by: Prolux - HU  
 pagg.174÷177

LANDA®  
 illuminotecnica



▲ **monaco**  
 cod. 340.33 bgg  
 pagg. 190-191

▶ **lampara**  
 cod. 100A01 ngr  
 project by: Martin Fukna  
 PMR connection SK  
 pagg. 168-169



# news

## LED



ENERGY SAVING

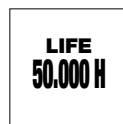

LONG LIFE

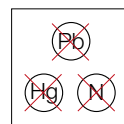

ECOLOGICAL



RECYCLABLE

COLOURS  
AVAILABLE

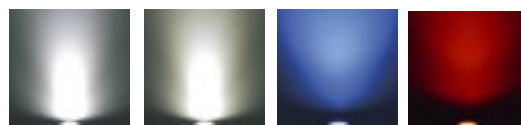

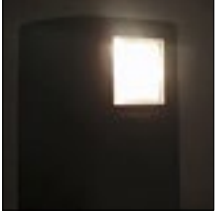

**kubs**  
cod. 404

powered by  
Citizen CLL104 LED  
8W - 610LM

p.66

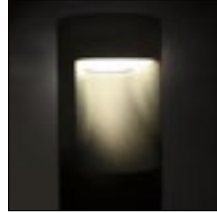

**lako**  
cod. 409

powered by  
Seoul® Semiconductor 2525 LED  
7W - 600LM

p.68

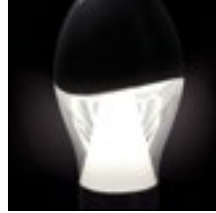

**neway**  
cod. 405

powered by  
Citizen Electronics® LED  
10 W - 1300LM

p.114





# news

## sensor product



### SPECIFICATIONS

Detection range:	160°
Power supply:	230-240 V
Power frequency:	50/60Hz
Reach:	1-8 m (Ø), adjustable
Time setting:	5 sec to 15 min
Light control:	2-2000 LUX
Diffuser:	opal polycarbonate



**morphis**  
cod. 175  
p.86-87



**luna**  
cod. 440  
p.126-127



**cervinia**  
cod. 9008  
p.148-149



**cervinia**  
cod. 9006  
p.150-151



**acqua**  
cod. 9100  
p.152-153



**rio**  
cod. 425  
p.204-205



**maiorca**  
cod. 421B  
p.207

# prodotti

products  
produits  
productos  
Produktlinien



### luce e decoro

light and decoration  
lumière et décoration  
luz y adorno  
Licht und Dekor



### 360 gradi di luce nuova

360 degrees of modern lighting  
360 degrés de nouvelle lumière  
360 grados de nueva luz  
Rundumlicht 360°



### meticolosa scelta dei materiali

top quality materials  
choix méticuleux des matériaux  
meticulosa escogida de los materiales  
Materialien bester Qualität



### diverse elettrificazioni

different electrifications  
différentes alimentations  
varias modalidades de electrificación  
Verschiedene Elektrifizierungen



### personalizzazioni laser

laser personalization  
personnalisation laser  
personalizaciones laser  
Individualisierung durch Laserschnitt

I prodotti Landa variano dal tradizionale al moderno e tecnico, tutti realizzati con materiali accuratamente selezionati e sottoposti ai più moderni trattamenti che ne garantiscono la più elevata resistenza agli agenti esterni.

Landa's products range from Traditional to Modern as well as Technical and are all manufactured with carefully selected materials and submitted to the most up to date treatments in order to guarantee the highest resistance to atmospheric agents.

Les produits LANDA varient du style traditionnel au moderne et technique. Tous les articles sont réalisés à partir de matériaux soigneusement sélectionnés et soumis aux traitements les plus modernes pour en assurer la résistance maximum aux agents atmosphériques.

Los productos Landa varían desde lo tradicional a lo moderno y técnico. Todas nuestras piezas están hechas con materiales escogidos con esmero y tratados con los más modernos métodos de trabajo que garantizan la más elevada resistencia.

Landa bietet verschiedene Produktlinien, von traditionell über modern bis technisch. Landa verwendet nur Materialien, die sorgfältig geprüft werden und den modernsten Verarbeitungen entsprechen, um eine hohe Wetterbeständigkeit zu erreichen.



# Country

## COLLECTION

### **Il principio è semplice: verniciare decorando**

Film transfer prestampato con pigmenti organici fotosensibili e resine di cellulosa, avvolto interamente sul profilo. Il metodo di decorazione o stampa utilizzato è quello per sublimazione o stampa a caldo. La sublimazione è il passaggio fisico di una materia dallo stato solido a quello aeriforme senza passare dallo stato liquido. Processo produttivo non inquinante: il trasferimento è pulito e secco, senza residui di materiale colorante o residui chimici, acqua di rifiuto: il personale, i boschi, le montagne e i mari ringraziano.

Corpo: alluminio estruso

Test in nebbia salina: > 1500 ore

### **The principle is simple: coating decorating**

Pre-printed film transfer with organic photo sensitive pigments and cellulose resin, completely wrapped around the profile. The decoration or printing method used is the sublimation or heat printing. Sublimation is the physical process: a material changes from a solid condition into a gas condition without ever turning into a liquid condition. Production process is not polluting: the transfer is clean and dry, no colour material waste, no chemical waste, no water waste: personal, woods, mountains and seas are grateful.

Body: aluminium extruded

Test in saline mist: > 1500 hours

### **Le principe est simple: peindre en décorant**

Le film pour transfert pré-imprimé avec pigments organiques photosensibles et résine de cellulose enveloppe entièrement le profil. La méthode de décoration ou d'impression utilisée est celle de la sublimation ou impression à chaud. La sublimation est le passage physique d'une matière de l'état solide à l'état gazeux sans passer par l'état liquide. C'est un procédé de production non polluant: le transfert est précis et sec, sans résidus de matériels colorants, chimiques ou d'eau: le personnel, les bois, les montagnes et les mers remercient.

Corps: aluminium extrudé

Test dans le brouillard salin: > 1500 heures



# new color oxide

## El principio es sencillo: pintar decorando

La película plástica ya estampada con pigmentos orgánicos fotosensibles y resinas de celulosa, envuelven completamente el perfil. El método de decoración o impresión utilizado es el de sublimación o impresión a calor. La sublimación es el paso físico de una materia del estado sólido al gaseoso sin pasar por el estado líquido. Proceso productivo no contaminante: él es limpio y seco, sin residuos de material colorante u residuos químicos, agua de residuo: el personal, los bosques, las montañas y los mares agradecen.

Cuerpo: aluminio extrusionado

Test en neblina salinizada: > 1500 horas

## Das Prinzip ist einfach: lackieren und dekorieren

Es wird zuerst ein Kunststofffilm mit organischen, lichtempfindlichen Pigmenten und Zellharz bedruckt, mit dem das ganze Profil eingehüllt wird. Die Dekorations- oder Druckmethode nennt man Sublimation oder Warmumformen. Sublimation ist der physische Übergang eines Stoffes vom festen Zustand zum gasförmigen Zustand, ohne einen flüssigen Zustand zu haben. Das ist ein umweltfreundlicher Herstellungsprozess, der sauber und trocken ist, ohne Materialrückstand, Chemierückstand und Abwasser. Die Menschen, der Wald, die Berge und die Meere danken uns dafür.

Körper: aluminium

Test Korrosiongeschützt: > 1500 Stunden



# new color oxide

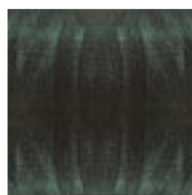

## ngv

nero/verde - black/green  
noir/vert - negro/verde  
Schwarz/Grün



## nga

nero/argento - black/silver  
noir-argent - negro/plata  
Schwarz/Silber

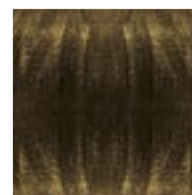

## ngo

nero/oro - black/gold  
noir/or - negro/oro  
Schwarz/Gold

Una vasta gamma di colori opzionali . Componenti cromatizzati garantiti 900 ore in nebbia salina.

A wide range of optional colours is available. Chromatised parts are guaranteed 900 hours in saline mist.

Une vaste gamme de couleurs optionnelles. Composants chromatisés garantis 900 heures dans le brouillard salin.

Extenso surtido de colores a escoger. Piezas cromatizadas y garantizadas con 900 horas en neblina salinizada.

Ein große Auswahl an optionalen Farben. Korrossionsbeständigkeit der chromatisierten Teile 900 Stunden im Salzwasser-Nebel getestet.

neway  
cod. 405.100 nhg  
Thanks to Ansell Lighting - UK  
pagg. 112-117

**colori**  
colours  
couleurs  
colores  
farben



A61



**ngr**  
nero/rame - black/copper  
noir/cuivre - negro/cobre  
Schwarz/Kupfer



**ngg**  
nero - black - noir  
negro - Schwarz



**bgg**  
bianco - white - blanc  
blanco - Weiß



**all**  
grigio metallizzato  
metal grey - gris métallique  
gris metalizado - Metallgrau

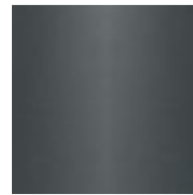

**nhg**  
grafite - graphite  
graphite - grafite  
Graphit



**oxi**  
oxide

**ANODIZED FINISHING:**



**inx**  
inox - stainless steel  
acier - acero - Edelstahl



**brz**  
bronzo - bronze - bronze  
bronze - Bronze

# accessori

accessoires  
accessoires  
accesorios  
Zubehör



code **OODEC**



Liquido per sgrassare, pulire e proteggere gli articoli in acciaio inox AISI 316L  
Maintenance kit for polishing and protecting products in stainless steel AISI 316L  
Liquide pour dégraisser, nettoyer et protéger les articles en acier inoxydable AISI 316L  
Líquido para desengrasar, pulir y proteger los artículos de acero inoxidable AISI 316L  
Flüssigkeit zur Entfettung, Reinigung und zum Schutz von Edelstahloberflächen AISI 316L

A62



code **0404M009**  
Single connection IP68



code **0404M010**  
code **0404M011**  
Single connection IP68



code **0404M004**  
Single connection IP68

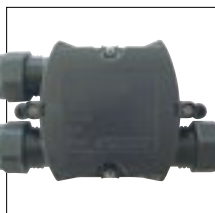
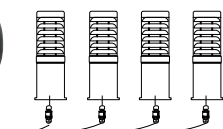

code **0404M003**  
Loop in loop out IP68

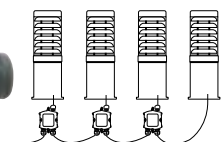

lampara INOX  
cod. 9500.PA6T2  
Thanks to Pipbrothers - BG  
pagg. 146-147

Projectors

Recessed

Contemporary

Traditional

LANDA®  
illuminotecnica



CATALOGUE

luce italiana  
2016|17



# lyras 45

**LED**  
powered by  
Seoul® Semiconductor Z5M

simmetrico  
symmetric  
symétriques  
simétrico  
symmetrisch

example code:  
art. LED anodized  
4692 LS2 H inx

art.  
**4692**

design Ufficio Tecnico Landa

corpo alluminio estruso  
anodizzato  
body in extruded anodized  
aluminium  
corps en aluminium extrudé  
anodisé  
cuerpo en aluminio  
extrusionado y anodizado  
Körper aus eloxiertem  
fließgepresst Aluminium

diffusore vetro trasparente  
e opale  
diffuser glass transparent  
and opal  
diffuser verre transparent  
et opale  
difusor vidrio transparente  
y ópalo  
Diffuser Glas klar und opal

PROJECTORS  
2

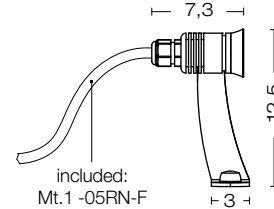

FOR TECHNICAL DETAILS VISIT  
[www.landa.it](http://www.landa.it)

IP67

art.	LUX 1mt	art.	LUX 1mt	art.	LUX 1mt	W	V	Type	Ra
4692LS2N	1600	4692LL2N	280	4692L2N	40	2	24	4000K 160LM	80
4692LS2H	1600	4692LL2H	280	4692L2H	40			3000K 160LM	80

Transformer available:

cod. 0409BT014 to connect up to **5** pieces – GE LIGHTING IP67 24V c.c. 12W  
cod. 0409BT015 to connect up to **10** pieces – GE LIGHTING IP67 24V c.c. 25W

Transformer on request:

cod. 0409BT016 to connect up to **42** pieces – GE LIGHTING IP67 24V c.c. 100W

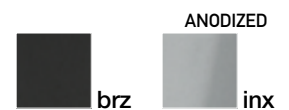

ELECTRIFICATION

**LED**

dettagli / details / details  
detalles / details:  
p.A54 - A55

Energy efficiency classes

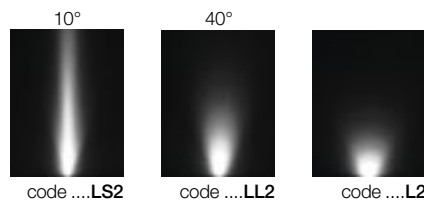

A++ ÷ A

lyras 45 (24V)

NEW  
Projectors

Recessed

Contemporary

Traditional



PROJECTORS

3



Accessories on request:



code 0404M009  
Single connection IP68

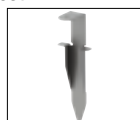

code 00A469  
Mounting spike



serie/series

# lyras 65

**LED**  
powered by  
Seoul® Semiconductor Z5M

simmetrico  
symmetric  
symétriques  
simétrico  
symmetrisch

example code:  
art. LED anodized  
4696 L5 N inx

art.  
**4696**

design Ufficio Tecnico Landa

corpo alluminio estruso  
anodizzato  
body in extruded anodized  
aluminium  
corps en aluminium extrudé  
anodisé  
cuerpo en aluminio  
extrusionado y anodizado  
Körper aus eloxiertem  
fließgepresst Aluminium

diffusore vetro trasparente  
e opale  
diffuser glass transparent  
and opal  
diffuser verre transparent  
et opale  
difusor vidrio transparente  
y ópalo  
Diffuser Glas klar und opal

PROJECTORS  
4



4696 inx



4696 brz

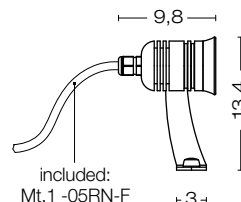

included:  
Mt. 1 -05RN-F



FOR TECHNICAL DETAILS VISIT  
[www.landa.it](http://www.landa.it)

IP67

art.	LUX 1mt	art.	LUX 1mt	art.	LUX 1mt	W	V	Type	Ra
4696LS5N	3740	4696LL5N	700	4696L5N	124	5	24	4000K 480LM	80
4696LS5H	3740	4696LL5H	700	4696L5H	124	5	24	3000K 480LM	80

Transformer available:

cod. 0409BT014 to connect up to 2 pieces – GE LIGHTING IP67 24V c.c. 12W  
cod. 0409BT015 to connect up to 4 pieces – GE LIGHTING IP67 24V c.c. 25W

Transformer on request:

cod. 0409BT016 to connect up to 16 pieces – GE LIGHTING IP67 24V c.c. 100W



ELECTRIFICATION

**LED**

dettagli / details / details  
detalles / details:  
p.A54 - A55

Energy efficiency classes

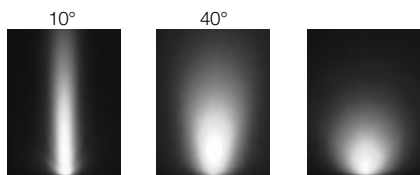

code ....LS5

code ....LL5

code ....L5

A++ ÷ A

lyras 65 (24V)

NEW

Projectors

Recessed

Contemporary

Traditional



PROJECTORS

5



Accessories on request:



code 0404M009  
Single connection IP68

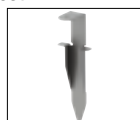

code 00A469  
Mounting spike



serie/series

# lyras 65

# LED

powered by  
Philips Luxeon H50-2  
AC direct connection  
220/240V  
Transformer not required

simmetrico  
symmetric  
symétriques  
simétrico  
symmetrisch

example code:

art. LED anodized  
4699 L5 H brz

art.  
**4699**

design Ufficio Tecnico Landa

corpo alluminio estruso  
anodizzato  
body in extruded anodized  
aluminium  
corps en aluminium extrudé  
anodisé  
cuerpo en aluminio  
extrusionado y anodizado  
Körper aus eloxiertem  
fließgepresst Aluminium

diffusore vetro trasparente  
e opale  
diffuser glass transparent  
and opal  
diffuser verre transparent  
et opale  
difusor vidrio transparente  
y ópalo  
Diffuser Glas klar und opal

PROJECTORS  
6



4699 inx



4699 brz

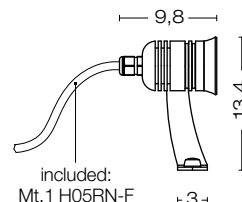

included:  
Mt.1 H05RN-F



FOR TECHNICAL DETAILS VISIT  
[www.landa.it](http://www.landa.it)

IP67

art.	LUX 1mt	°	art.	LUX 1mt	°	art.	LUX 1mt	W	V	Type	Ra
4699LS5H	2070	15°	4699LL5H	525	30°	4699L5H	92	5	220-240	3000K 400LM	80



ELECTRIFICATION

# LED

dettagli / details / details  
detalles / details:  
p.A54 - A55

Energy efficiency classes

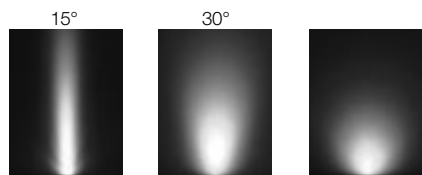

code ....LS5      code ....LL5      code ....L5

A++ ÷ A

# lyras 65 (AC/240V)

Projectors

Recessed

Contemporary

Traditional



7 | PROJECTORS



Thanks to Artic - F



Accessories on request:



code 0404M009  
Single connection IP68



code 00A469  
Mounting spike



serie/series

# lyras 130

# LED

simmetrico  
symmetric  
symétriques  
simétrico  
symmetrisch

example code:

art. LED 10° | colour |  
461 LS9 H nhg

art. electrification | colour |  
461 GU5.3 all

art.  
**461**  
**463**

design A. Dolcetti

OHIM:  
European patent No.  
000346366-0003



PROJECTORS  
8

corpo alluminio pressofuso  
body in die casting aluminium  
corps en aluminium moulé  
sous pression  
cuerpo aluminio inyectado  
Körper aus Aluminium-  
Druckguss

diffusore vetro trasparente  
diffuser glass transparent  
diffuser verre transparent  
difusor vidrio transparente  
Diffuser Glas klar

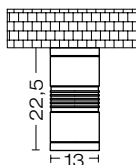
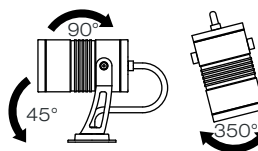
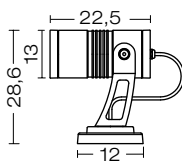

FOR TECHNICAL DETAILS VISIT  
[www.landa.it](http://www.landa.it)

IP66

art.	art.	LED	W	V	Type	LUX 1mt
461LS9X1N	463LS9X1N	10°	12	240	4000K 840LM	10800
461LS9X1H	463LS9X1H	10°	12	240	3000K 840LM	10800
461LL9X1N	463LL9X1N	45°	12	240	4000K 840LM	720
461LL9X1H	463LL9X1H	45°	12	240	3000K 840LM	720
461GU5.3	463GU5.3		1x50	12	no transformer	GU5,3
461E27	463E27	-60°/+60°	1x21			E27

**LED**  
powered by  
Seoul® Semiconductor Z5M  
Transformer included

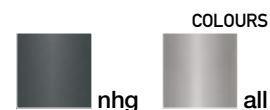

ELECTRIFICATION

# LED

dettagli / details / details  
detales / details:  
p.A54 - A55

Energy efficiency classes

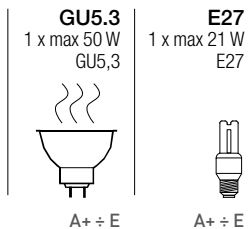
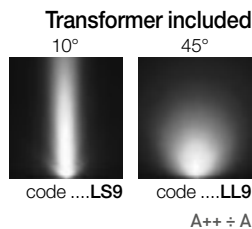

lyras 130

NEW

Projectors

Recessed

Contemporary

Traditional



9 | PROJECTORS



Accessories on request:

Also available with:



cod. **0201008B**  
vetro opale/opal glass/  
verre opale/vidrio ópalo/  
Glas opal



code **00K460.02**  
Reflector for  
art. **461-463**



code **00A465**  
Mounting spike for  
art. **461**



code **00K460.01**  
Visor for  
art. **461-463**





serie/series

# flute



simmetrico  
symmetric  
symétriques  
simétrico  
symmetrisch



asimmetrici aggiustabili  
Adjustable reflectors  
asymétriques ajustables  
Refletores ajustables  
asymmetrisch und regelbar

example code:

| art. | electrification | colour |  
550 H70 all

art.  
**550**

design Teseo Berghella

OHIM:  
patent No.  
000659917-0001



PROJECTORS  
10

corpo alluminio pressofuso  
body in die casting aluminium  
corps en aluminium moulé  
sous pression  
cuerpo aluminio inyectado  
Körper aus Aluminium-  
Druckguss

diffusore vetro trasparente  
diffuser glass transparent  
diffuser verre transparent  
difusor vidrio transparente  
Diffuser Glas klar



550H70 nhg

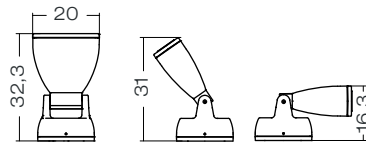

550VH70 all

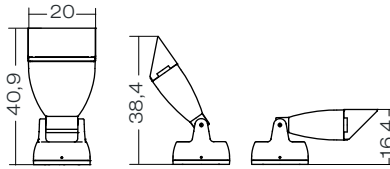

FOR TECHNICAL DETAILS VISIT  
[www.landa.it](http://www.landa.it)

IP65

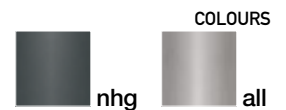
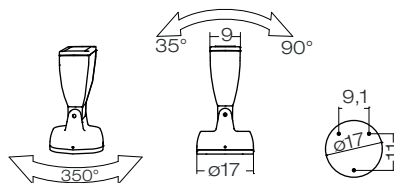

ELECTRIFICATION

**H70**  
1 x 70 W  
RX7s  
metal halide



A+ ÷ C

Colored Bulb - BLV  
visit: [www.blv-licht.com](http://www.blv-licht.com)

Energy efficiency classes

# flute

Projectors

Recessed

Contemporary

Traditional



ENERGY  
SAVING

PROJECTORS

11



...nhg



...all

Accessories on request:

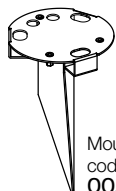

Mounting spike  
code  
00A550P

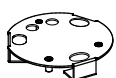

Mounting plate  
code 00A550R



# mira 45 LT

# LED

powered by  
Seoul® Semiconductor Z5M

simmetrico  
symmetric  
symétriques  
simétrico  
symmetrisch

example code:  
| art. | LED |  | anodized |  
4157 LL2 H inx

art.  
**4157**

design Ufficio Tecnico Landa

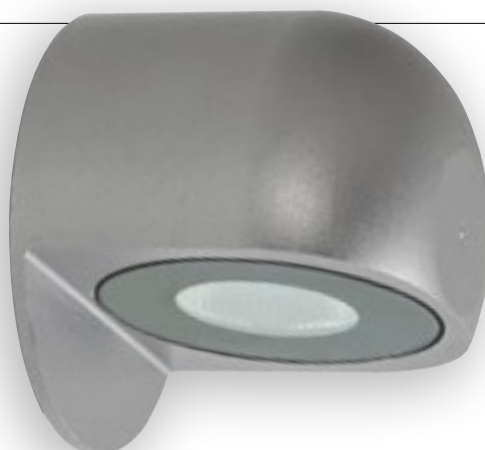

corpo alluminio estruso  
anodizzato  
body in extruded  
aluminium  
corps en aluminium extrudé  
anodisé  
cuerpo en aluminio  
extrusionado y anodizado  
Körper aus eloxiertem  
fließgepresst Aluminium

diffusore policarbonato  
trasparente  
diffuser transparent  
polycarbonate  
diffuser polycarbonate  
transparent  
difusor policarbonato  
transparente  
Diffuser Polykarbonat klar

12 RECESSED



...brz



...inx

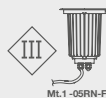
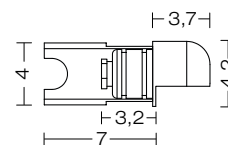
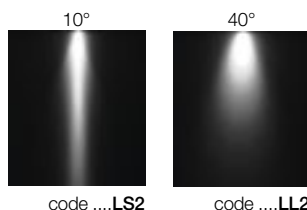

FOR TECHNICAL DETAILS VISIT  
[www.landa.it](http://www.landa.it)

IP66

art.	LUX 1mt	beam	art.	LUX 1mt	beam	W	V	Type	Ⓛ	Ra
4157LS2N	1600	10°	4157LL2N	280	40°	2	24	4000K	160LM	80
4157LS2H	1600		4157LL2H	280				3000K	160LM	80



ELECTRIFICATION

# LED

dettagli / details / details  
détalles / details:  
p.A54 - A55

Energy efficiency classes

Transformer available:

cod. 0409BT014 to connect up to **5** pieces – GE LIGHTING IP67 24V c.c. 12W  
cod. 0409BT015 to connect up to **10** pieces – GE LIGHTING IP67 24V c.c. 25W

Transformer on request:

cod. 0409BT016 to connect up to **42** pieces – GE LIGHTING IP67 24V c.c. 100W

A++ ÷ A

Accessories on request:



code **0404M009**  
Single connection IP68

mira 45 LT (24V)

Projectors

NEW

Recessed

Contemporary

Traditional



RECESSED

13



...brz



...inx



serie/series  
**wall  
 mira 45**

**LED**  
 powered by  
 Seoul® Semiconductor Z5M

example code:  
 | art. | LED |  | anodized |  
 4151 | L2 | H | inx

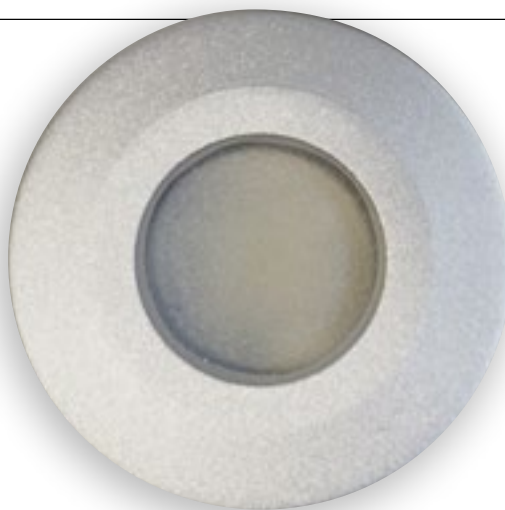

art.  
**4151**  
**4152**  
**4153**  
**4154**

design Ufficio Tecnico Landa



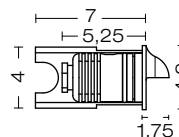
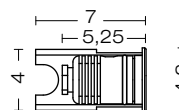
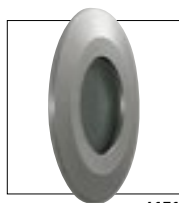
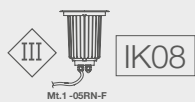

corpo alluminio estruso  
 anodizzato  
 body in extruded anodized  
 aluminium  
 corps en aluminium  
 extrudé anodisé  
 cuerpo en aluminio  
 extrusionado y anodizado  
 Körper aus eloxiertem  
 fließgepresst Aluminium

diffusore vetro opale  
 diffuser glass opal  
 diffuser verre opale  
 difusor vidrio ópalo  
 Diffuser Glas opal



FOR TECHNICAL DETAILS VISIT  
[www.landa.it](http://www.landa.it)

IP66

art.	art.		W	V	Type		Ra
4151L2N	4152L2N		2	24	4000K 160LM		80
4151L2H	4152L2H				3000K 160LM		80



ELECTRIFICATION



dettagli / details / details  
 detalles / details:  
 p.A54 - A55

Energy efficiency classes

Trasformer available:

cod. 0409BT014 to connect up to **5** pieces – GE LIGHTING IP67 24V c.c. 12W  
 cod. 0409BT015 to connect up to **10** pieces – GE LIGHTING IP67 24V c.c. 25W

Trasformer on request:

cod. 0409BT016 to connect up to **42** pieces – GE LIGHTING IP67 24V c.c. 100W

A++ ÷ A

wall  
mira 45 (24V)

Projectors

NEW

Recessed

Contemporary

Traditional

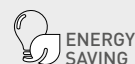

RECESSED

15

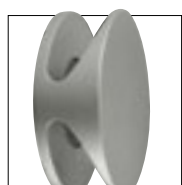

4153

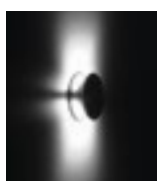

code ....L2

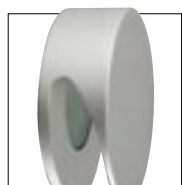
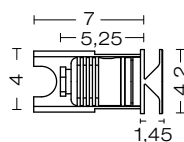

4154



code ....L2

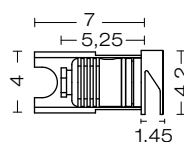

art.	art.		W	V	Type		Ra
4153L2N	4154L2N		2	24	4000K	160LM	80
4153L2H	4154L2H		2	24	3000K	160LM	80

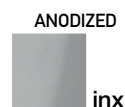

...brz



...inx

Accessories on request:



code 0404M009  
Single connection IP68



serie/series  
**wall  
 mira 65**

**LED**  
 powered by  
 Seoul® Semiconductor Z5M

example code:  
 | art. | LED | ○ | anodized |  
 4155 | L5 | N | brz

art.  
**4155**  
**4156**



design Ufficio Tecnico Landa

corpo alluminio estruso  
 anodizzato  
 body in extruded anodized  
 aluminium  
 corps en aluminium  
 extrudé anodisé  
 cuerpo en aluminio  
 extrusionado y anodizado  
 Körper aus eloxiertem  
 fließgepresst Aluminium

diffusore vetro opale  
 diffuser glass opal  
 diffuser verre opale  
 difusor vidrio ópalo  
 Diffuser Glas opal

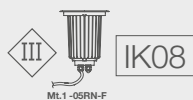

code ....L5

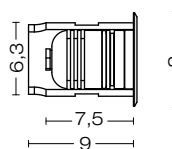

code ....L5

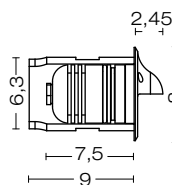

FOR TECHNICAL DETAILS VISIT  
[www.landa.it](http://www.landa.it)

IP66

art.	art.		W	V	Type		Ra
4155L5N	4156L5N		5	24	4000K	480LM	80
4155L5H	4156L5H				3000K	480LM	80



ELECTRIFICATION

**LED**

dettagli / details / details  
 detalles / details:  
 p.A54 - A55

Energy efficiency classes

Trasformer available:

cod. 0409BT014 to connect up to 2 pieces – GE LIGHTING IP67 24V c.c. 12W  
 cod. 0409BT015 to connect up to 4 pieces – GE LIGHTING IP67 24V c.c. 25W

Trasformer on request:

cod. 0409BT016 to connect up to 16 pieces – GE LIGHTING IP67 24V c.c. 100W

A++ ÷ A

Accessories on request:



code 0404M009  
 Single connection IP66

wall  
mira 65 (24V)

Projectors

NEW

Recessed

Contemporary

Traditional



RECESSED

17

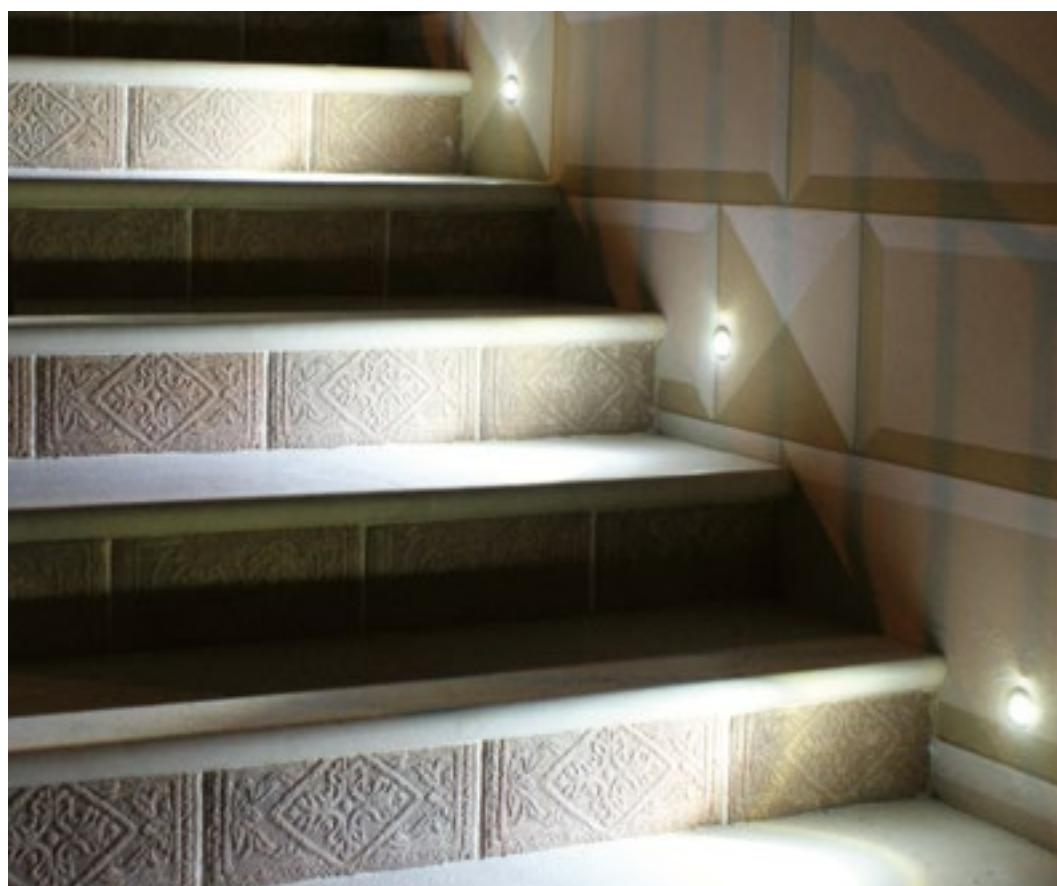

...brz





...inx





serie/series  
**wall  
mira 65**

**LED**  
powered by  
Philips Luxeon H50-2  
**AC direct connection**  
 220/240V  
Transformer not required

example code:  
| art. | LED |  | anodized |  
4158 L5 H brz

art.  
**4158**  
**4159**



design Ufficio Tecnico Landa

corpo alluminio estruso  
anodizzato  
body in extruded anodized  
aluminium  
corps en aluminium  
extrudé anodisé  
cuerpo en aluminio  
extrusionado y anodizado  
Körper aus eloxiertem  
fließgepresst Aluminium

diffusore vetro opale  
diffuser glass opal  
diffuser verre opale  
difusor vidrio ópalo  
Diffuser Glas opal



4158



code ....L5H

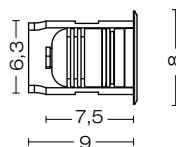

4159

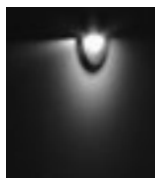

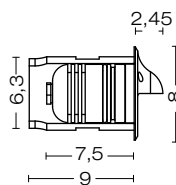

code ....L5H



FOR TECHNICAL DETAILS VISIT  
[www.landa.it](http://www.landa.it)

IP66

art.	art.		W	V	Type		Ra
4158L5H	4159L5H		5	220-240	3000K	400LM	80

ANODIZED  
 brz  
 inx

ELECTRIFICATION

**LED**

dettagli / details / details  
detalles / details:  
p.A54 - A55

Energy efficiency classes

A++ ÷ A

Accessories on request:



code 0404M009  
Single connection IP68

wall  
mira 65 (AC/240V)

Projectors

Recessed

Contemporary

Traditional



RECESSED

19

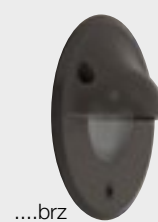

serie/series  
**round  
brick light**

  
simmetrico  
symmetric  
symétriques  
simétrico  
symmetrisch

°C  
temperatura sul vetro  
glass temperature  
température de verre  
temperatura del vidrio  
Glasterperatur

example code:  
| art. | electrification | colour |  
416 GU5.3 all

art.  
**416**  
**417**  
**418**



design Ufficio Tecnico Landa

corpo alluminio pressofuso  
body in die casting  
aluminium  
corps en aluminium moulé  
sous pression  
cuerpo aluminio inyectado  
Körper aus Aluminium-  
Druckguss

diffusore vetro opale  
diffuser glass opal  
diffuser verre opale  
difusor vidrio ópalo  
Diffuser Glas opal



416

frontale in alluminio /  
aluminium frame /  
cadre en aluminium /  
cornis aluminio / Rahmen  
aus Aluminium

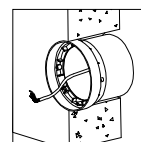
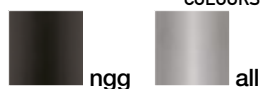

417





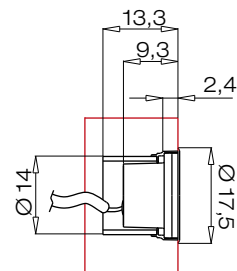

418

frontale in acciaio inox  
AISI 316L / stainless steel  
AISI 316L frame / cadre  
en acier inoxydable AISI  
316L / cornis acero inox  
AISI 316L / Rahmen aus  
Edelstahl AISI 316L





FOR TECHNICAL DETAILS VISIT  
[www.landa.it](http://www.landa.it)

IP66

art.	art.	art.	°C	W	V	Type	
416GU5.3	417GU5.3	418GU5.3	140	1x50	12	GU5,3	
416G9	417G9	418G9	125	1x60		G9	
416GU10	417GU10	418GU10	160	1x50		PAR 16/GU10	
416GX53	417GX53	418GX53	40	1x13		GX53	

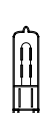
ELECTRIFICATION

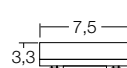
<p><b>GU5.3</b> 1 x max 50 W GU5,3</p>  <p>A ÷ F</p>	<p><b>G9</b> 1 x max 60 W G9</p>  <p>B ÷ F</p>	<p><b>GU10</b> 1 x max 50 W PAR 16/GU10</p>  <p>A ÷ F</p>	<p><b>GX53</b> 1 x max 13 W GX53</p>  <p>A ÷ B</p>
---	---	--	---

Energy efficiency classes

round brick light

Projectors

Recessed

Contemporary

Traditional



RECESSED



416M

frontale in alluminio /  
aluminium frame /  
cadre en aluminium /  
cornis aluminio / Rahmen  
aus Aluminium

COLOURS



ngg



all

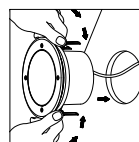

code: ...M

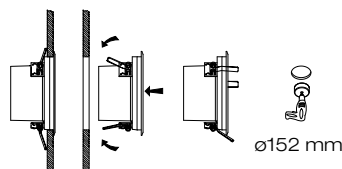

Ø152 mm

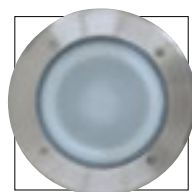

417M



418M

frontale in acciaio inox  
AISI 316L / stainless steel  
AISI 316L frame / cadre  
en acier inoxydable AISI  
316L / cornis acero inox  
AISI 316L / Rahmen aus  
Edelstahl AISI 316L

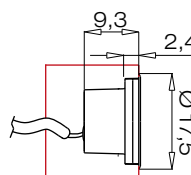

art.	art.	art.	°C	W	V	Type	
416GU5.3M	417GU5.3M	418GU5.3M	140	1x50	12	GU5,3	
416G9M	417G9M	418G9M	125	1x60		G9	
416GU10M	417GU10M	418GU10M	160	1x50		PAR 16/GU10	
416GX53M	417GX53M	418GX53M	40	1x13		GX53	

Accessories on request:

Antivandalism set



X 4

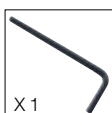

X 1

per/for/pour/  
para/für

00KAV02 0303CA3 code: 416...

Antivandalism set



X 4

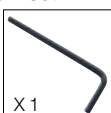

X 1

per/for/pour/  
para/für

code: 417...  
code: 418...

00KAV01 0303CA2.5



# brick light

# LED

powered by  
Citizen CLL130  
Transformer included



simmetrico  
symmetric  
symétriques  
simétrico  
symmetrisch

example code:

| art. | LED | colour |  
410 | L6 | H | ngg

| art. | electrification | colour |  
410 | E27 | ngg

art.  
410  
411  
412  
413

design Ufficio Tecnico Landa



RECESSED  
22

corpo alluminio pressofuso  
body in die casting aluminium  
corps en aluminium moulé  
sous pression  
cuerpo aluminio inyectado  
Körper aus Aluminium-  
Druckguss

diffusore vetro opale  
diffuser glass opal  
diffuser verre opale  
difusor vidrio ópalo  
Diffuser Glas opal



410

frontale in alluminio  
/ aluminium frame /  
cadre en aluminium  
cornis aluminio  
/ Rahmen aus  
Aluminium

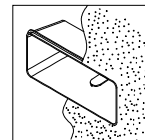
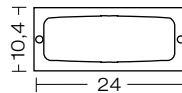

BOX DIMENSION

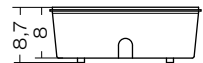
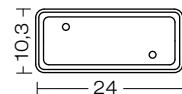

411

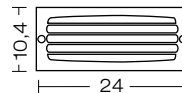

FOR TECHNICAL DETAILS VISIT  
[www.landa.it](http://www.landa.it)

IP54

art.	art.		W	V	Type		Ra
410L6	411L6		6	240	5000K 700LM	70	
410L6H	411L6H				3000K 600LM	80	
410	411		1x23		E27		



ELECTRIFICATION

# LED

dettagli / details / details  
detalles / details:  
p.A54 - A55

Energy efficiency classes



code ....L6  
A++ ÷ A

1x max 40 W



1x max 23 W

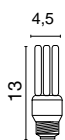

E27  
1x max 20 W

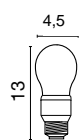

A ÷ E

# brick light



Thanks to Landlux - PT

Projectors

Recessed

Contemporary

Traditional



RECESSED



412

frontale in acciaio  
inox AISI 316L /  
stainless steel AISI  
316L frame / cadre  
en acier inoxydable  
AISI 316L / cornis  
acero inox AISI 316L  
/ Rahmen aus  
Edelstahl AISI 316L

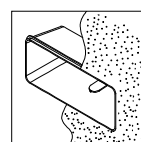
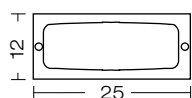

BOX DIMENSION

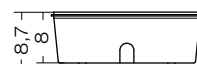
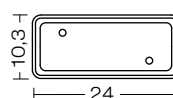

413

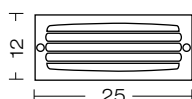

art.	art.		W	V	Type		Ra
412L6	413L6		6	240	5000K 700LM	70	
412L6H	413L6H				3000K 600LM	80	
412	413		1x23		E27		



# brick light

## LED

powered by  
Citizen CLL130  
Transformer included



simmetrico  
symmetric  
symétriques  
simétrico  
symmetrisch

example code:

art.	LED	○		colour
410	L6	H	M	ngg
art.	electrification			colour
410	E27		M	ngg

art.  
410...M  
411...M  
412...M  
413...M

design Ufficio Tecnico Landa



RECESSED  
24

corpo alluminio pressofuso  
body in die casting aluminium  
corps en aluminium moulé  
sous pression  
cuerpo aluminio inyectado  
Körper aus Aluminium-  
Druckguss

diffusore vetro opale  
diffuser glass opal  
diffuser verre opale  
difusor vidrio ópalo  
Diffuser Glas opal



410...M

frontale in alluminio  
/ aluminium frame /  
cadre en aluminium  
cornis aluminio  
/ Rahmen aus  
Aluminium

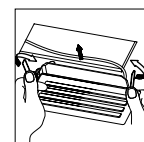
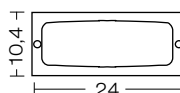

code: ...M

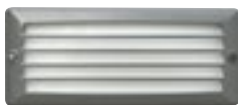

411...M

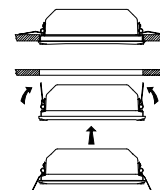
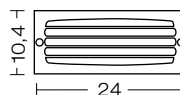

230x88 mm

FOR TECHNICAL DETAILS VISIT  
[www.landa.it](http://www.landa.it)

IP54

art.	art.	LED symbol	W	V	Type	Light bulb symbol	Ra
410L6M	411L6M	○	6	240	5000K 700LM	70	
410L6HM	411L6HM	○			3000K 600LM	80	
410M	411M		1x23		E27	Light bulb symbol	



ELECTRIFICATION

## LED

dettagli / details / details  
detalles / details:  
p.A54 - A55

Energy efficiency classes



code ...L6

A++ ÷ A

1x max 40 W



1x max 23 W

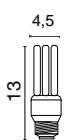

E27  
1x max 20 W

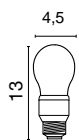

A+ ÷ E

brick light



Projectors

NEW

Recessed

Contemporary

Traditional



RECESSED

25



412...M



413...M

frontale in acciaio  
inox AISI 316L /  
stainless steel AISI  
316L frame / cadre  
en acier inoxydable  
AISI 316L / cornis  
acero inox AISI 316L  
/ Rahmen aus  
Edelstahl AISI 316L

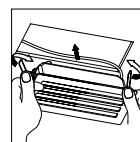
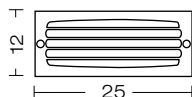
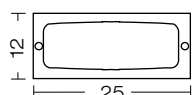

code: ...M

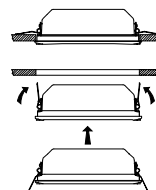

230x88 mm

art.	art.		W	V	Type		Ra
412L6M	413L6M		6	240	5000K 700LM	70	
412L6HM	413L6HM				3000K 600LM	80	
412M	413M		1x23		E27		





# brick light

# LED

powered by  
Citizen Electronics® LED  
Transformer included

asimmetrico  
asymmetric  
asymétriques  
asimétrico  
asymmetrisch

example code:  
| art. | LED | colour |  
414 L6 H nhg

art.  
**414**

design Ufficio Tecnico Landa



RECESSED  
26

corpo alluminio pressofuso  
body in die casting aluminium  
corps en aluminium moulé  
sous pression  
cuerpo aluminio inyectado  
Körper aus Aluminium-  
Druckguss

diffusore policarbonato opale  
diffuser opal polycarbonate  
diffuser polycarbonate opale  
difusor policarbonato ópalo  
Diffuser Polykarbonat opal

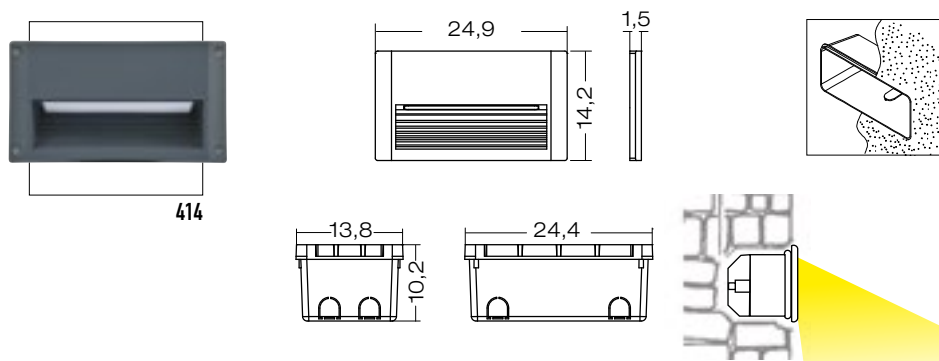

art.		W	V	Type	Light Bulb Icon
414F18		18	240	G24 q-2	
414F26		26	240	G24 q-3	
414L6		6	240	5000K	700LM
414L6H					
414L12		12	240	5000K	1520LM
414L12H					

FOR TECHNICAL DETAILS VISIT  
[www.landa.it](http://www.landa.it)

IP65

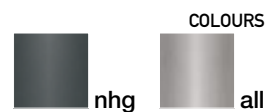

ELECTRIFICATION

# LED

dettagli / details / details  
detalles / details:  
p.A54 - A55

Energy efficiency classes



code ...L6  
... L12

A++ ÷ A

**F18**  
1 x 18 W  
G24 q-2

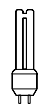

A+ ÷ B

**F26**  
1 x 26 W  
G24 q-3

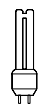

A+ ÷ B

# brick light



Thanks to Telesys - Tunisia

Projectors

Recessed

Contemporary

Traditional



RECESSED



# mira 45

**LED**  
powered by  
Seoul® Semiconductor Z5M

simmetrico  
symmetric  
symétriques  
simétrico  
symmetrisch

example code:  
| art. | LED |  | anodized |  
5441 L2 H inx

art.  
**5441**

design Ufficio Tecnico Landa



corpo alluminio estruso  
anodizzato  
body in extruded anodized  
aluminium  
corps en aluminium extrudé  
anodisé  
cuerpo en aluminio  
extrusionado y anodizado  
Körper aus eloxiertem  
fließgepresst Aluminium

diffusore vetro trasparente  
e opale  
diffuser glass transparent  
and opal  
diffuser verre transparent  
et opale  
difusor vidrio transparente  
y ópalo  
Diffuser Glas klar und opal

28 | RECESSED



5441

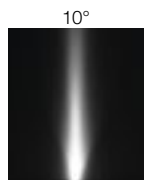

code ....LS2



5441

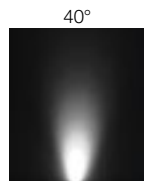

code ....LL2



5441

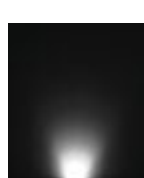

code ....L2

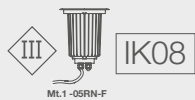
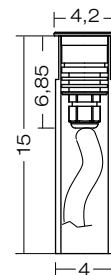

FOR TECHNICAL DETAILS VISIT  
[www.landa.it](http://www.landa.it)

IP67

art.	LUX 1mt	art.	LUX 1mt	art.	LUX 1mt	W	V	Type	Ⓛ	Ra
5441LS2N	1600	5441LL2N	280	5441L2N	40	2	24	4000K	160LM	80
5441LS2H	1600	5441LL2H	280	5441L2H	40			3000K	160LM	80

ELECTRIFICATION



dettagli / details / details  
détalles / details:  
p.A54 - A55

Energy efficiency classes

Trasformer available:

cod. 0409BT014 to connect up to **5** pieces – GE LIGHTING IP67 24V c.c. 12W  
cod. 0409BT015 to connect up to **10** pieces – GE LIGHTING IP67 24V c.c. 25W

Trasformer on request:

cod. 0409BT016 to connect up to **42** pieces – GE LIGHTING IP67 24V c.c. 100W

A++ ÷ A

Accessories on request:



code **0404M009**  
Single connection IP68

# mira 45 (24V)

Projectors

## NEW

Recessed

Contemporary

Traditional



RECESSED

29



Thanks to Ioannides Lighting LTD - CY



Thanks to Ioannides Lighting LTD - CY



...brz



...inx



# mira 45

# LED

powered by  
Seoul® Semiconductor Z5M

asimetrico  
asymmetric  
asymétriques  
asimétrico  
asymmetrisch

example code:

art.	LED	○	anodized
5442	L2	H	inx

art.  
**5442**  
**5443**  
**5444**

design Ufficio Tecnico Landa

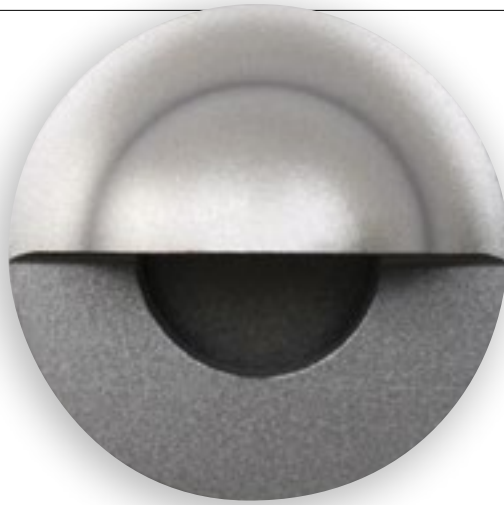

corpo alluminio estruso  
anodizzato  
body in extruded anodized  
aluminium  
corps en aluminium extrudé  
anodisé  
cuerpo en aluminio  
extrusionado y anodizado  
Körper aus eloxiertem  
fließgepresst Aluminium

diffusore vetro opale  
diffuser glass opal  
diffuser verre opale  
difusor vidrio ópalo  
Diffuser Glas opal

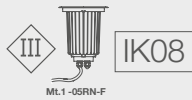

FOR TECHNICAL DETAILS VISIT  
[www.landa.it](http://www.landa.it)

IP67



5442

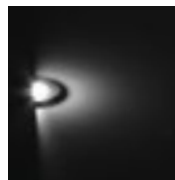

code ....L2

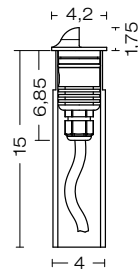

5443

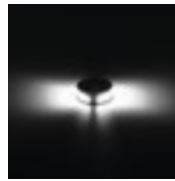

code ....L2

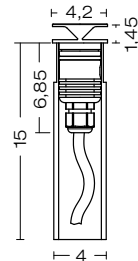

art.	art.	LED	W	V	Type	⚡	Ra
5442L2N	5443L2N	○	2	24	4000K 160LM	80	
5442L2H	5443L2H	○	2	24	3000K 160LM	80	

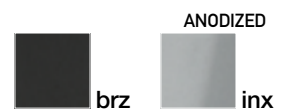

ELECTRIFICATION

# LED

dettagli / details / details  
détalles / details:  
p.A54 - A55

Energy efficiency classes

Transformer available:

cod. 0409BT014 to connect up to **5** pieces – GE LIGHTING IP67 24V c.c. 12W  
cod. 0409BT015 to connect up to **10** pieces – GE LIGHTING IP67 24V c.c. 25W

Transformer on request:

cod. 0409BT016 to connect up to **42** pieces – GE LIGHTING IP67 24V c.c. 100W

A++ ÷ A

mira 45 (24V)

Projectors  
**NEW**  
Recessed

Contemporary

Traditional

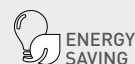

RECESSED

31



5444

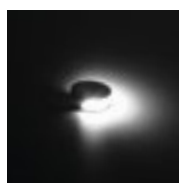

code ...L2

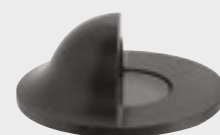
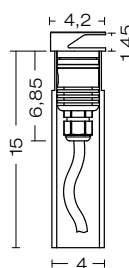

...brz



...inx

art.		W	V	Type		Ra
5444L2N		2	24	4000K 160LM		80
5444L2H		2	24	3000K 160LM		80

Accessories on request:



code 0404M009  
Single connection IP68



# mira 65

# LED

powered by  
Seoul® Semiconductor Z5M



simmetrico  
symmetric  
symétriques  
simétrico  
symmetrisch



asimmetrico  
asymmetric  
asymétriques  
asimétrico  
asymmetrisch

example code:

art.	LED	○	anodized
5321	LS5	N	inx

art.  
**5321**  
**5322**

design Ufficio Tecnico Landa

corpo alluminio estruso  
anodizzato  
body in extruded  
aluminium  
corps en aluminium extrudé  
anodisé  
cuerpo en aluminio  
extrusionado y anodizado  
Körper aus eloxiertem  
fließgepresst Aluminium

diffusore vetro trasparente  
e opale  
diffuser glass transparent  
and opal  
diffuser verre transparent  
et opale  
difusor vidrio transparente  
y ópalo  
Diffuser Glas klar und opal

32 RECESSED



5321

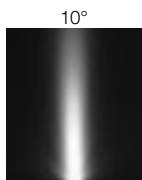

code ....LS5



5321



code ....LL5



5321



code ....L5

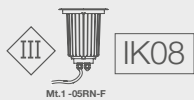
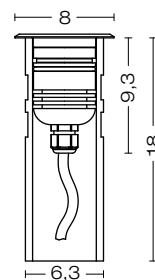

FOR TECHNICAL DETAILS VISIT  
[www.landa.it](http://www.landa.it)

IP67

art.	LUX 1mt	art.	LUX 1mt	art.	LUX 1mt	W	V	Type	Ⓛ	Ra
5321LS5N3740	10°	5321LL5N	700	5321L5N	124	5	24	4000K	480LM	80
5321LS5H3740		5321LL5H	700	5321L5H	124			3000K	480LM	80

ELECTRIFICATION

# LED

dettagli / details / details  
detales / details:  
p.A54 - A55

Energy efficiency classes

Trasformer available:

cod. 0409BT014 to connect up to **2** pieces – GE LIGHTING IP67 24V c.c. 12W  
cod. 0409BT015 to connect up to **4** pieces – GE LIGHTING IP67 24V c.c. 25W

Trasformer on request:

cod. 0409BT016 to connect up to **16** pieces – GE LIGHTING IP67 24V c.c. 100W

A++ ÷ A

mira 65 (24V)

Projectors  
**NEW**  
Recessed

Contemporary

Traditional

Thanks to MP Illumination - GR



RECESSED

33



5322



code ....L5

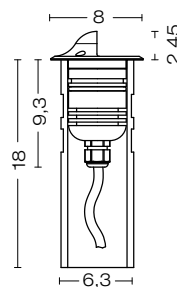

...brz



...inx

art.		W	V	Type		Ra
5322L5N		5	24	4000K 480LM		80
5322L5H		5	24	3000K 480LM		80



Accessories on request:



code 0404M009  
Single connection IP68







serie/series

# mira 65

# LED

powered by  
**Philips Luxeon H50-2**  
**AC direct connection**  
220/240V  
**Transformer not required**

	
simmetrico	asimmetrico
symmetric	asymmetric
symétriques	asymétriques
simétrico	asimétrico
symmetrisch	asymmetrisch

example code:  

art.	LED	anodized
5351	LS5	H inx

art.  
**5351**  
**5352**

design **Ufficio Tecnico Landa**

corpo alluminio estruso  
anodizzato  
body in extruded  
aluminium  
corps en aluminium extrudé  
anodisé  
cuerpo en aluminio  
extrusionado y anodizado  
Körper aus eloxiertem  
fließgepresst Aluminium

diffusore vetro trasparente  
e opale  
diffuser glass transparent  
and opal  
diffuser verre transparent  
et opale  
difusor vidrio transparente  
y ópalo  
Diffuser Glas klar und opal

34 | RECESSED



5351



code ....LS5



5351



code ....LL5



5351



code ....L5

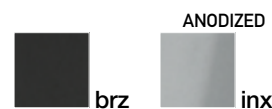
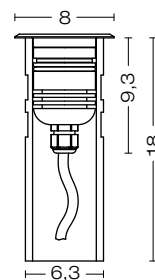

FOR TECHNICAL DETAILS VISIT  
[www.landa.it](http://www.landa.it)

IP67

art.	LUX 1mt	art.	LUX 1mt	art.	LUX 1mt	W	V	Type	Ra
5351LS5H	2070 15°	5351LL5H	525 30°	5351L5H	92	5	240	3000K 400LM	80

ELECTRIFICATION

# LED

dettagli / details / details  
detalles / details:  
p.A54 - A55

Energy efficiency classes

A++ ÷ A

mira 65 (AC/240V)

Project by: Martin Fukna OMS - SK



Projectors

Recessed

Contemporary

Traditional



RECESSED

35



5352



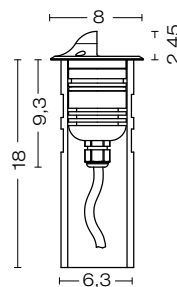

code ....L5



...brz



...inx

art.		W	V	Type		Ra
5352L5H		5	240	3000K	400LM	80



Accessories on request:



code 0404M009  
Single connection IP68



# mira 150

**LED** 12W  
 powered by  
**Seoul® Semiconductor Z5M**  
 Transformer included

  
 simmetrici aggiustabili  
 Adjustable reflectors  
 symétriques ajustables  
 Reflectores ajustables  
 symmetrisch und regelbar

°C  
 temperatura sul vetro  
 glass temperature  
 température de verre  
 temperatura del vidrio  
 Glastemperatur

example code:  
 art. **LED 10°**  colour  
 5111 LS9 H ngg

art.  
**5111**  
**5121**  
**5131**  
**5141**

design Ufficio Tecnico Landa



36 | RECESSED

corpo alluminio pressofuso  
 body in die casting aluminium  
 corps en aluminium moulé  
 sous pression  
 cuerpo aluminio inyectado  
 Körper aus Aluminium-  
 Druckguss

diffusore vetro trasparente  
 diffuser glass transparent  
 diffuser verre transparent  
 difusor vidrio transparente  
 Diffuser Glas klar

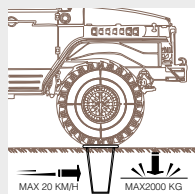

CL.I  IK10  
 ML2 H07RN-F



5111

frontale in alluminio / aluminium frame /  
 cadre en aluminium / cornis aluminio /  
 Rahmen aus Aluminium

COLOURS  
 ngg  all

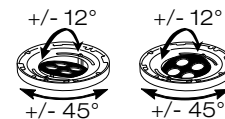

5121







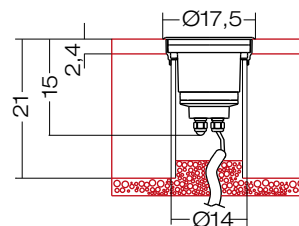





5141

frontale in acciaio inox  
 AISI 316L / stainless  
 steel AISI 316L frame  
 / cadre en acier  
 inoxydable AISI 316L /  
 cornis acero inox AISI  
 316L / Rahmen aus  
 Edelstahl AISI 316L



FOR TECHNICAL DETAILS VISIT  
[www.landa.it](http://www.landa.it)

IP67

art.	art.	art.		°C	W	V	Type		LUX 1Mt	Ra
5111LS9N	5121LS9N	5141LS9N		35	12	240	4000K	840LM	10700	80
5111LS9H	5121LS9H	5141LS9H		3000K	840LM	10700	80			
 5111LM9N	5121LM9N	5141LM9N		35	12	240	4000K	840LM	2400	80
 5111LM9H	5121LM9H	5141LM9H		3000K	840LM	2400	80			
5111LL9N	5121LL9N	5141LL9N		35	12	240	4000K	840LM	720	80
5111LL9H	5121LL9H	5141LL9H		3000K	840LM	720	80			

ELECTRIFICATION

**LED**

dettagli / details / details  
 detalles / details:  
 p.A54 - A55

Energy efficiency classes

12W Transformer included

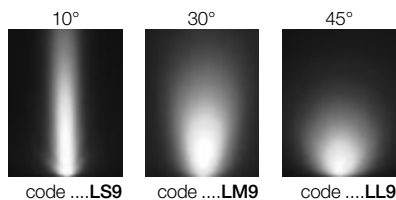

code ....LS9      code ....LM9      code ....LL9

A++ ÷ A

mira 150 (12W)

Projectors  
**NEW**  
Recessed

Contemporary

Traditional



RECESSED



Lighting design : Apostolis Kouikoglou  
Photo : Chatzizanos  
Place : Nirides Hotel Methoni Greece



5131

frontale in acciaio inox  
AISI 316L / stainless  
steel AISI 316L frame  
/ cadre en acier  
inoxydable AISI 316L /  
cornis acero inox AISI  
316L / Rahmen aus  
Edelstahl AISI 316L



filo pavimento  
flush  
à niveau du sol  
a ras de suelo  
Bodeneinbau

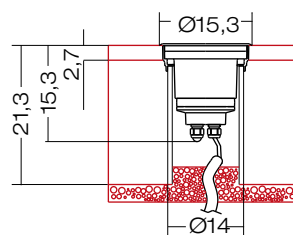
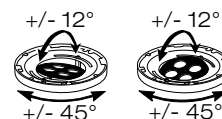

art.		°C	W	V	Type		LUX 1Mt	Ra	
5131LS9N		10°	35	12	240	4000K	840LM	10700	80
5131LS9H		10°	35	12	240	3000K	840LM	10700	80
5131LM9N		30°	35	12	240	4000K	840LM	2400	80
5131LM9H		30°	35	12	240	3000K	840LM	2400	80
5131LL9N		45°	35	12	240	4000K	840LM	720	80
5131LL9H		45°	35	12	240	3000K	840LM	720	80

Also available with:



cod. 0201007B  
vetro opale/opal glass/  
verre opale/vidrio ópalo/  
Glas opal

Accessories on request:

Antivandalism set



00KAV02 X4 0303CA3 X1 per/for/pour/  
para/für code: 5111...

Antivandalism set



00KAV01 X4 0303CA2.5 X1 per/for/pour/  
para/für code: 5121...  
code: 5131...  
code: 5141...



serie/series

# mira 220

# LED

powered by  
Citizen Electronics® LED  
AC direct connection  
220/240V  
Transformer not required



simmetrici aggiustabili  
Adjustable reflectors  
symétriques ajustables  
Reflectores ajustables  
symmetrisch und regelbar

°C

temperatura sul vetro  
glass temperature  
température de verre  
temperatura del vidrio  
Glastemperatur

example code:

art. LED 60° colour  
5512 LL20 H all

art.  
5512  
5522  
5532  
5542

design Ufficio Tecnico Landa

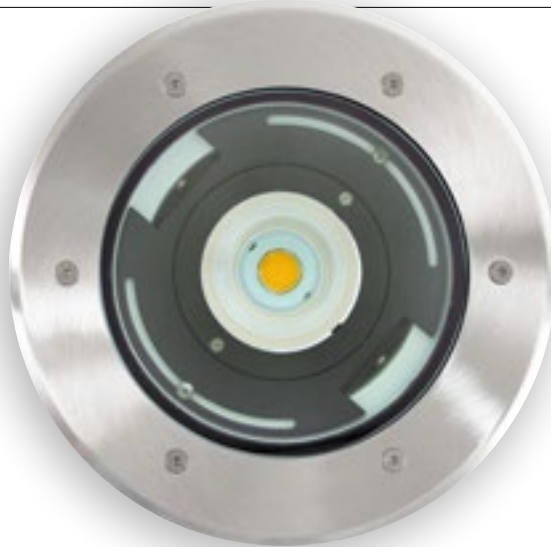

38 RECESSED

corpo alluminio pressofuso

body in die casting aluminium  
corps en aluminium moulé  
sous pression  
cuerpo aluminio inyectado  
Körper aus Aluminium-  
Druckguss

diffusore vetro trasparente

diffuser glass transparent  
diffuser verre transparent  
difusor vidrio transparente  
Diffuser Glas klar

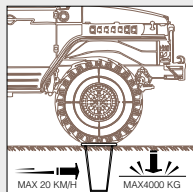

CL.I

IK10

ML2 H07RN-F



5512

frontale in alluminio / aluminium frame /  
cadre en aluminium / cornis aluminio /  
Rahmen aus Aluminium

COLOURS



ngg



all



5522



5542

frontale in acciaio inox  
AISI 316L / stainless  
steel AISI 316L frame  
/ cadre en acier  
inoxydable AISI 316L /  
cornis acero inox AISI  
316L / Rahmen aus  
Edelstahl AISI 316L

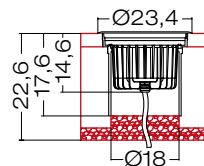

FOR TECHNICAL DETAILS VISIT  
[www.landa.it](http://www.landa.it)

IP67

art.	art.	art.	°C	W	V	Type	LUX 1Mt
5512LS20N	5522LS20N	5542LS20N	20°	29	20	4000K 2385LM	5900
5512LS20H	5522LS20H	5542LS20H	20°	29	20	3000K 2280LM	5600
5512LL20N	5522LL20N	5542LL20N	60°	29	20	4000K 2385LM	1380
5512LL20H	5522LL20H	5542LL20H	60°	29	20	3000K 2280LM	1300

ELECTRIFICATION

# LED

dettagli / details / details  
détalles / details:  
p.A54 - A55

Energy efficiency classes

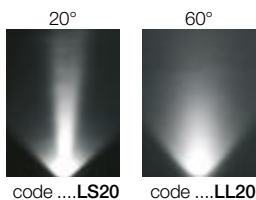

code ....LS20

code ....LL20

A++ ÷ A

Also available with:

cod. 0201001.19B  
vetro opale/opal glass/  
verre opale/vidrio ópalo/Glas opal



cod. 0201001.19A  
vetro antiscivolo/non-slip glass/  
verre anti dérapant/cristal antiresbaladizo/  
rutschhemmendes Glas



mira 220

Projectors  
**NEW**  
Recessed

Contemporary

Traditional



RECESSED

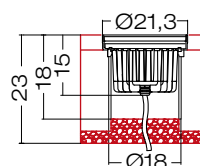
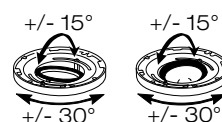

5532

frontale in acciaio inox  
AISI 316L / stainless  
steel AISI 316L frame  
/ cadre en acier  
inoxydable AISI 316L /  
cornis acero inox AISI  
316L / Rahmen aus  
Edelstahl AISI 316L



filo pavimento  
flush  
à niveau du sol  
a ras de suelo  
Bodeneinbau

art.		°C	W	V	Type		LUX 1Mt
5532LS20N		29	20	220-240	4000K 2385LM		5900
5532LS20H		29	20	220-240	3000K 2280LM		5600
5532LL20N		29	20	220-240	4000K 2385LM		1380
5532LL20H		29	20	220-240	3000K 2280LM		1300

Accessories on request:

Antivandalism set



X6  
00KAV03

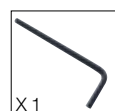

X1  
0303CA3

per/for/pour/  
para/für

code: 5512...

Antivandalism set



X6  
00KAV04

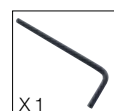

X1  
0303CA3

per/for/pour/  
para/für

code: 5522...

code: 5532...

code: 5542...



serie/series

# mira 220

# LED

powered by  
Citizen Electronics® LED  
AC direct connection  
220/240V  
Transformer not required

simmetrico  
symmetric  
symétriques  
simétrico  
symmetrisch

°C  
temperatura sul vetro  
glass temperature  
température de verre  
temperatura del vidrio  
Glastemperatur

example code:  
art. LED 50° colour  
5511 LL20 H ngg

art.  
5511  
5521  
5531  
5541

design Ufficio Tecnico Landa



40 RECESSED

corpo alluminio pressofuso  
body in die casting aluminium  
corps en aluminium moulé  
sous pression  
cuerpo aluminio inyectado  
Körper aus Aluminium-  
Druckguss

diffusore vetro trasparente  
diffuser glass transparent  
diffuser verre transparent  
difusor vidrio transparente  
Diffuser Glas klar

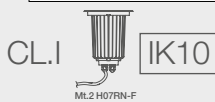
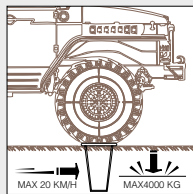

5511

frontale in alluminio / aluminium frame /  
cadre en aluminium / cornis aluminio /  
Rahmen aus Aluminium

COLOURS

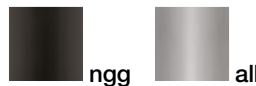

5521



5541

frontale in acciaio inox  
AISI 316L / stainless  
steel AISI 316L frame  
/ cadre en acier  
inoxydable AISI 316L /  
cornis acero inox AISI  
316L / Rahmen aus  
Edelstahl AISI 316L

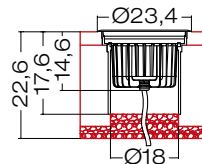

FOR TECHNICAL DETAILS VISIT  
[www.landa.it](http://www.landa.it)

IP67

art.	art.	art.	°C	W	V	Type	LUX 1Mt
5511LS20N	5521LS20N	5541LS20N	15°	29	20	220-240	4000K 2385LM 12200
5511LS20H	5521LS20H	5541LS20H	15°	35	33	220-240	3000K 2280LM 11600
5511LL20N	5521LL20N	5541LL20N	50°	29	20	220-240	4000K 2385LM 2200
5511LL20H	5521LL20H	5541LL20H	50°	35	33	220-240	3000K 2280LM 2100
5511LS30N	5521LS30N	5541LS30N	15°	35	33	220-240	4000K 3515LM 19700
5511LS30H	5521LS30H	5541LS30H	15°	35	33	220-240	3000K 3300LM 18700
5511LL30N	5521LL30N	5541LL30N	50°	35	33	220-240	4000K 3515LM 3050
5511LL30H	5521LL30H	5541LL30H	50°	35	33	220-240	3000K 3300LM 2900

ELECTRIFICATION

# LED

dettagli / details / details  
détalles / details:  
p.A54 - A55

Energy efficiency classes

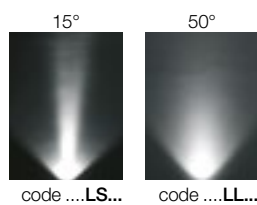

A++ ÷ A

Also available with:

cod. 0201001.19B  
vetro opale/opal glass/  
verre opale/vidrio ópalo/Glas opal



cod. 0201001.19A  
vetro antiscivolo/non-slip glass/  
verre anti dérapant/cristal antiresbaladizo/  
rutschhemmendes Glas



mira 220

Projectors  
**NEW**  
Recessed

Contemporary

Traditional



RECESSED

41

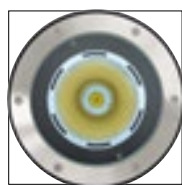

5531

frontale in acciaio inox  
AISI 316L / stainless  
steel AISI 316L frame  
/ cadre en acier  
inoxydable AISI 316L /  
cornis acero inox AISI  
316L / Rahmen aus  
Edelstahl AISI 316L



filo pavimento  
flush  
à niveau du sol  
a ras de suelo  
Bodeneinbau

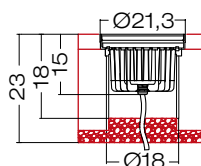

art.		°C	W	V	Type		LUX 1Mt
5531LS20N					4000K 2385LM	12200	
5531LS20H		15°	29	20	220-240	3000K 2280LM	11600
5531LL20N					4000K 2385LM	2200	
5531LL20H		50°	29	20	220-240	3000K 2280LM	2100
5531LS30N					4000K 3515LM	19700	
5531LS30H		15°	35	33	220-240	3000K 3300LM	18700
5531LL30N					4000K 3515LM	3050	
5531LL30H		50°	35	33	220-240	3000K 3300LM	2900

Accessories on request:

Antivandalism set



X6  
00KAV03

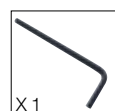

X1  
0303CA3

per/for/pour/  
para/für

code: 5511...

Antivandalism set



X6  
00KAV04

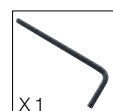

X1  
0303CA3

per/for/pour/  
para/für

code: 5521...

code: 5531...

code: 5541...





serie/series

# ASYMMETRIC mira 200

 asimmetrici regolabili  
Adjustable reflectors  
asymétriques ajustables  
Reflectores ajustables  
asymmetrisch und regelbar

°C temperatura sul vetro  
glass temperature  
température de verre  
temperatura del vidrio  
Glasterperatur

example code:  
| art. | electrification | colour |  
5011 H35AS all

art.  
5011  
5021  
5031  
5041

design Ufficio Tecnico Landa



42 RECESSED

corpo alluminio pressofuso  
body in die casting aluminium  
corps en aluminium moulé  
sous pression  
cuerpo aluminio inyectado  
Körper aus Aluminium-  
Druckguss

diffusore vetro trasparente  
diffuser glass transparent  
diffuser verre transparent  
difusor vidrio transparente  
Diffuser Glas klar

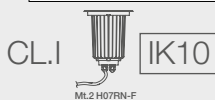
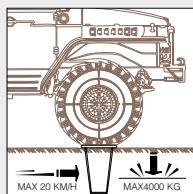

5011

frontale in alluminio / aluminium frame /  
cadre en aluminium / cornis aluminium /  
Rahmen aus Aluminium

COLOURS



5021





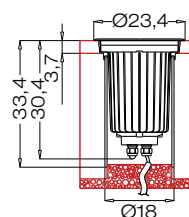

5041

frontale in acciaio inox  
AISI 316L / stainless  
steel AISI 316L frame  
/ cadre en acier  
inoxydable AISI 316L /  
cornis acero inox AISI  
316L / Rahmen aus  
Edelstahl AISI 316L



FOR TECHNICAL DETAILS VISIT  
[www.landa.it](http://www.landa.it)

IP67

art.	art.	art.		°C	W	Type	
 5011H35AS	5021H35AS	5041H35AS	22°	88	1x35	HIT / G8,5	
5011H70AS	5021H70AS	5041H70AS		120	1x70		

ELECTRIFICATION

**H35AS**  
35 W  
G8,5



A+ ÷ C

**H70AS**  
70 W  
G8,5



A+ ÷ C

Energy efficiency classes

Also available with:

cod. 0201001.19B  
vetro opale/opal glass/  
verre opale/vidrio ópalo/Glas opal



cod. 0201001.19A  
vetro antiscivolo/non-slip glass/  
verre anti dérapant/cristal antiresbaladizo/  
rutschhemmendes Glas



Projectors

Recessed

Contemporary

Traditional

Thanks to Ellabo - HR



RECESSED



5031

frontale in acciaio inox  
AISI 316L / stainless  
steel AISI 316L frame  
/ cadre en acier  
inoxydable AISI 316L /  
cornis acero inox AISI  
316L / Rahmen aus  
Edelstahl AISI 316L



filo pavimento  
flush  
à niveau du sol  
a ras de suelo  
Bodeneinbau

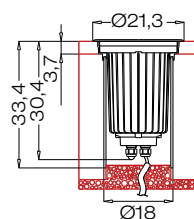

art.		°C	W	Type
5031H35AS	22°	88	1x35	HIT / G8,5
5031H70AS		120	1x70	

Accessories on request:

Antivandalism set



X6  
00KAV03

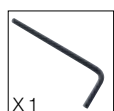

X1  
0303CA3

per/for/pour/  
para/für

code: 5011...

Antivandalism set



X6  
00KAV04

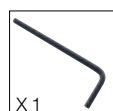

X1  
0303CA3

per/for/pour/  
para/für

code: 5021...

code: 5031...

code: 5041...



serie/series

# ADJUSTABLE mira 200

 simmetrici aggiustabili  
Adjustable reflectors  
symétriques ajustables  
Reflectores ajustables  
symmetrisch und regelbar

°C  
temperatura sul vetro  
glass temperature  
température de verre  
temperatura del vidrio  
Glasterperatur

example code:  
| art. | electrification | colour |  
5013 H35AS all

art.  
5013  
5023  
5033  
5043

design Ufficio Tecnico Landa



RECESSED  
44

corpo alluminio pressofuso  
body in die casting aluminium  
corps en aluminium moulé  
sous pression  
cuerpo aluminio inyectado  
Körper aus Aluminium-  
Druckguss

diffusore vetro trasparente  
diffuser glass transparent  
diffuser verre transparent  
difusor vidrio transparente  
Diffuser Glas klar

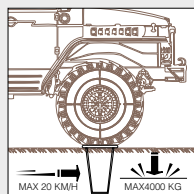

CL.I IK10  
ML2 H07RN-F



5013

frontale in alluminio / aluminium frame /  
cadre en aluminium / cornis aluminium /  
Rahmen aus Aluminium

COLOURS



5023





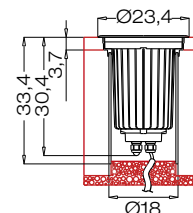
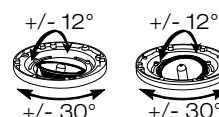

5043

frontale in acciaio inox  
AISI 316L / stainless  
steel AISI 316L frame  
/ cadre en acier  
inoxydable AISI 316L /  
cornis acero inox AISI  
316L / Rahmen aus  
Edelstahl AISI 316L





FOR TECHNICAL DETAILS VISIT  
[www.landa.it](http://www.landa.it)

IP67

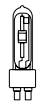

art.	art.	art.			°C	W	Type	
5013H35	5023H35	5043H35	-32°/+32°	15°	94	1x35	HIT / G12	
5013H70	5023H70	5043H70			132	1x70		
5013H35S	5023H35S	5043H35S	-4°/+4°	15°	94	1x35	HIT / G12	
5013H70S	5023H70S	5043H70S			132	1x70		

ELECTRIFICATION

**H35**  
**H35S**  
1 x 35 W  
HIT/G12  
  
A+ ÷ C

**H70**  
**H70S**  
1 x 70 W  
HIT/G12  
  
A+ ÷ C

Energy efficiency classes

Also available with:  
cod. 0201001.19B  
vetro opale/opal glass/  
verre opale/vidrio ópalo/Glas opal   
cod. 0201001.19A  
vetro antiscivolo/non-slip glass/  
verre anti dérapant/cristal antiresbaladizo/  
rutschhemmendes Glas 

ADJUSTABLE  
**mira 200**

Projectors

Recessed

Contemporary

Traditional

RECESSED

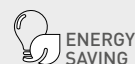

Thanks to: Aric - FR



5033

frontale in acciaio inox  
AISI 316L / stainless  
steel AISI 316L frame  
/ cadre en acier  
inoxydable AISI 316L /  
cornis acero inox AISI  
316L / Rahmen aus  
Edelstahl AISI 316L



filo pavimento  
flush  
à niveau du sol  
a ras de suelo  
Bodeneinbau

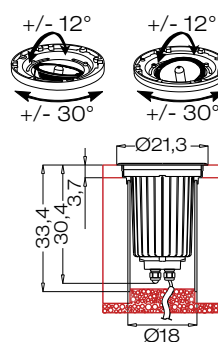

art.		°C	W	Type	
5033H35	-32°/+32°	15°	94	1x35	
5033H70			132	1x70	HIT / G12
5033H35S	-4°/+4°	15°	94	1x35	
5033H70S			132	1x70	



Accessories on request:

**Antivandalism set**



X6  
00KAV03

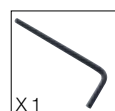

X1  
0303CA3

per/for/pour/  
para/für

code: 5013...

**Antivandalism set**



X6  
00KAV04

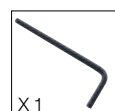

X1  
0303CA3

per/for/pour/  
para/für

code: 5023...

code: 5033...

code: 5043...



serie/series

COOL TOUCH  
mira 200

  
simmetrico  
symmetric  
symétriques  
simétrico  
symmetrisch

  
asimmetrici aggiustabili  
Adjustable reflectors  
Asymétriques ajustables  
Reflectores ajustables  
asymmetrisch und regelbar

°C  
temperatura sul vetro  
glass temperature  
température de verre  
temperatura del vidrio  
Glasterperatur

example code:  
art. | electrification | colour |  
5012 | H35 | all

art.  
5012  
5022  
5032  
5042

design Ufficio Tecnico Landa

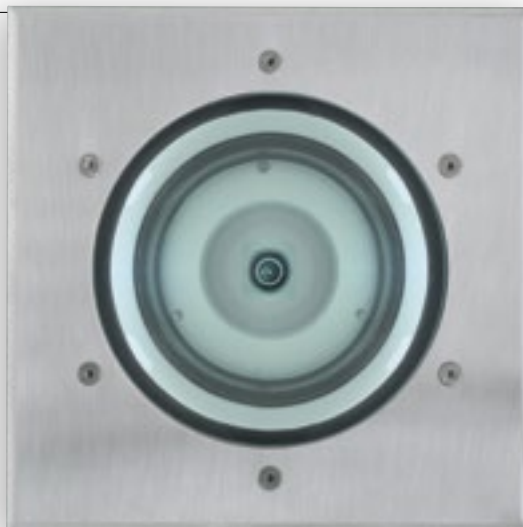

RECESSED  
46

corpo alluminio pressofuso  
body in die casting aluminium  
corps en aluminium moulé  
sous pression  
cuerpo aluminio inyectado  
Körper aus Aluminium-  
Druckguss

diffusore vetro trasparente  
diffuser glass transparent  
diffuser verre transparent  
difusor vidrio transparente  
Diffuser Glas klar

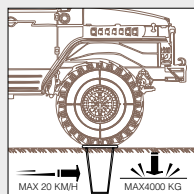

CL.I IK10  
ML2 H07RN-F



5012

frontale in alluminio / aluminium frame /  
cadre en aluminium / cornis aluminio /  
Rahmen aus Aluminium

COLOURS



5022

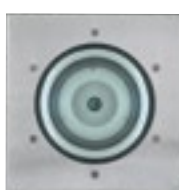

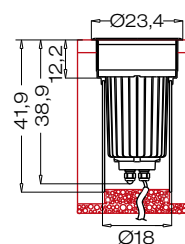

5042

frontale in acciaio inox  
AISI 316L / stainless  
steel AISI 316L frame  
/ cadre en acier  
inoxydable AISI 316L /  
cornis acero inox AISI  
316L / Rahmen aus  
Edelstahl AISI 316L



FOR TECHNICAL DETAILS VISIT  
[www.landa.it](http://www.landa.it)

IP67

art.	art.	art.		°C	W	Type	
5012H35	5022H35	5042H35	-32°/+32°	59	1x35	HIT / G12	
5012H70	5022H70	5042H70		79	1x70		
5012H35S	5022H35S	5042H35S		-4°/+4°	59		
5012H70S	5022H70S	5042H70S	79		1x70		

ELECTRIFICATION

**H35**  
**H35S**  
1x35W  
HIT/G12



A+ ÷ C

**H70**  
**H70S**  
1x70W  
HIT/G12



A+ ÷ C

Energy efficiency classes

Also available with:

cod. **0201001.19B**  
vetro opale/opal glass/  
verre opale/vidrio ópalo/Glas opal



cod. **0201001.19A**  
vetro antiscivolo/non-slip glass/  
verre anti dérapant/cristal antiresbaladizo/  
rutschhemmendes Glas





Projectors

Recessed

Contemporary

Traditional

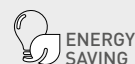

RECESSED

47



5032

frontale in acciaio inox  
AISI 316L / stainless  
steel AISI 316L frame  
/ cadre en acier  
inoxydable AISI 316L /  
cornis acero inox AISI  
316L / Rahmen aus  
Edelstahl AISI 316L



filo pavimento  
flush  
à niveau du sol  
a ras de suelo  
Bodeneinbau

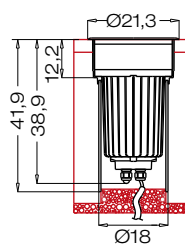

art.		°C	W	Type	
5032H35		59	1x35		
5032H70	-32°/+32°	79	1x70		
5032H35S		59	1x35	HIT / G12	
5032H70S	-4°/+4°	79	1x70		

Accessories on request:

Optional:



15°

cod. 0201006  
vetro asimmetrico/asymmetric  
glass/verre asymétrique/  
vidrio asimétrico/  
asymmetrisches Glas

Antivandalism set



X6  
00KAV03

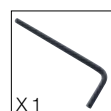

X1  
0303CA3

per/for/pour/  
para/für

code: 5012...

Antivandalism set



X6  
00KAV04

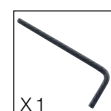

X1  
0303CA3

per/for/pour/  
para/für

code: 5022...

code: 5032...

code: 5042...



serie/series

# mira 220

# LED

powered by  
Citizen Electronics® LED  
AC direct connection  
220/240V  
Transformer not required

example code:  
art. LED colour  
5051 L20 H ngg

art.  
**5051**  
**5061**



design Ufficio Tecnico Landa

corpo alluminio pressofuso  
body in die casting aluminium  
corps en aluminium moulé  
sous pression  
cuerpo aluminio inyectado  
Körper aus Aluminium-  
Druckguss

diffusore vetro opale  
diffuser glass opal  
diffuser verre opale  
difusor vidrio ópalo  
Diffuser Glas opal

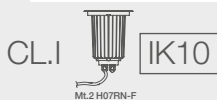
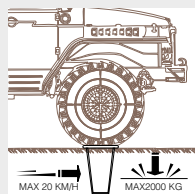

5051



5061

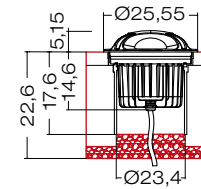
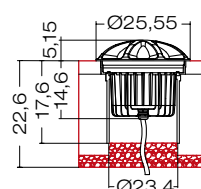

FOR TECHNICAL DETAILS VISIT  
[www.landa.it](http://www.landa.it)

IP67

art.	art.	W	V	Type	💡
5051L20N	5061L20N	○	1x20 220-240	4000K 2385LM	
5051L20H	5061L20H	●		3000K 2280LM	
5051L30N	5061L30N	○	1x33 220-240	4000K 3515LM	
5051L30H	5061L30H	●		3000K 3300LM	

COLOURS  
ngg all

ELECTRIFICATION

# LED

dettagli / details / details  
detalles / details:  
p.A54 - A55

Energy efficiency classes

A++ ÷ A

# mira 220

Projectors

## NEW

Recessed

Contemporary

Traditional



ENERGY  
SAVING

RECESSED

49

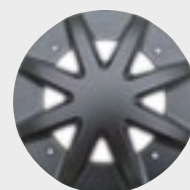

Thanks to Credo Trading - Qatar





# tubo

**LED**  
powered by  
Liteon® Optoelectronics

simmetrico  
symmetric  
symétriques  
simétrico  
symmetrisch





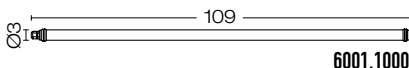
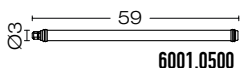

example code:  
| art. | size | LED |  |  
6001 .0500 L10 H

art.  
**6001**  
**6002**

design Ufficio Tecnico Landa



single connection  
2 Mt. cable  
-05RN-F  
included

art.		°C	W	V	Type		Ra
6001.0500L10N		150°	25	10	24 c.c.	4000K 1200LM	80
6001.0500L10H						3000K 1050LM	80
6001.1000L20N		150°	25	20	24 c.c.	4000K 2400LM	80
6001.1000L20H						3000K 2100LM	80

CONTEMPORARY

50

corpo alluminio estruso  
anodizzato e policarbonato  
trasparente

body in extruded anodized  
aluminium and transparent  
polycarbonate

corps en aluminium extrudé  
anodisé et polycarbonate  
transparent

cuerpo en aluminio  
extrusionado y anodizado y  
policarbonato transparente





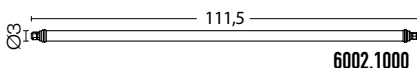
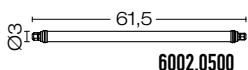

Körper aus eloxiertem  
fließgepresst Aluminium und  
Polykarbonat klar

diffusore policarbonato opale  
diffuser opal polycarbonate  
diffuser polycarbonate opale  
difusor policarbonato ópalo  
Diffuser Polykarbonat opal

 24V c.c.



loop in loop out connection  
2x2 Mt. cable  
-05RN-F  
included

art.		°C	W	V	Type		Ra
6002.0500L10N		150°	25	10	24 c.c.	4000K 1200LM	80
6002.0500L10H						3000K 1050LM	80
6002.1000L20N		150°	25	20	24 c.c.	4000K 2400LM	80
6002.1000L20H						3000K 2100LM	80

FOR TECHNICAL DETAILS VISIT  
[www.landa.it](http://www.landa.it)

IP67

ELECTRIFICATION

**LED**

dettagli / details / details  
détalles / details:  
p.A52-A53

Energy efficiency classes

Trasformer available:

cod. 0409BT014 – GE LIGHTING IP67 24V c.c. 12W  
cod. 0409BT015 – GE LIGHTING IP67 24V c.c. 25W

Trasformer on request:

cod. 0409BT016 – GE LIGHTING IP67 24V c.c. 100W

A++ ÷ A

Accessories on request:



code **0404M011**  
Single connection IP68

tubo

Projectors

Recessed

NEW

Contemporary

Traditional

CONTEMPORARY



Accessories:



00A6001.01



00A6001.02

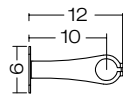

00A6001.03

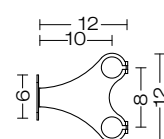

00A6001.04

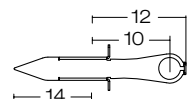

00A6001.05



# tubo

**LED**  
powered by  
Liteon® Optoelectronics

simmetrico  
symmetric  
symétriques  
simétrico  
symmetrisch

example code:  
| art. | size | LED | ○ |  
6011 .1000 L20 N

art.  
**6011**  
**6012**

design Ufficio Tecnico Landa

corpo alluminio estruso  
anodizzato e policarbonato  
trasparente

body in extruded anodized  
aluminium and transparent  
polycarbonate

corps en aluminium extrudé  
anodisé et polycarbonate  
transparent

cuerpo en aluminio  
extrusionado y anodizado y  
policarbonato transparente

52

Körper aus eloxiertem  
fließgepresst Aluminium und  
Polykarbonat klar

diffusore policarbonato  
trasparente

diffuser transparent  
polycarbonate

diffuser polycarbonate  
transparent

difusor policarbonato  
transparente

Diffuser Polykarbonat klar

III 24V c.c.

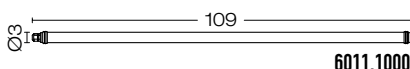
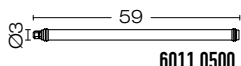

single connection  
2 Mt. cable  
-05RN-F  
included

art.		°C	W	V	Type	Ⓛ	Ra	
6011.0500L10N	○	150°	25	10	24 c.c.	4000K	1200LM	80
6011.0500L10H	○					3000K	1050LM	80
6011.1000L20N	○	150°	25	20	24 c.c.	4000K	2400LM	80
6011.1000L20H	○					3000K	2100LM	80

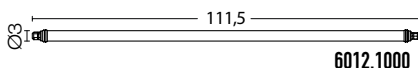
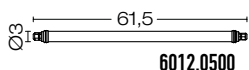

loop in loop out connection  
2x2 Mt. cable  
-05RN-F  
included

FOR TECHNICAL DETAILS VISIT  
[www.landa.it](http://www.landa.it)

IP67

art.		°C	W	V	Type	Ⓛ	Ra	
6012.0500L10N	○	150°	25	10	24 c.c.	4000K	1200LM	80
6012.0500L10H	○					3000K	1050LM	80
6012.1000L20N	○	150°	25	20	24 c.c.	4000K	2400LM	80
6012.1000L20H	○					3000K	2100LM	80

ELECTRIFICATION

**LED**

dettagli / details / details  
détalles / details:  
p.A52-A53

Energy efficiency classes

Trasformer available:

cod. 0409BT014 – GE LIGHTING IP67 24V c.c. 12W

cod. 0409BT015 – GE LIGHTING IP67 24V c.c. 25W

Trasformer on request:

cod. 0409BT016 – GE LIGHTING IP67 24V c.c. 100W

A++ ÷ A

Accessories on request:



code 0404M011  
Single connection IP68

Projectors

Recessed

NEW

Contemporary

Traditional

CONTEMPORARY



Accessories:



00A6001.01



00A6001.02



00A6001.03



00A6001.04



00A6001.05

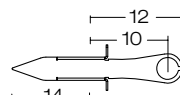
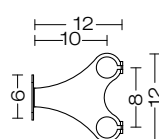
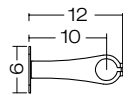

# kubs

# LED

powered by  
Citizen CLL104  
Transformer included  
Lightech IP67

simmetrico  
symmetric  
symétriques  
simétrico  
symmetrisch

example code:

art. | LED 45° | colour |  
404 | LL8X1 | H | oxi

art. | LED 45° | colour |  
404 | LL4X2 | H | nhg

art.  
**404**

designers **Gianbattista Botti & Uff. Tecnico Landa**



**404.035**

dettagli / details / details  
detalles / details: p.67

54 | CONTEMPORARY

corpo alluminio pressofuso  
body in die casting aluminium  
corps en aluminium moulé  
sous pression  
cuerpo aluminio inyectado  
Körper aus Aluminium-  
Druckguss

diffusore policarbonato  
trasparente  
diffuser transparent  
polycarbonate  
diffuser polycarbonate  
transparent  
difusor policarbonato  
transparente  
Diffuser Polykarbonat klar

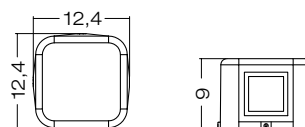
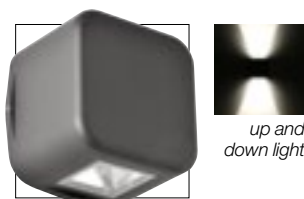
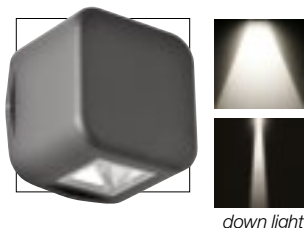

art.	Beam	W	V	Type	Light	LUX 1mt	Ra
404LS4X1H	10°	4	240	3000K	305LM	120	80
404LS8X1H	10°	8		3000K	610LM	230	80
404LL4X1H	45°	4	240	3000K	305LM	245	80
404LL8X1H	45°	8		3000K	610LM	470	80

art.	Beam	W	V	Type	Light	LUX 1mt	Ra
404LS4X2H	10°/10°	2x4	240	3000K	2x305LM	2x120	80
404LL4X2H	45°/45°	2x4	240	3000K	2x305LM	2x245	80
404LMA4X2H	45°/10°	2x4	240	3000K	2x305LM	245/120	80

FOR TECHNICAL DETAILS VISIT  
[www.landa.it](http://www.landa.it)

IP65 960°

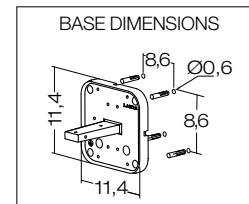
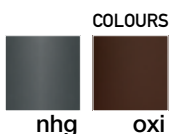

ELECTRIFICATION

# LED

dettagli / details / details  
detalles / details:  
p.A54 - A55

Energy efficiency classes



A++ ÷ A

a richiesta / on request  
sur demande / a petición  
auf Anfrage

Cool white  
5000K LED

# kubs

Projectors

Recessed

## NEW

Contemporary

Traditional

CONTEMPORARY



serie/series

# lako

# LED

powered by  
**Seoul® Semiconductor 2525**  
**AC direct connection**  
220/240V  
Transformer not required

simmetrico  
symmetric  
symétriques  
simétrico  
symmetrisch

example code:

	art.	LED	colour
409.018	L7H	X1	oxi
	art.	LED	colour
409.018	L7H	X2	nhg

## art. 409

designers **Marco Bertoli & Uff. Tecnico Landa**

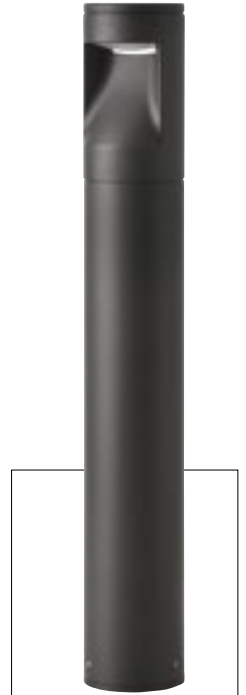

**409.040**

dettagli / details / details  
detalles / details: p.69

corpo alluminio pressofuso  
e estruso  
body in die casting and  
extruded aluminium  
corps en aluminium moulé  
sous pression et extrudé  
cuerpo aluminio inyectado y  
extrusionado  
Körper aus Aluminium-  
Druckguss



409.018L7HX1

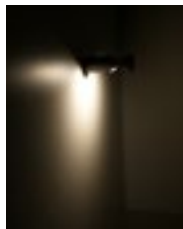

409.018L7HX2

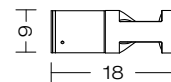
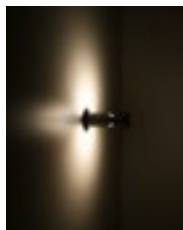

diffusore policarbonato opale  
diffuser opal polycarbonate  
diffuser polycarbonate opale  
difusor policarbonato ópalo  
Diffuser Polykarbonat opal

FOR TECHNICAL DETAILS VISIT  
[www.landa.it](http://www.landa.it)

IP65

COLOURS

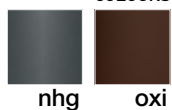

BASE DIMENSIONS

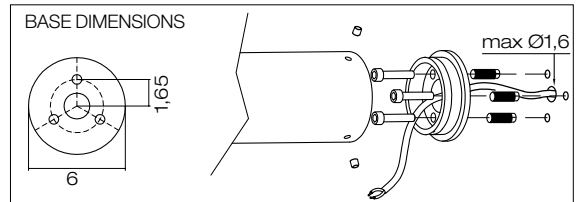

ELECTRIFICATION

# LED

dettagli / details / details  
detalles / details:  
**p.A54 - A55**

Energy efficiency classes

**L7HX1**  
LED 7 W  
3000K  
600LM  
Ra80



**L7HX2**  
LED 7 W  
3000K  
600LM  
Ra80



Included:



code **0404M009**  
Single connection IP68

lako

Projectors

Recessed

Contemporary

Traditional

CONTEMPORARY



57





serie/series

# beam

# LED

powered by  
Citizen Electronics® LED  
AC direct connection  
220/240V  
Transformer not required

simmetrico  
symmetric  
symétriques  
simétrico  
symmetrisch

example code:  
art. LED 20° colour  
456 LS20 H nhg

art.  
**456**

design Ufficio Tecnico Landa

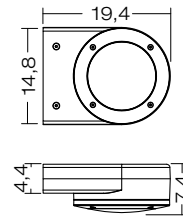

CONTEMPORARY

58 corpo alluminio pressofuso  
body in die casting aluminium  
corps en aluminium moulé  
sous pression  
cuerpo aluminio inyectado  
Körper aus Aluminium-  
Druckguss



opale  
opal / opale  
ópalo / opal

diffusore policarbonato  
diffuser polycarbonate  
diffuser polycarbonate  
difusor policarbonato  
Diffuser Polykarbonat



trasparente  
transparent  
transparent  
transparente  
klar

art.	W	V	Type	Light Bulb	LUX 1mt	Ra
456L10NB	10	220/240	4000K	1006LM	140	80
456L10HB	10	220/240	3000K	945LM	135	80
456L20NB	20	220/240	4000K	2385LM	270	80
456L20HB	20	220/240	3000K	2280LM	260	80
456GX53	13	240V		GX53		

art.	W	V	Type	Light Bulb	LUX 1mt	Ra
456LL10N	60°	10 220/240	4000K	1006LM	780	80
456LL10H	60°	10 220/240	3000K	945LM	740	80
456LL20N	60°	20 220/240	4000K	2385LM	1540	80
456LL20H	60°	20 220/240	3000K	2280LM	1460	80

art.	W	V	Type	Light Bulb	LUX 1mt	Ra
456LS10N	15°	10 220/240	4000K	1006LM	5300	80
456LS10H	15°	10 220/240	3000K	945LM	5000	80
456LS20N	20°	20 220/240	4000K	2385LM	6580	80
456LS20H	20°	20 220/240	3000K	2280LM	6250	80

FOR TECHNICAL DETAILS VISIT  
[www.landa.it](http://www.landa.it)

IP65

ELECTRIFICATION

# LED

dettagli / details / details  
detalles / details:  
p.A54 - A55

Energy efficiency classes

Transformer not required

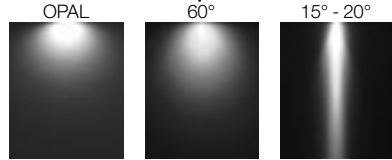

code ....L code ....LL code ....LS

GX53  
1 x max 13 W  
GX53

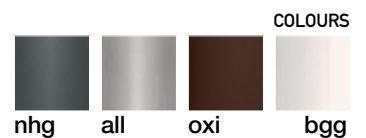
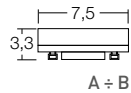

A++ ÷ A

A ÷ B

beam

Projectors

Recessed

NEW

Contemporary

Traditional

CONTEMPORARY



Accessories on request:



code 0404M004  
Single connection IP68



# dolby 2

**LED** 12W

powered by  
Seoul® Semiconductor Z5M  
Transformer included

simmetrico  
symmetric  
symétriques  
simétrico  
symmetrisch

example code:

	art.	LED 45°		colour
	457	LL12X1	H	all
	art.	LED 45°		colour
	457	LL18X2	H	nhg

art.  
**457**



design Ufficio Tecnico Landa

60 | CONTEMPORARY

corpo alluminio pressofuso  
body in die casting aluminium  
corps en aluminium moulé  
sous pression  
cuerpo aluminio inyectado  
Körper aus Aluminium-  
Druckguss

diffusore Vetro e  
PMMA trasparente  
diffuser glass and PMMA  
transparent  
diffuser verre et PMMA  
transparent  
difusor vidrio y PMMA  
transparente  
Diffuser Glas und PMMA klar

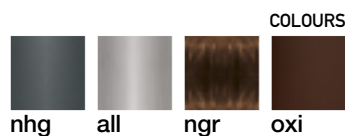
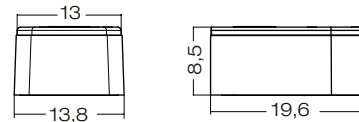
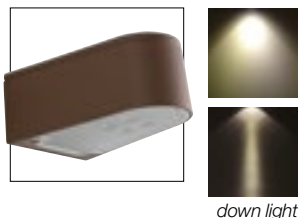

art.		W	V	Type		LUX 1mt	Ra
457LS12X1N		10°	12	220/240	4000K 840LM	10700	80
457LS12X1H		10°	12	220/240	3000K 840LM	10700	80
457LL12X1N		45°	12	220/240	4000K 840LM	720	80
457LL12X1H		45°	12	220/240	3000K 840LM	720	80



art.		W	V	Type		LUX 1mt	Ra
457LS18X2N		10°	6/12	220/240	4000K 630LM	4500	80
457LS18X2H		10°	6/12	220/240	3000K 630LM	4500	80
457LL18X2N		45°	6/12	220/240	4000K 840LM	720	80
457LL18X2H		45°	6/12	220/240	3000K 630LM	800	80
457LMA18X2N		10°/45°	6/12	220/240	4000K 630LM	4500	80
457LMA18X2H		10°/45°	6/12	220/240	3000K 630LM	4500	80
457LMA18X2H		10°/45°	6/12	220/240	3000K 840LM	720	80
457LMB18X2N		45°/10°	6/12	220/240	4000K 630LM	800	80
457LMB18X2N		45°/10°	6/12	220/240	4000K 840LM	10700	80
457LMB18X2H		45°/10°	6/12	220/240	3000K 630LM	800	80
457LMB18X2H		45°/10°	6/12	220/240	3000K 840LM	10700	80

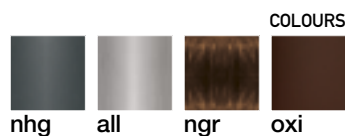

FOR TECHNICAL DETAILS VISIT  
[www.landa.it](http://www.landa.it)

IP65

ELECTRIFICATION

**LED**

dettagli / details / details  
detalles / details:  
p.A54 - A55

Energy efficiency classes

12W Transformer included

code ....LS12 code ....LL12

A++ ÷ A

dolby 2

Projectors

Recessed

NEW

Contemporary

Traditional

CONTEMPORARY



ENERGY  
SAVING

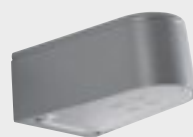

serie/series

# lyras 80

**LED**  
powered by  
Seoul® Semiconductor Z5M  
Transformer included

simmetrico  
symmetric  
symétriques  
simétrico  
symmetrisch

example code:

art. | LED 10° | colour |  
465 LL5X1 H all

art. | electrification | colour |  
465 GU10X2 all

art.  
**465**

design A. Dolcetti

OHIM:  
European Patent No.  
000346366-0003



CONTEMPORARY

corpo alluminio pressofuso  
62 body in die casting aluminium  
corps en aluminium moulé  
sous pression  
cuerpo aluminio inyectado  
Körper aus Aluminium-  
Druckguss

diffusore vetro trasparente  
diffuser glass transparent  
diffuser Verre transparent  
difusor vidrio transparente  
Diffuser Glas klar



down light  
or up light

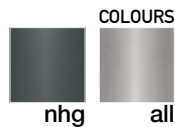

COLOURS

nhg all

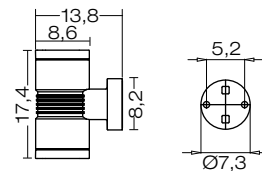

EASY INSTALLATION

art.	Beam	W	V	Type	LUX 1mtRa
465LS5X1N	10°	1x5	240	4000K 1x480LM	3740 80
465LS5X1H	10°	1x5	240	3000K 1x480LM	3740 80
465LL5X1N	40°	1x5	240	4000K 1x480LM	700 80
465LL5X1H	40°	1x5	240	3000K 1x480LM	700 80
465GU10X1		1x6		LED Megaman GU10*	
		1x9		LED Osram Parathom GU10*	
465GU5.3X1		1x8	12	LED Megaman GU5,3*	
		1x8	12	LED Osram Parathom GU5,3*	



up and  
down light

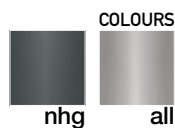

COLOURS

nhg all

art.	Beam	W	V	Type	LUX 1mtRa
465LS5X2N	10°+10°	2x5	240	4000K 2x480LM	2x3740 80
465LS5X2H	10°+10°	2x5	240	3000K 2x480LM	2x3740 80
465LL5X2N	40°+40°	2x5	240	4000K 2x480LM	2x700 80
465LL5X2H	40°+40°	2x5	240	3000K 2x480LM	2x700 80
465LM5X2N	40°+10°	2x5	240	4000K 2x480LM	3740/700 80
465LM5X2H	40°+10°	2x5	240	3000K 2x480LM	3740/700 80
465GU10X2		2x6		LED Megaman GU10*	
		2x9		LED Osram Parathom GU10*	
465GU5.3X2		2x8	12	LED Megaman GU5,3*	
		2x8	12	LED Osram Parathom GU5,3*	

FOR TECHNICAL DETAILS VISIT  
[www.landa.it](http://www.landa.it)

IP66

ELECTRIFICATION

**LED**

dettagli / details / details  
detalles / details:  
p.A54 - A55

Energy efficiency classes

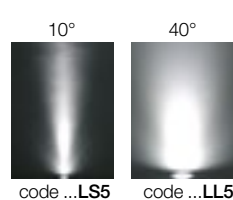

code ...LS5 code ...LL5

A++ ÷ A

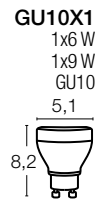

A+ ÷ E



A+ ÷ E

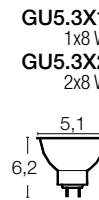

A+ ÷ E

\*Lampadine suggerite - non incluse  
\*Bulbs suggested - not included  
\*Ampoules suggéré - non inclus  
\*Glühbirne vorgeschlagen - nicht enthalten  
\*Bombillas recomienda - no incluidos

# lyras 80

Projectors

Recessed

NEW

Contemporary

Traditional

CONTEMPORARY



Thanks to KSR Lighting - UK



Accessories on request:



code 00K465.02  
Reflector for art. 465



code 00K465.01  
Visor for art. 465



serie/series

# lyras 130

**LED**  
powered by  
Seoul® Semiconductor Z5M  
Transformer included

simmetrico  
symmetric  
symétriques  
simétrico  
symmetrisch

example code:  
art. LED 10° colour  
460 LS9 H nhg

art.  
**460**

design A. Dolcetti

OHIM:  
European Patent No.  
000346366-0003



CONTEMPORARY

64

corpo alluminio pressofuso  
body in die casting aluminium  
corps en aluminium moulé  
sous pression  
cuerpo aluminio inyectado  
Körper aus Aluminium-  
Druckguss

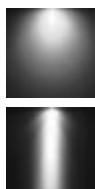

down light  
or up light

diffusore vetro trasparente  
diffuser glass transparent  
diffuser Verre transparent  
difusor vidrio transparente  
Diffuser Glas klar

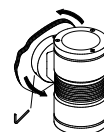
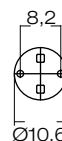
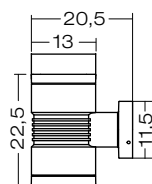
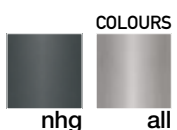

EASY INSTALLATION

art.	Beam	W	V	Type	Light Bulb	LUX at 1mt	Ra
460LS9X1N	10°	1x12	240	4000K	1x840LM	10700	80
460LS9X1H	10°	1x12	240	3000K	1x840LM	10700	80
460LL9X1N	45°	1x12	240	4000K	1x840LM	720	80
460LL9X1H	45°	1x12	240	3000K	1x840LM	720	80



up and  
down light

FOR TECHNICAL DETAILS VISIT  
[www.landa.it](http://www.landa.it)

IP66

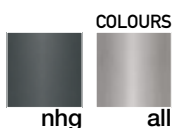

art.	Beam	W	V	Type	Light Bulb	LUX at 1mt	Ra
460LS9X2N	10°+10°	2x12	240	4000K	2x840LM	2x10700	80
460LS9X2H	10°+10°	2x12	240	3000K	2x840LM	2x10700	80
460LL9X2N	45°+45°	2x12	240	4000K	2x840LM	2x720	80
460LL9X2H	45°+45°	2x12	240	3000K	2x840LM	2x720	80
460LM9X2N	45°+10°	2x12	240	4000K	2x840LM	10700/720	80
460LM9X2H	45°+10°	2x12	240	3000K	2x840LM	10700/720	80

ELECTRIFICATION

**LED**

dettagli / details / details  
détalles / details:  
p.A54 - A55

Energy efficiency classes

Transformer included

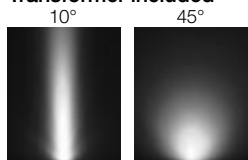

A++ ÷ A

lyras 130 (12W)



Thanks to PMR Connection - SK

Projectors

Recessed

NEW

Contemporary

Traditional

CONTEMPORARY

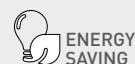

Accessories on request:

Also available with:



cod. **0201008B**  
vetro opale/opal glass/  
verre opale/vidrio ópalo/  
Glas opal



code **00K460.02**  
Reflector for art. **460**



code **00K460.01**  
Visor for art. **460**





# kubs

# LED

powered by  
Citizen CLL104  
Transformer included  
Lightech IP67

example code:

art.	finishing	size	LED	colour
404	.	012 L4X1	H	oxi

art.  
**404**

designers **Gianbattista Boti & Uff. Tecnico Landa**



**404**

dettagli / details / details  
detalles / details: p.55

66 | CONTEMPORARY

corpo alluminio pressofuso e estruso  
body in die casting and extruded aluminium  
corps en aluminium moulé sous pression et extrudé  
cuerpo aluminio inyectado y extrusionado  
Körper aus Aluminium-Druckguss

diffusore policarbonato trasparente  
diffuser transparent polycarbonate  
diffuser polycarbonate transparent  
difusor policarbonato transparente  
Diffuser Polykarbonat klar

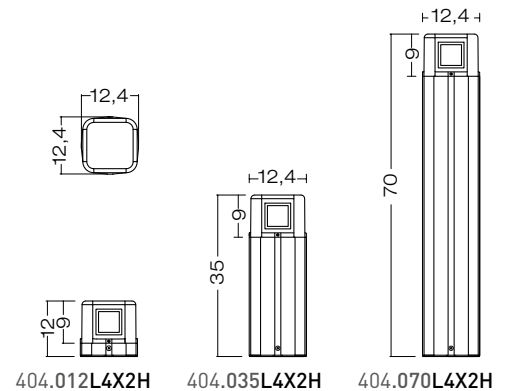
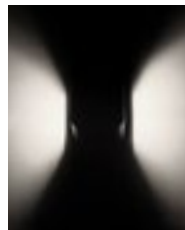
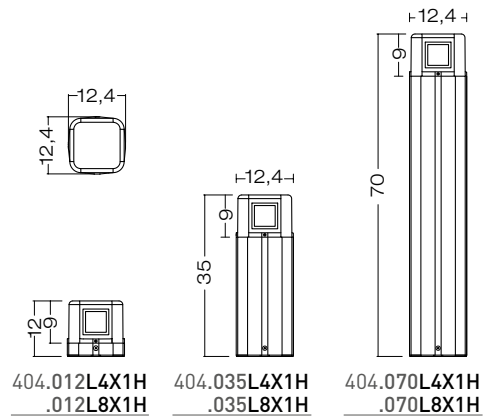
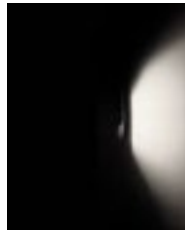

FOR TECHNICAL DETAILS VISIT  
[www.landa.it](http://www.landa.it)

IP65 960°

COLOURS

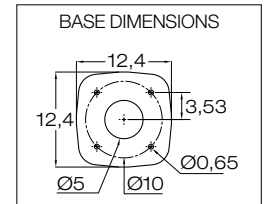
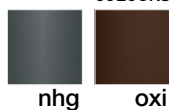

ELECTRIFICATION

# LED

dettagli / details / details  
detalles / details:  
**p.A54 - A55**

Energy efficiency classes

**L4X1H**  
LED 4 W  
3000K  
305LM  
Ra80

●  
A++ ÷ A

**L8X1H**  
LED 8 W  
3000K  
610LM  
Ra80

●  
A++ ÷ A

**L4X2H**  
LED 2x4 W  
3000K  
2x305LM  
Ra80

●  
A++ ÷ A

a richiesta / on request  
sur demande / a petición  
auf Anfrage

**Cool white  
5000K LED**

Included in:



code **O404M004**  
Single connection IP68

404.035L4X1  
.035L8X1  
.035L4X2

404.070L4X1  
.070L8X1  
.070L4X2

kubs

Projectors

Recessed

Contemporary

Traditional

CONTEMPORARY



Accessories on request:

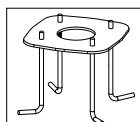

code 00A404.01P  
Anchor Bolt



code 0404M003  
Loop in loop out IP68

Available for:

- |             |             |
|-------------|-------------|
| 404.035L4X1 | 404.070L4X1 |
| .035L8X1    | .070L8X1    |
| .035L4X2    | .070L4X2    |



serie/series

# lako

# LED

powered by  
**Seoul® Semiconductor 2525**  
**AC direct connection**  
220/240V  
Transformer not required

simmetrico  
symmetric  
symétriques  
simétrico  
symmetrisch

example code:

	art.	LED	colour
409.018	L7H	X1	oxi
	art.	LED	colour
409.018	L7H	X2	nhg

## art. 409

designers **Marco Bertoli & Uff. Tecnico Landa**



409

dettagli / details / details  
detalles / details: p.57

CONTEMPORARY

corpo alluminio pressofuso  
e estruso  
body in die casting and  
extruded aluminium  
corps en aluminium moulé  
sous pression et extrudé  
cuerpo aluminio inyectado y  
extrusionado  
Körper aus Aluminium-  
Druckguss

diffusore policarbonato opale  
diffuser opal polycarbonate  
diffuser polycarbonate opale  
difusor policarbonato ópalo  
Diffuser Polykarbonat opal

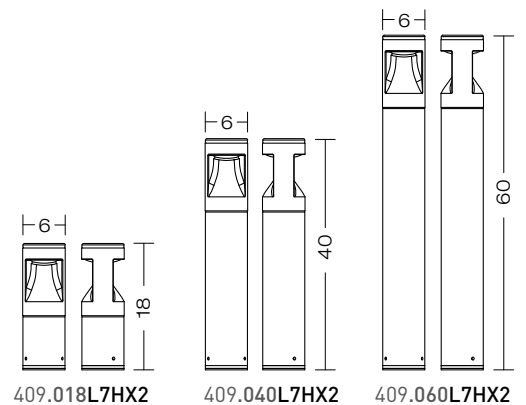
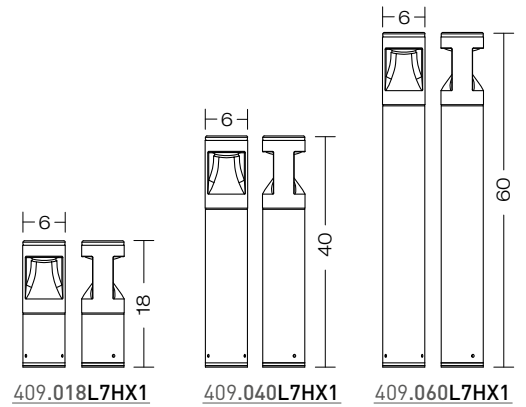

FOR TECHNICAL DETAILS VISIT  
[www.landa.it](http://www.landa.it)

IP65

COLOURS

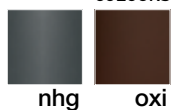

nhg

oxi

BASE DIMENSIONS

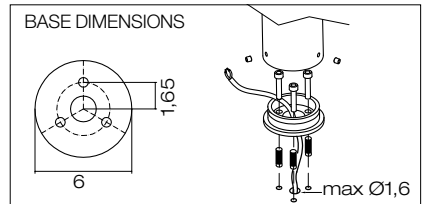

ELECTRIFICATION

# LED

dettagli / details / details  
detalles / details:  
p.A54 - A55

Energy efficiency classes

**L7HX1**  
LED 7 W  
3000K  
600LM  
Ra80

A++ ÷ A

**L7HX2**  
LED 7 W  
3000K  
600LM  
Ra80

A++ ÷ A

Included in:



409.018L7HX1  
.018L7HX2

code **O404M009**  
Single connection IP68



409.040L7HX1  
.060L7HX1  
.040L7HX2  
.060L7HX2

code **O404M004**  
Single connection IP68

lako

Projectors

Recessed

Contemporary

Traditional

CONTEMPORARY



Accessory on request:

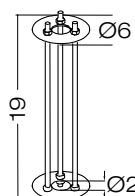
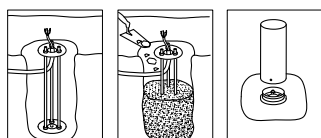

code **00A409**  
Root Mounting Kit



serie/series

# sunny

# LED

powered by  
Seoul® Semiconductor 5630  
Transformer included

example code:

| art. | finishing | size | LED | colour |  
407 . 075 L12 H nhg

art.  
**407**

designers **Marco Bertoli  
& Uff. Tecnico Landa**

OHIM:  
European Patent No.  
001982653-0001

Chinese Patent No.  
HC-IP Agency Co., LTD  
patent pending

CONTEMPORARY  
70

corpo alluminio EN47000  
body EN47000 aluminium  
corps EN47000 aluminium  
cuerpo aluminio EN47000  
Körper EN47000 Aluminium

diffusore policarbonato frosted  
diffuser frosted polycarbonate  
diffuser polycarbonate frosted  
difusor policarbonato frosted  
Diffuser Polykarbonat frosted

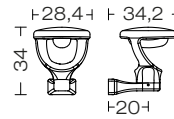

407.00L12  
.00L12H



407.035L12  
.035L12H



407.050L12  
.050L12H

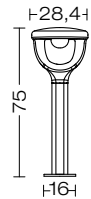

407.075L12  
.075L12H

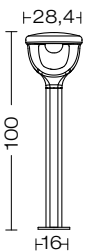

407.100L12  
.100L12H

FOR TECHNICAL DETAILS VISIT  
[www.landa.it](http://www.landa.it)

IP65 960°

COLOURS

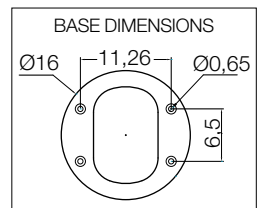
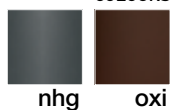

ELECTRIFICATION

# LED

dettagli / details / details  
détalles / details:  
p.A54 - A55

Energy efficiency classes

**L12**  
LED 10 W  
5000K  
1300LM  
Ra80



A++ ÷ A

**L12H**  
LED 10 W  
3000K  
1150LM  
Ra80



A++ ÷ A

Included:



code **0404M004**  
Single connection IP68

sunny

Projectors

Recessed

Contemporary

Traditional

CONTEMPORARY



71



Accessories on request:



code 0404M003  
Loop in loop out IP68

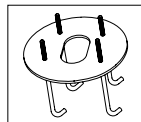

code 00A407.01P  
Anchor Bolt



serie/series

# sunny

# LED

powered by  
Seoul® Semiconductor 5630  
Transformer included

example code:

| art. | finishing | size | LED | colour |  
408 . 100 L12 H nhg

art.  
**408**

designers **Marco Bertoli  
& Uff. Tecnico Landa**

**OHIM:**  
European Patent No.  
001982653-0001

Chinese Patent No.  
HC-IP Agency Co., LTD  
patent pending

CONTEMPORARY  
72

corpo alluminio EN47000  
body EN47000 aluminium  
corps EN47000 aluminium  
cuerpo aluminio EN47000  
Körper EN47000 Aluminium

diffusore policarbonato frosted  
diffuser frosted polycarbonate  
diffuser polycarbonate frosted  
difusor policarbonato frosted  
Diffuser Polykarbonat frosted

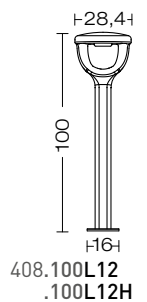
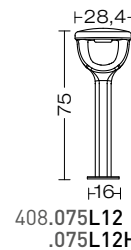
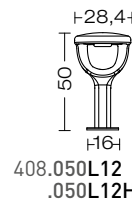
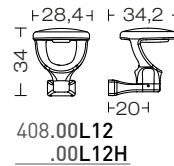

FOR TECHNICAL DETAILS VISIT  
[www.landa.it](http://www.landa.it)

IP65 960°

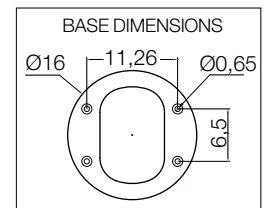
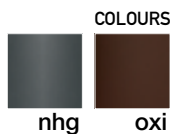

ELECTRIFICATION

# LED

dettagli / details / details  
détalles / details:  
**p.A54 - A55**

Energy efficiency classes

**L12**  
LED 10 W  
5000K  
1300LM  
Ra80



A++ ÷ A

**L12H**  
LED 10 W  
3000K  
1150LM  
Ra80



A++ ÷ A

Included:



code **0404M004**  
Single connection IP68

sunny

Projectors

Recessed

Contemporary

Traditional

CONTEMPORARY



73



Accessories on request:



code 0404M003  
Loop in loop out IP68

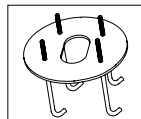

code 00A407.01P  
Anchor Bolt





# morphis

# LED

powered by  
Citizen Electronics® LED  
Transformer included

example code:

art.	LED	○	size	colour
175	L24	H	.00	ngg

art.	electrification	size	colour
175	H70	.00	ngr

art.  
**175**

designers **Innocenzo Rifino  
& Lorenzo Ruggieri**



**175**

dettagli / details / details  
detalles / details: p.87

**OHIM:**  
European Patent No.  
001810037-001

Chinese Patent No.  
HC-IP Agency Co., LTD  
CN - 302520755 S

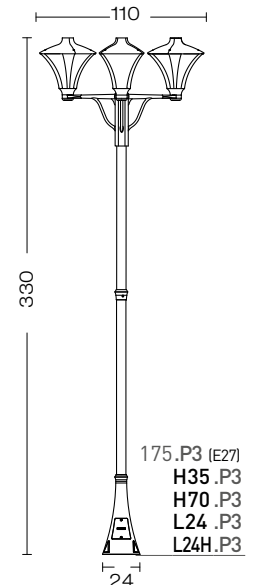
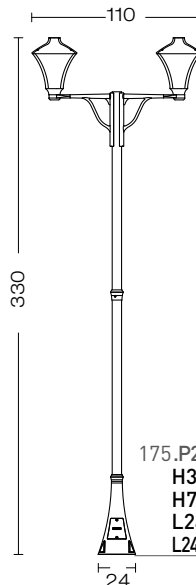
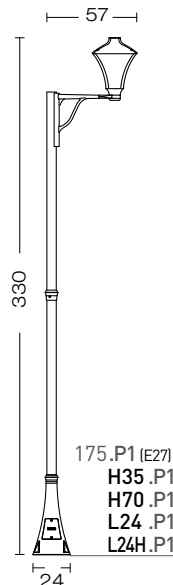
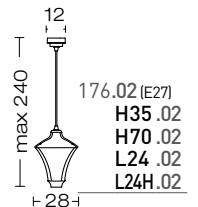
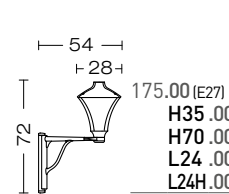
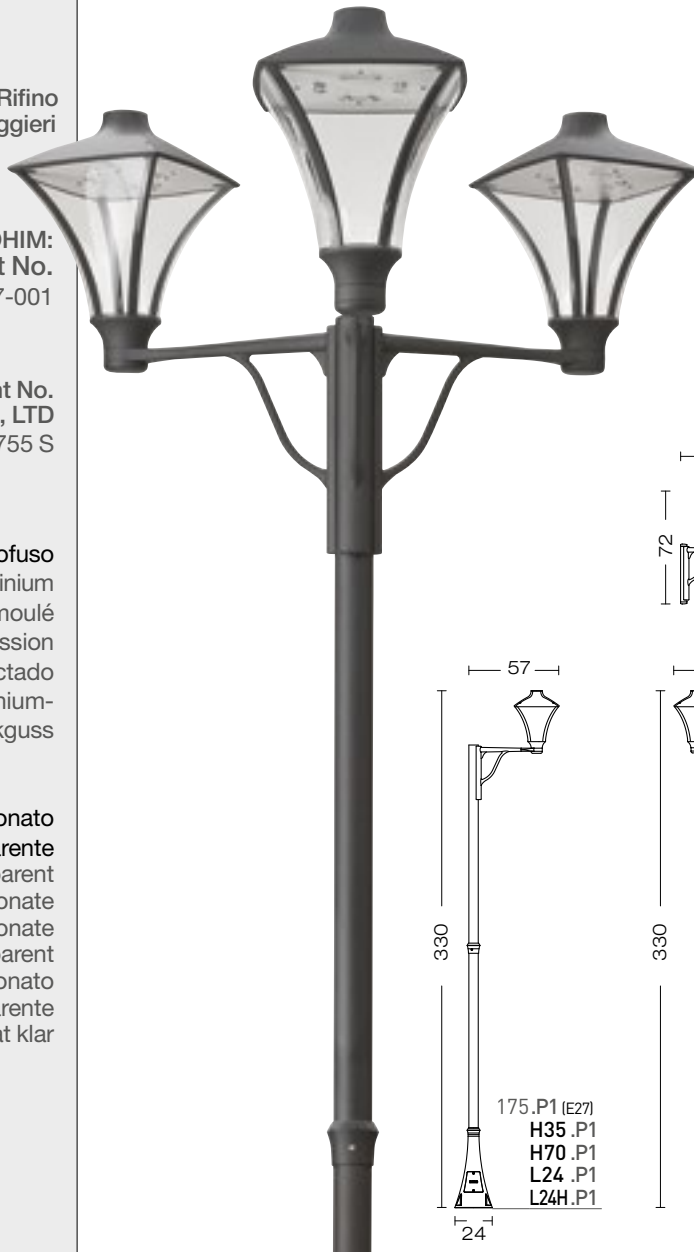

CONTEMPORARY

74

corpo alluminio pressofuso  
body in die casting aluminium  
corps en aluminium moulé  
sous pression  
cuerpo aluminio inyectado  
Körper aus Aluminium-  
Druckguss

diffusore policarbonato  
trasparente  
diffuser transparent  
polycarbonate  
diffuser polycarbonate  
transparent  
difusor policarbonato  
transparente  
Diffuser Polykarbonat klar

FOR TECHNICAL DETAILS VISIT  
[www.landa.it](http://www.landa.it)

IP65 960°

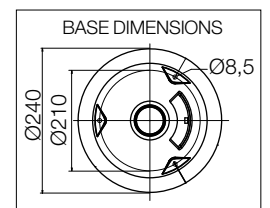
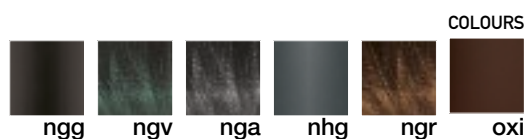

ELECTRIFICATION

# LED

dettagli / details / details  
detalles / details:  
p.A54 - A55

Energy efficiency classes

**L24**  
LED 24 W  
5000K  
3040LM  
Ra70



A++ ÷ A

**L24H**  
LED 24 W  
3000K  
2440LM  
Ra85



A++ ÷ A

**E27**  
max 30 W

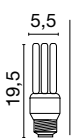

A+ ÷ E

**H35**  
1x35 W  
G12  
metal halide



A+ ÷ C

**H70**  
1x70 W  
E27  
metal halide



A+ ÷ C

Included:



code **0404M004**  
Single connection IP68

morphis

Projectors

Recessed

Contemporary

Traditional

CONTEMPORARY

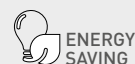

75



Accessories on request:



code 0404M003  
Loop in loop out IP68

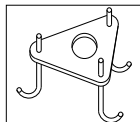

code 00A170.01P  
Anchor Bolt

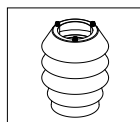

code 00KR175  
Only for: E27, F32, H35, H70

refrattore  
refractor  
réfracteur  
refractor  
Refraktor

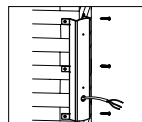

code 00596

angoliera  
corner bracket  
patte d'angle  
esquinera  
Eckhalterungen



serie/series

# morphis

# LED

powered by  
Citizen Electronics® LED  
Transformer included

example code:

art.	LED	○	size	colour
176	L24	H	.02	ngg

art.	electrification	size	colour
176	H70	.02	ngr

art.  
**176**

designers **Innocenzo Rifino  
& Lorenzo Ruggieri**

**OHIM:**  
European Patent No.  
001810037-001

**Chinese Patent No.**  
HC-IP Agency Co., LTD  
CN - 302520755 S

corpo **alluminio pressofuso**  
body in die casting aluminium  
corps en aluminium moulé  
sous pression  
cuerpo aluminio inyectado  
Körper aus Aluminium-  
Druckguss

diffusore **polycarbonato**  
**trasparente**  
diffuser transparent  
polycarbonate  
diffuser polycarbonate  
transparent  
difusor polycarbonato  
transparente  
Diffuser Polykarbonat klar



**175**

dettagli / details / details  
detalles / details: p.87

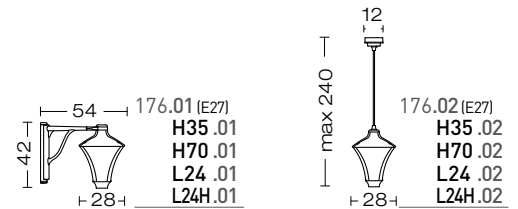

176.01 (E27)  
H35 .01  
H70 .01  
L24 .01  
L24H.01

max 240  
176.02 (E27)  
H35 .02  
H70 .02  
L24 .02  
L24H.02

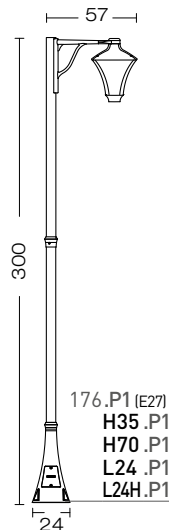

176.P1 (E27)  
H35 .P1  
H70 .P1  
L24 .P1  
L24H.P1

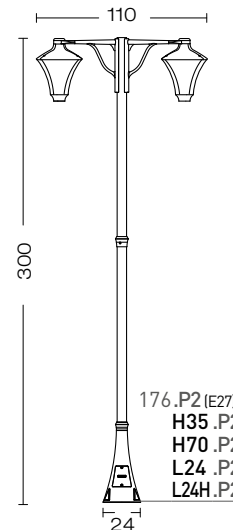

176.P2 (E27)  
H35 .P2  
H70 .P2  
L24 .P2  
L24H.P2

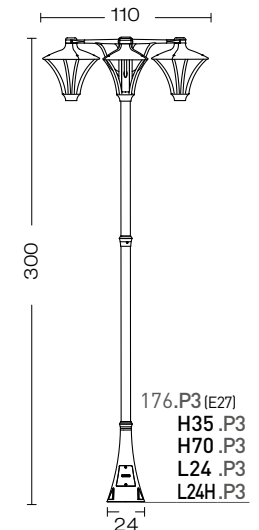

176.P3 (E27)  
H35 .P3  
H70 .P3  
L24 .P3  
L24H.P3

FOR TECHNICAL DETAILS VISIT  
[www.landa.it](http://www.landa.it)

IP65 960°

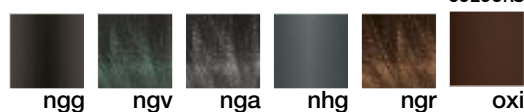

COLOURS

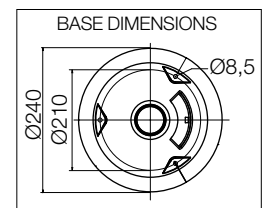

ELECTRIFICATION

# LED

dettagli / details / details  
detalles / details:  
p.A54 - A55

Energy efficiency classes

**L24**  
LED 24 W  
5000K  
3040LM  
Ra70



A++ ÷ A

**L24H**  
LED 24 W  
3000K  
2440LM  
Ra85



A++ ÷ A

**E27**  
max 30 W  
5,5

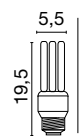

A+ ÷ E

**H35**  
1x35 W  
G12  
metal halide

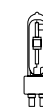

A+ ÷ C

**H70**  
1x70 W  
E27  
metal halide



A+ ÷ C

Included:



code **0404M004**  
Single connection IP68

morphis

Projectors

Recessed

Contemporary

Traditional

CONTEMPORARY

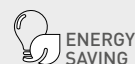

Accessories on request:



code **0404M003**  
Loop in loop out IP68

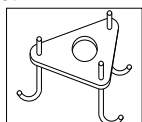

code **00A170.01P**  
Anchor Bolt

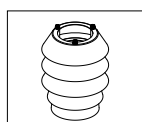

code **00KR175**  
Only for: E27, F32, H35, H70

refrattore  
refractor  
réfracteur  
refractor  
Refraktor

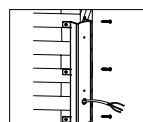

code **00596**

angoliera  
corner bracket  
patte d'angle  
esquinera  
Eckhalterungen



serie/series

# morphis

# LED

powered by  
Citizen Electronics® LED  
Transformer included

example code:

art.	size	LED	○	colour
177	.095	L24	H	ngg

art.	size	electrification	colour
177	.095	H70	ngr

art.  
**177**

designers **Innocenzo Rifino & Lorenzo Ruggieri**

**OHIM:**  
European Patent No.  
001810037-001

**Chinese Patent No.**  
HC-IP Agency Co., LTD  
CN - 302520755 S

78 | CONTEMPORARY

corpo **alluminio pressofuso**  
body in die casting aluminium  
corps en aluminium moulé  
sous pression  
cuerpo aluminio inyectado  
Körper aus Aluminium-  
Druckguss

diffusore **policarbonato**  
**trasparente**  
diffuser transparent  
polycarbonate  
diffuser polycarbonate  
transparent  
difusor policarbonato  
transparente  
Diffuser Polykarbonat klar



FOR TECHNICAL DETAILS VISIT  
[www.landa.it](http://www.landa.it)

IP65 96°

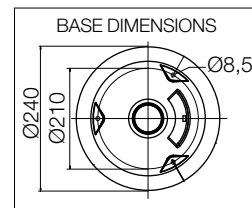
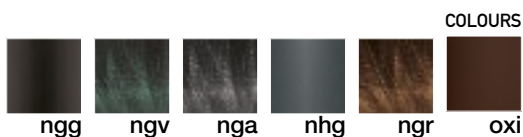

ELECTRIFICATION

# LED

dettagli / details / details  
détalles / details:  
p.A54 - A55

Energy efficiency classes

<p><b>L24</b> LED 24 W 5000K 3040LM Ra70</p> <p>A++ ÷ A</p>	<p><b>L24H</b> LED 24 W 3000K 2440LM Ra85</p> <p>A++ ÷ A</p>	<p><b>E27</b> max 30 W</p> <p>A+ ÷ E</p>	<p><b>H35</b> 1x35 W G12 metal halide</p> <p>A+ ÷ C</p>	<p><b>H70</b> 1x70 W E27 metal halide</p> <p>A+ ÷ C</p>
---	--	--	---	---

Included:



code **0404M004**  
Single connection IP68

morphis



Thanks to: SI - RU

Projectors

Recessed

Contemporary

Traditional

CONTEMPORARY



Thanks to: Martin Fukna - PMR connection SK



Accessories on request:



code 0404M003  
Loop in loop out IP68

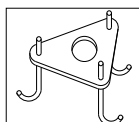

code 00A170.01P  
Anchor Bolt

Accessories not available for:  
177.33 (E27)  
.33H35  
.33H70  
.33L24  
.33L24H

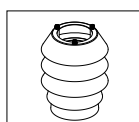

code 00KR175  
Only for: E27, F32, H35, H70

refrattore  
refractor  
réfracteur  
refractor  
Refraktor



serie/series

# morphis

# LED

powered by  
Citizen Electronics® LED  
Transformer included

example code:

art.	LED	○	size	colour
178	L24	H	.01	ngg

art.  
**178**

designers **Innocenzo Rifino  
& Lorenzo Ruggieri**

**OHIM:**  
European Patent No.  
001810037-001

**Chinese Patent No.**  
HC-IP Agency Co., LTD  
CN - 302520755 S

corpo **alluminio pressofuso**  
body in die casting aluminium  
corps en aluminium moulé  
sous pression  
cuerpo aluminio inyectado  
Körper aus Aluminium-  
Druckguss

diffusore **polycarbonato**  
**trasparente**  
diffuser transparent  
polycarbonate  
diffuser polycarbonate  
transparent  
difusor polycarbonato  
transparente  
Diffuser Polykarbonat klar

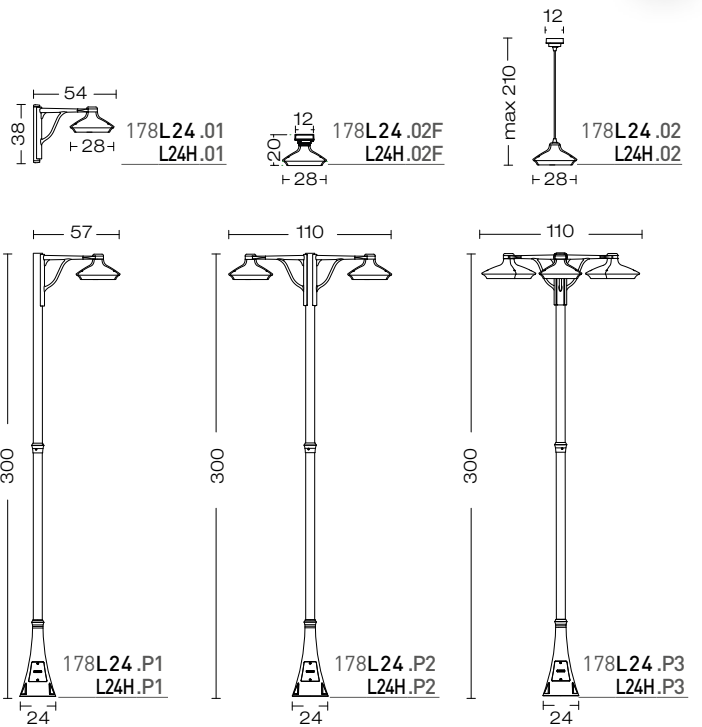
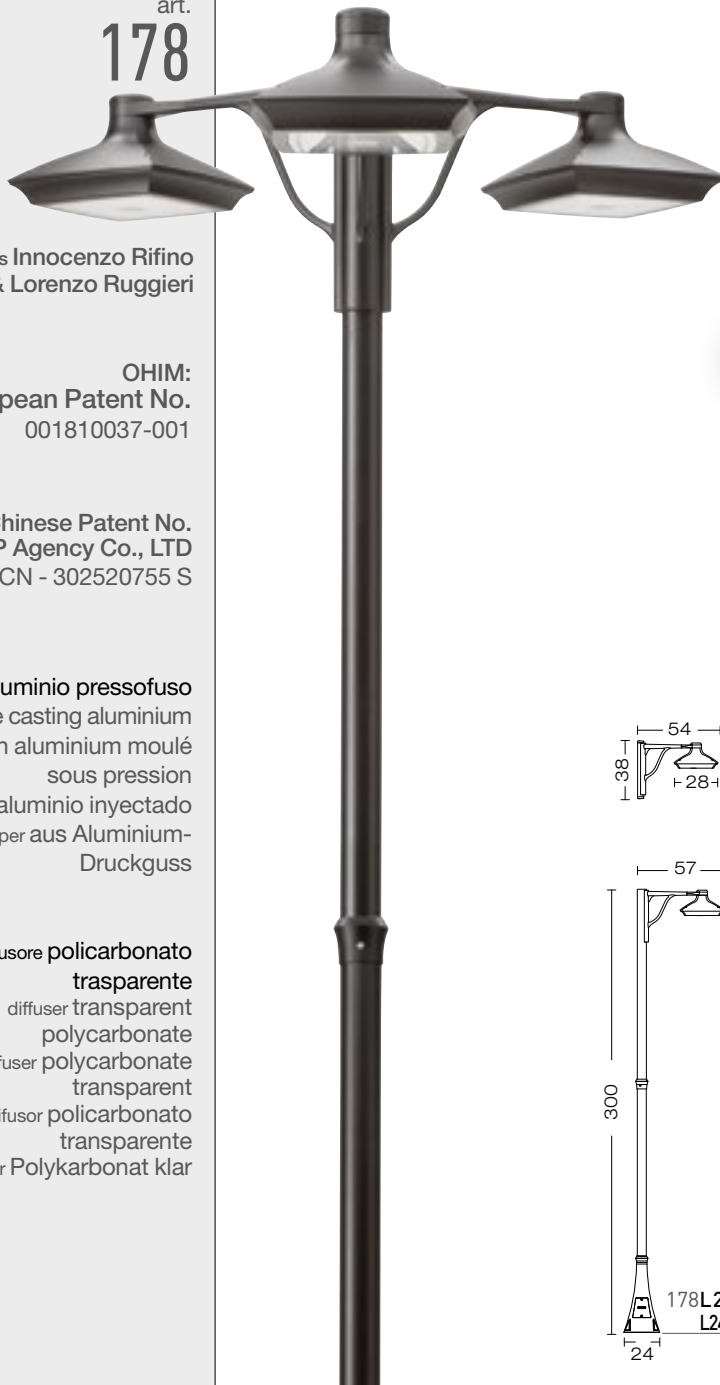

FOR TECHNICAL DETAILS VISIT  
[www.landa.it](http://www.landa.it)

IP65 96°

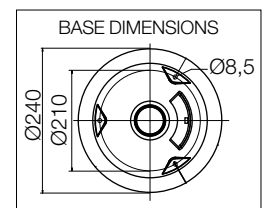
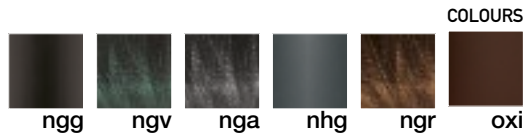

ELECTRIFICATION

# LED

dettagli / details / details  
detales / details:  
**p.A54 - A55**

Energy efficiency classes

<b>L24</b> LED 24 W 5000K 3040LM Ra70	<b>L24H</b> LED 24 W 3000K 2440LM Ra85
---	--

○	○
A++ ÷ A	A++ ÷ A

Included:



code **0404M004**  
Single connection IP68

morphis

Projectors

Recessed

Contemporary

Traditional

CONTEMPORARY



81



**morphis**  
cod. 180L24.P2 ngg  
pagg. 84-85

Accessories on request:



code 0404M003  
Loop in loop out IP68

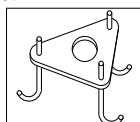

code 00A170.01P  
Anchor Bolt

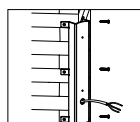

code 00596  
angoliera  
corner bracket  
patte d'angle  
esquinera  
Eckhalterungen





# morphis

# LED

powered by  
Citizen Electronics® LED  
Transformer included

example code:

art.	LED	○	size	colour
179	L24	H	.01	ngg

art.	electrification	size	colour
179	H70	.01	ngr

art.  
**179**

designers **Innocenzo Rifino & Lorenzo Ruggieri**

**OHIM:**  
European Patent No.  
001810037-001

**Chinese Patent No.**  
HC-IP Agency Co., LTD  
CN - 302520755 S

corpo **alluminio pressofuso**  
body in die casting aluminium  
corps en aluminium moulé  
sous pression  
cuerpo aluminio inyectado  
Körper aus Aluminium-  
Druckguss

diffusore **polycarbonato**  
**trasparente**  
diffuser transparent  
polycarbonate  
diffuser polycarbonate  
transparent  
difusor polycarbonato  
transparente  
Diffuser Polykarbonat klar



**175**

dettagli / details / details  
detales / details: p.87

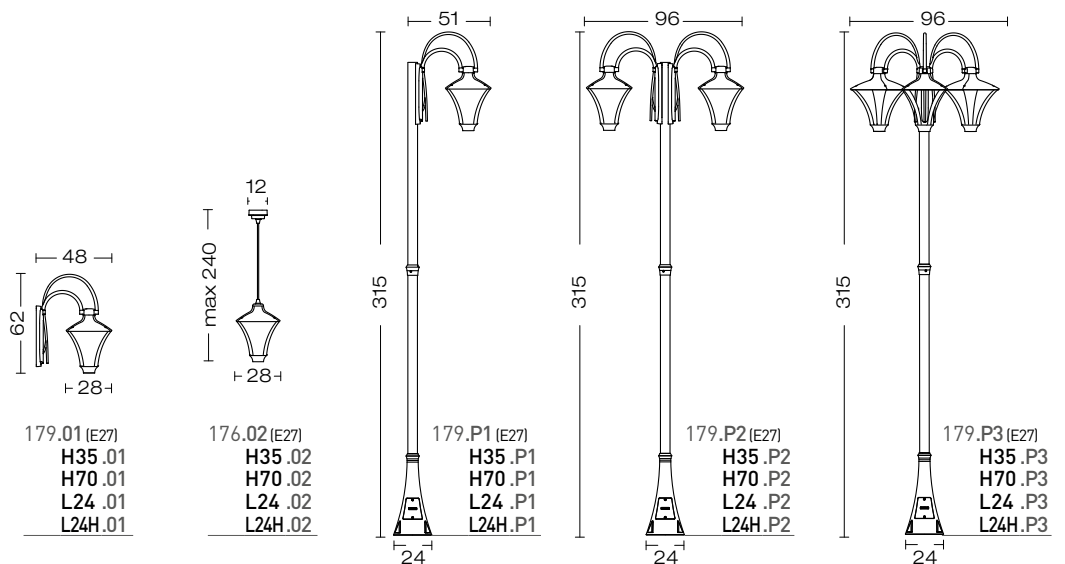

FOR TECHNICAL DETAILS VISIT  
[www.landa.it](http://www.landa.it)

IP65 960°

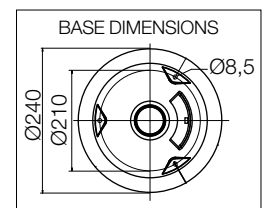
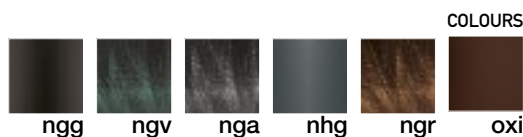

ELECTRIFICATION

# LED

dettagli / details / details  
detales / details:  
**p.A54 - A55**

Energy efficiency classes

<b>L24</b> LED 24 W 5000K 3040LM Ra70	<b>L24H</b> LED 24 W 3000K 2440LM Ra85	<b>E27</b> max 30 W 5,5 19,5	<b>H35</b> 1x35 W G12 metal halide	<b>H70</b> 1x70 W E27 metal halide
A++ ÷ A	A++ ÷ A	A+ ÷ E	A+ ÷ C	A+ ÷ C

Included:



code **0404M004**  
Single connection IP68

morphis

Projectors

Recessed

Contemporary

Traditional

CONTEMPORARY

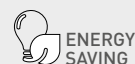

ENERGY SAVING

83



Accessories on request:



code 0404M003  
Loop in loop out IP68

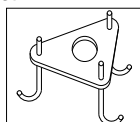

code 00A170.01P  
Anchor Bolt

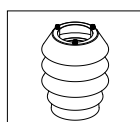

code 00KR175  
refrattore  
refractor  
réfracteur  
refractor  
Refraktor

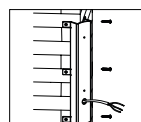

code 00596  
angoliera  
corner bracket  
patte d'angle  
esquinera  
Eckhalterungen



serie/series

# morphis

# LED

powered by  
Citizen Electronics® LED  
Transformer included

example code:  
| art. | LED |  size | colour |  
180 L24 H .01 ngg

art.  
**180**

designers **Innocenzo Rifino  
& Lorenzo Ruggieri**

**OHIM:**  
European Patent No.  
001810037-001

**Chinese Patent No.**  
HC-IP Agency Co., LTD  
CN - 302520755 S

corpo **alluminio pressofuso**  
body in die casting aluminium  
corps en aluminium moulé  
sous pression  
cuerpo aluminio inyectado  
Körper aus Aluminium-  
Druckguss

diffusore **polycarbonato**  
**trasparente**  
diffuser transparent  
polycarbonate  
diffuser polycarbonate  
transparent  
difusor polycarbonato  
transparente  
Diffuser Polykarbonat klar

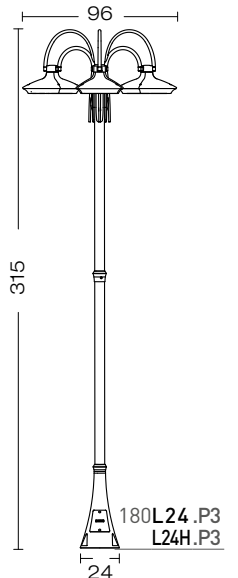
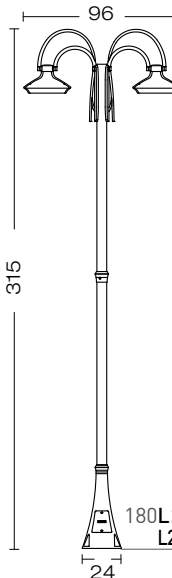
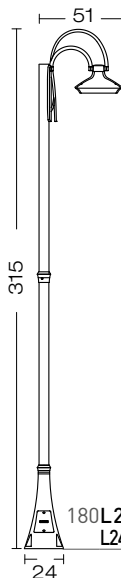
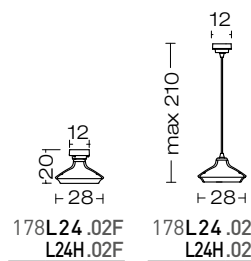
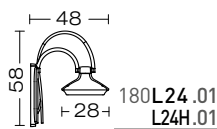

FOR TECHNICAL DETAILS VISIT  
[www.landa.it](http://www.landa.it)

IP65 

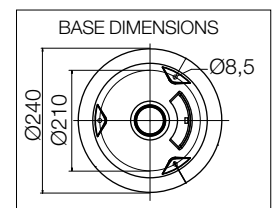
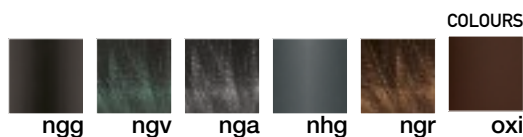



ELECTRIFICATION

# LED

dettagli / details / details  
detales / details:  
**p.A54 - A55**

Energy efficiency classes

L24	L24H
LED 24 W	LED 24 W
5000K	3000K
3040LM	2440LM
Ra70	Ra85
	
A++ ÷ A	A++ ÷ A

Included:



code **0404M004**  
Single connection IP68

morphis

Projectors

Recessed

Contemporary

Traditional

CONTEMPORARY



85



Accessories on request:



code 0404M003  
Loop in loop out IP68

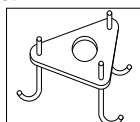

code 00A170.01P  
Anchor Bolt

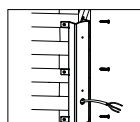

code 00596

angoliera  
corner bracket  
patte d'angle  
esquinera  
Eckhalterungen



serie/series

# morphis

# LED

powered by  
Citizen Electronics® LED  
Transformer included

example code:  
art.	LED	colour	
175	L12	H	ngr
art.	electrification	colour	
175	E27	ngr	

art.  
**175**

designers **Innocenzo Rifino  
& Lorenzo Ruggieri**

**OHIM:**  
European Patent No.  
001810037-001

Chinese Patent No.  
HC-IP Agency Co., LTD  
CN - 302520755 S



CONTEMPORARY

corpo alluminio pressofuso  
 86 body in die casting aluminium  
 corps en aluminium moulé  
 sous pression  
 cuerpo aluminio inyectado  
 Körper aus Aluminium-  
 Druckguss



175L12  
175L12H



175L12B  
175L12HB

**LED**  
powered by  
Citizen Electronics® LED  
Transformer included

diffusore policarbonato  
 diffuser polycarbonate  
 diffuser polycarbonate  
 difusor policarbonato  
 Diffuser Polykarbonat



175BSEN (E27)

**sensor** dettagli  
 details details  
 detalles detalles:  
 p.A56

FOR TECHNICAL DETAILS VISIT  
[www.landa.it](http://www.landa.it)

IP65 960°



175 (E27)



175B (E27)

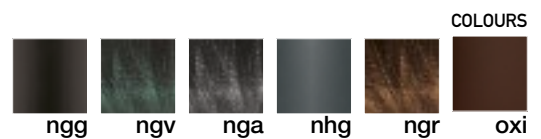
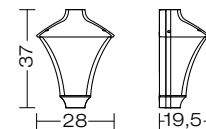

ELECTRIFICATION

# LED

dettagli / details / details  
 detalles / details:  
 p.A54 - A55

Energy efficiency classes

**L12**  
**L12B**  
 LED 12 W  
 5000K  
 1520LM  
 Ra70



A++ ÷ A

**L12H**  
**L12HB**  
 LED 12 W  
 3000K  
 1220LM  
 Ra85



A++ ÷ A

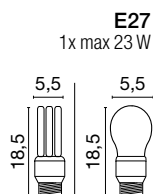

A+ ÷ E

morphis

Projectors

Recessed

Contemporary

Traditional

CONTEMPORARY



serie/series

# liberty

# LED

powered by  
Citizen Electronics® LED  
Transformer included

example code:					
art.	LED	○	size	colour	
170	LL13	H	.01	ngr	
art.	electrification		size	colour	
170	E27		.01	ngg	

## art. 170

designers Innocenzo Rifino  
& Lorenzo Ruggieri

OHIM:  
European Patent No.  
001099873-0001

Chinese Patent No.  
HC-IP Agency Co., LTD  
CN - 301266030 S

88 | CONTEMPORARY

corpo alluminio pressofuso  
body in die casting aluminium  
corps en aluminium moulé  
sous pression  
cuerpo aluminio inyectado  
Körper aus Aluminium-  
Druckguss

diffusore policarbonato  
trasparente  
diffuser transparent  
polycarbonate  
diffuser polycarbonate  
transparent  
difusor policarbonato  
transparente  
Diffuser Polykarbonat klar

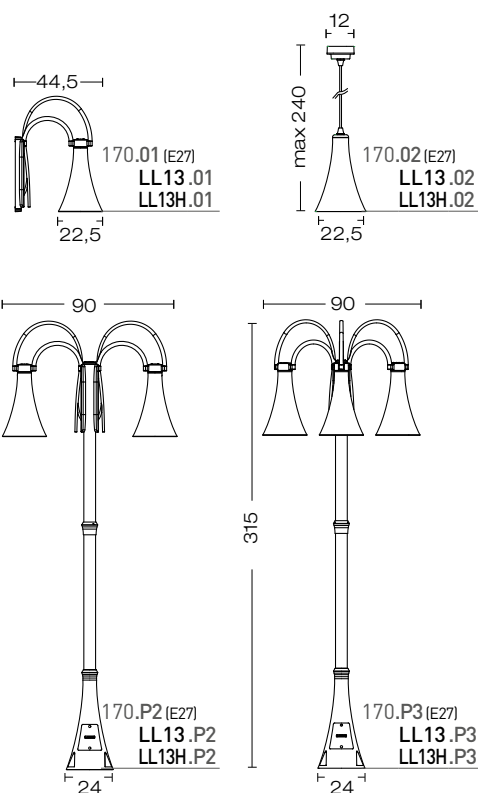

FOR TECHNICAL DETAILS VISIT  
[www.landa.it](http://www.landa.it)

IP65 96°

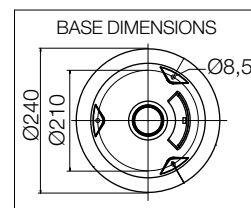
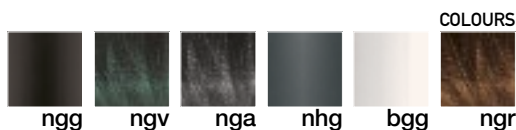

ELECTRIFICATION

# LED

dettagli / details / details  
détalles / details:  
p.A54 - A55

Energy efficiency classes

<b>LL13</b> LED 13 W 5000K 1330LM Ra70	<b>LL13H</b> LED 13 W 3000K 900LM Ra85	<b>E27</b> 1x max 23 W
○	●	16,5
A++ ÷ A	A++ ÷ A	5,3
		16,5
		5,3
		A+ ÷ E

Included:



code 0404M004  
Single connection IP68

liberty

Projectors

Recessed

NEW

Contemporary

Traditional



CONTEMPORARY



Accessories on request:



code 0404M003  
Loop in loop out IP68

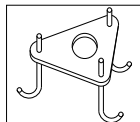

code 00A170.01P  
Anchor Bolt

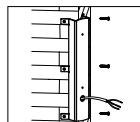

code 00596

angoliera  
corner bracket  
patte d'angle  
esquinera  
Eckhalterungen





# ivanhoe

example code:  
 | art. | electrification | size | colour |  
 470 F26 .00 nhg

art.  
**470**

designers **Innocenzo Rifino & Lorenzo Ruggieri**

progetto **Meta-Distrettuale Numa**

**OHIM:**  
 European Patent No.  
 000346366-0002

**Chinese Patent No.**  
 HC-IP Agency Co., LTD  
 patent pending

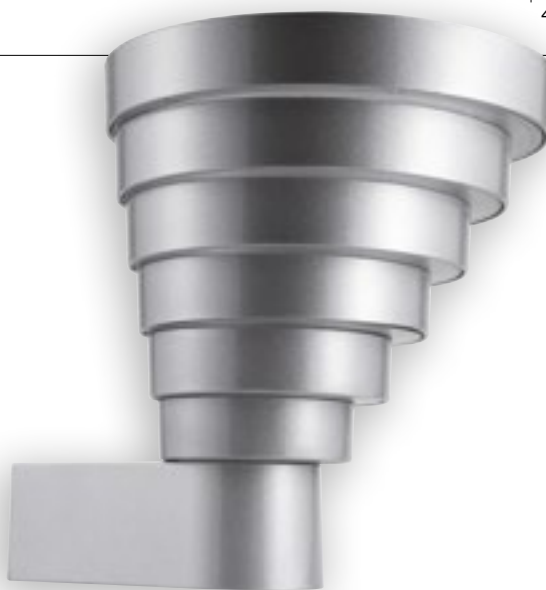

90 | CONTEMPORARY

corpo **alluminio pressofuso e estruso**  
 body in die casting and extruded aluminium  
 corps en aluminium moulé sous pression et extrudé  
 cuerpo aluminio inyectado y extrusionado  
 Körper aus Aluminium-Druckguss

diffusore **policarbonato opale**  
 diffuser opal polycarbonate  
 diffusor polycarbonate opale  
 difusor policarbonato ópalo  
 Diffuser Polykarbonat opal



UNA LAMPADA, DUE SOLUZIONI, UN PREZZO / ONE LIGHT, TWO SOLUTIONS, ONE PRICE  
 UNE LUMIÈRE, DEUX SOLUTIONS, UN PRIX / UNA LUZ, DOS SOLUCIONES, UN PRECIO  
 EINE LEUCHTE, ZWEI LÖSUNGEN, EIN PREIS

FOR TECHNICAL DETAILS VISIT  
[www.landa.it](http://www.landa.it)

IP55 96°

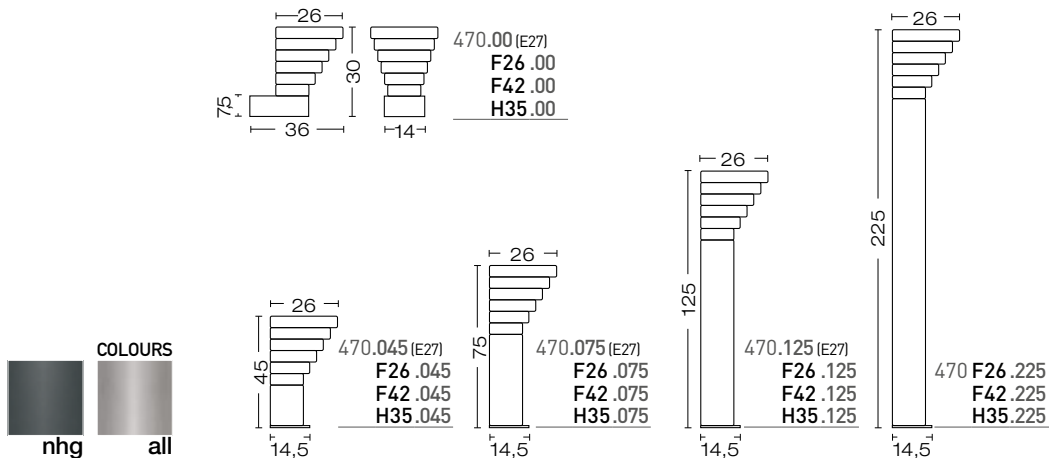

**ELECTRIFICATION**

E27	F26	F42	H35
1x max 30 W	1x26 W Gx24 q-3	1x42 W Gx24 q-4	1x35 W G12
A+ ÷ E	A+ ÷ B	A+ ÷ B	A+ ÷ C

Energy efficiency classes

ivanhoe

Projectors

Recessed

Contemporary

Traditional

CONTEMPORARY

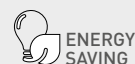

Thanks to: Illuminarte - BG



Thanks to: Illuminarte - BG



Accessories on request:



code 0404M004  
Single connection IP68



code 0404M003  
Loop in loop out IP68

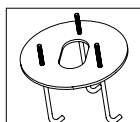

code 00A470  
Anchor Bolt



serie/series

# ibis 2 LED

# LED

powered by  
Citizen Electronics® LED  
AC direct connection  
 220/240V  
Transformer not required

example code:  
art. LED size colour  
451 L20 .00 H ngr

art.  
**451**

design aDD & Leon & Monte

progetto Meta-Distrettuale Numa

OHIM:  
European Patent No.  
000346366-0001

Chinese Patent No.  
HC-IP Agency Co., LTD  
patent pending

corpo alluminio pressofuso  
e estruso

body in die casting  
and extruded aluminium  
corps en aluminium moulé  
sous pression et extrudé  
cuerpo aluminio inyectado  
y extrusionado  
Körper aus Aluminium-  
Druckguss

diffusore policarbonato  
trasparente

diffuser transparent  
polycarbonate  
diffuser polycarbonate  
transparent  
difusor policarbonato  
transparente  
Diffuser Polykarbonat klar

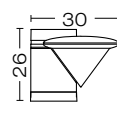
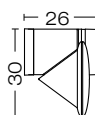

451L20.00N  
L20.00H

451L20K00N  
L20K00H

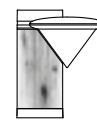
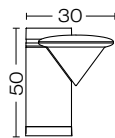

451L20.050N  
L20.050H

451L20K050N  
L20K050H

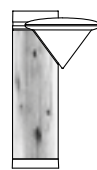
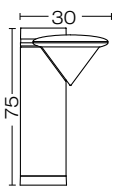

451L20.075N  
L20.075H

451L20K075N  
L20K075H

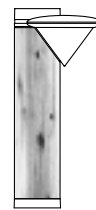
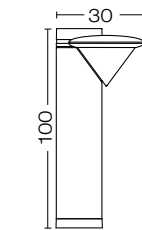

451L20.100N  
L20.100H

451L20K100N  
L20K100H

FOR TECHNICAL DETAILS VISIT  
[www.landa.it](http://www.landa.it)

IP65 960°

### FINISHING

 **K**  
dettagli / details  
/ details detalles  
/ details:  
p.A58 - A59



code 451K...

### Wood that isn't wood

Processo produttivo non inquinante  
Production process is not polluting  
C'est un procédé productif non polluant  
Proceso productivo no contaminante  
Umweltfreundlicher Herstellungsprozess

### COLOURS

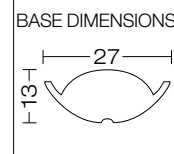

### ELECTRIFICATION

# LED

dettagli / details / details  
detales / details:  
p.A52-A53

Energy efficiency classes

L20...N  
LED 20 W  
4000K  
2385LM  
Ra80



A++ ÷ A

L20...H  
LED 20 W  
3000K  
2280LM  
Ra80



A++ ÷ A

Included:



code 0404M010  
Single connection IP68

ibis 2 LED

Projectors

Recessed

NEW

Contemporary

Traditional

CONTEMPORARY



ENERGY  
SAVING

93

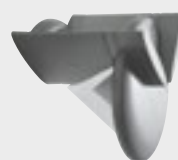

Accessories on request:

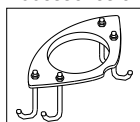

Anchor Bolt  
code 00A450



# ibis 2

art.  
**451**

design aDD & Leon & Monte

progetto Meta-Distrettuale Numa

OHIM:  
European Patent No.  
000346366-0001

Chinese Patent No.  
HC-IP Agency Co., LTD  
patent pending

corpo alluminio pressofuso  
e estruso

body in die casting  
and extruded aluminium  
corps en aluminium moulé  
sous pression et extrudé  
cuerpo aluminio inyectado  
y extrusionado  
Körper aus Aluminium-  
Druckguss

diffusore policarbonato  
trasparente

diffuser transparent  
polycarbonate  
diffuser polycarbonate  
transparent  
difusor policarbonato  
transparente  
Diffuser Polykarbonat klar

example code:				
art.	electrification	finishing	size	colour
451	E27	.	00	nhg
COUNTRY example code:				
art.	electrification	finishing	size	colour
451	E27	K	00	nhg

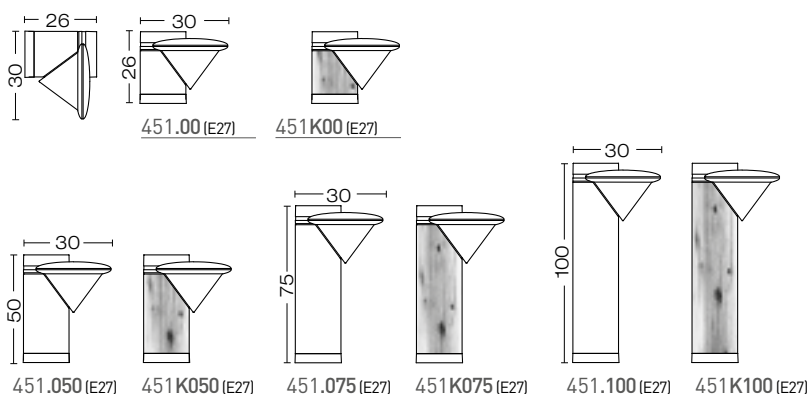

FOR TECHNICAL DETAILS VISIT  
[www.landa.it](http://www.landa.it)

IP65 960°

### FINISHING

**K**  
dettagli / details  
/ details detalles  
/ details:  
p.A58 - A59



code 451K...

### Wood that isn't wood

Processo produttivo non inquinante  
Production process is not polluting  
C'est un procédé productif non polluant  
Proceso productivo no contaminante  
Umweltfreundlicher Herstellungsprozess

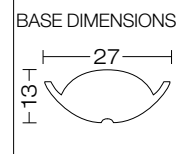
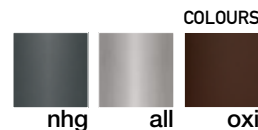

### ELECTRIFICATION

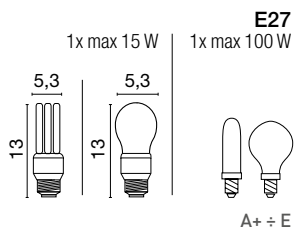

Energy efficiency classes

A+ ÷ E

### Included:



code 0404M010  
Single connection IP68

## ibis 2

Projectors

Recessed

# NEW

Contemporary

Traditional

CONTEMPORARY



95



Accessories on request:

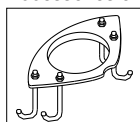

Anchor Bolt  
code 00A450



serie/series

# kami

## LED 10W

powered by  
Citizen Electronics® LED  
Transformer included

example code:  
| art. | LED | colour |  
9010 L12 H nhg

art.  
**9010**

design **Ufficio Tecnico Landa**



CONTEMPORARY

96

corpo alluminio pressofuso  
body in die casting aluminium  
corps en aluminium moulé  
sous pression  
cuerpo aluminio inyectado  
Körper aus Aluminium-  
Druckguss

diffusore policarbonato opale  
diffuser polycarbonate opal  
diffuser polycarbonate opale  
difusor policarbonato ópalo  
Diffuser Polykarbonat opal



## LED 10W

9010 L12  
L12H

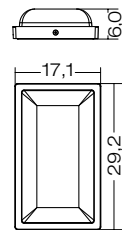

FOR TECHNICAL DETAILS VISIT  
[www.landa.it](http://www.landa.it)

IP65

850°

COLOURS



ELECTRIFICATION

## LED

dettagli /  
details / details  
detalles / detalles:  
p.A54 - A55

Energy efficiency classes

Transformer included

L12	L12H
LED 10 W	LED 10 W
5000K	3000K
1300LM	1100LM
Ra80	Ra80



# kami

Projectors

Recessed

## NEW

Contemporary

Traditional

CONTEMPORARY





serie/series

# kami

## LED 10W

powered by  
Citizen Electronics® LED  
Transformer included

example code:  
| art. | LED | colour |  
9011 L12 H nhg

art.  
**9011**



design **Ufficio Tecnico Landa**

CONTEMPORARY

98

corpo alluminio pressofuso  
body in die casting aluminium  
corps en aluminium moulé  
sous pression  
cuerpo aluminio inyectado  
Körper aus Aluminium-  
Druckguss

diffusore policarbonato opale  
diffuser polycarbonate opal  
diffuser polycarbonate opale  
difusor policarbonato ópalo  
Diffuser Polykarbonat opal



## LED 10W

9011 L12  
L12H

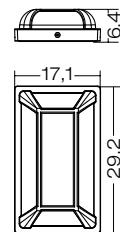

FOR TECHNICAL DETAILS VISIT  
[www.landa.it](http://www.landa.it)

IP65

850°

COLOURS



ELECTRIFICATION

## LED

dettagli /  
details / details  
detalles / details:  
p.A54 - A55

Energy efficiency classes

Transformer included

L12	L12H
LED 10 W	LED 10 W
5000K	3000K
1300LM	1100LM
Ra80	Ra80



# kami

Projectors

Recessed

## NEW

Contemporary

Traditional

CONTEMPORARY



serie/series

# oko

# LED

powered by  
Citizen Electronics® LED  
Transformer included

example code:

| art. | LED | colour |  
406 | L6 | H | nhg

| art. | electrification | colour |  
406 | F18 | nhg

art.  
**406**

designers Teseo Berghella

OHIM:  
European Patent No.  
001810037-002

Chinese Patent No.  
HC-IP Agency Co., LTD  
patent pending  
CN - 302520583 S



100 | CONTEMPORARY

corpo alluminio EN47000  
body EN47000 aluminium  
corps EN47000 aluminium  
cuerpo aluminio EN47000  
Körper EN47000 Aluminium

diffusore policarbonato frosted  
diffuser frosted polycarbonate  
diffuser polycarbonate frosted  
difusor policarbonato frosted  
Diffuser Polykarbonat frosted

FOR TECHNICAL DETAILS VISIT  
[www.landa.it](http://www.landa.it)

IP65 960°



406.L6  
406.L6H



**LED**  
powered by  
Citizen Electronics® LED  
Transformer included

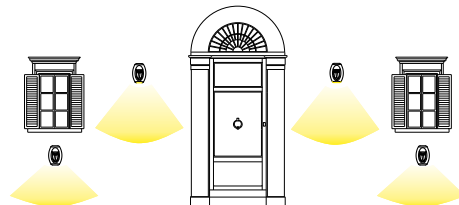
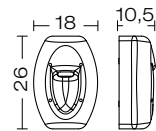

406 (E27)  
406.F18

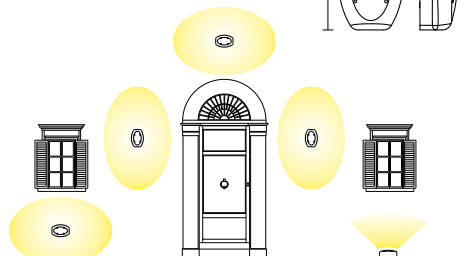
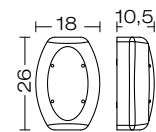
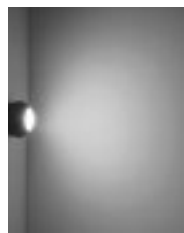

COLOURS

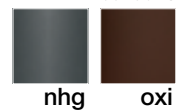

nhg

oxi

ELECTRIFICATION

# LED

dettagli / details / details  
detales / details:  
p.A54 - A55

Energy efficiency classes

**L6**  
LED 6 W  
5000K  
760LM  
Ra70



A++ ÷ A

**L6H**  
LED 6 W  
3000K  
610LM  
Ra85



A++ ÷ A

**E27**  
1x max 27 W

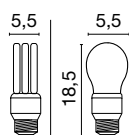

A+ ÷ E

**F18**  
1x18 W  
Gx24 q-2



A+ ÷ B

oko

Projectors

Recessed

Contemporary

Traditional

CONTEMPORARY



oko

LED

powered by  
Citizen Electronics® LED  
Transformer included

example code:

art.	size	LED	○	colour
406	.095	L6	H	nhg

art.  
**406**

designers Teseo Berghella

OHIM:  
European Patent No.  
001810037-002

Chinese Patent No.  
HC-IP Agency Co., LTD  
patent pending  
CN - 302520583 S



406

dettagli / details / details  
détalles / details: p.100



406.095L6  
L6H

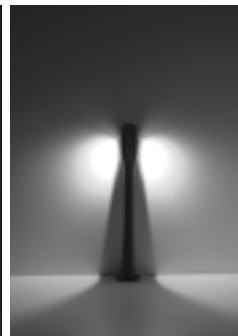

406.095L12  
L12H

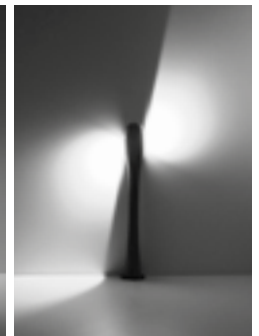

406.095LS12  
LS12H

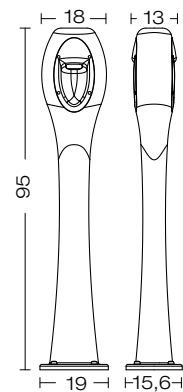

406.095L6  
.095L6H  
.095L12  
.095L12H  
.095LS12  
.095LS12H

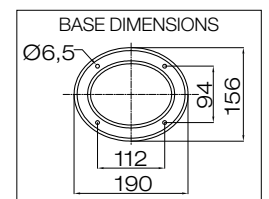

Included:



code **0404M004**  
Single connection IP68

corpo alluminio EN47000  
body EN47000 aluminium  
corps EN47000 aluminium  
cuerpo aluminio EN47000  
Körper EN47000 Aluminium

diffusore policarbonato frosted  
diffuser frosted polycarbonate  
diffuser polycarbonate frosted  
difusor policarbonato frosted  
Diffuser Polykarbonat frosted

FOR TECHNICAL DETAILS VISIT  
[www.landa.it](http://www.landa.it)

IP65 960°

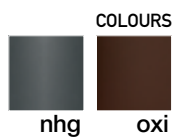

ELECTRIFICATION

LED

dettagli / details / details  
détalles / details:  
p.A54 - A55

Energy efficiency classes

**L6**  
LED 6 W  
5000K  
760LM  
Ra70



**L6H**  
LED 6 W  
3000K  
610LM  
Ra85



**L12**  
**LS12**  
LED 12 W  
5000K  
1520LM  
Ra70



**L12H**  
**LS12H**  
LED 12 W  
3000K  
1220LM  
Ra85



oko

Projectors

Recessed

Contemporary

Traditional

CONTEMPORARY



103



Thanks to: Franssen Verlichting - NL



Accessories on request:



code 0404M003  
Loop in loop out IP68



code 00A406.01P  
Anchor Bolt



# oko

example code:  
 | art. | size | electrification | colour |  
 406 .095 F26 nhg

art.  
**406**

designers Teseo Berghella

**OHIM:**  
 European Patent No.  
 001810037-002

**Chinese Patent No.**  
 HC-IP Agency Co., LTD  
 patent pending  
 CN - 302520583 S

CONTEMPORARY

104

**corpo alluminio EN47000**  
 body EN47000 aluminium  
 corps EN47000 aluminium  
 cuerpo aluminio EN47000  
 Körper EN47000 Aluminium

**diffusore policarbonato frosted**  
 diffuser frosted polycarbonate  
 diffusor polycarbonato frosted  
 difusor policarbonato frosted  
 Diffuser Polykarbonat frosted



**406**  
 dettagli / details / details  
 detalles / details: p.100

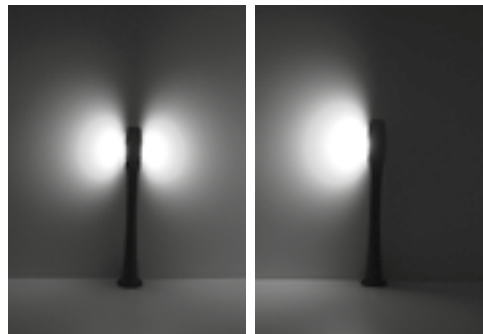

406.095(E27)  
 .095**F26**  
 .095**H35**

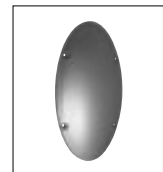

**Incluso: accessorio per monodirezione**  
 Included: monodirectional accessory  
 Inclus: accessoire monodirectionnel  
 Incluido: accesorio monodirecional  
 Beiliegend: unidirektionale Zuberhör

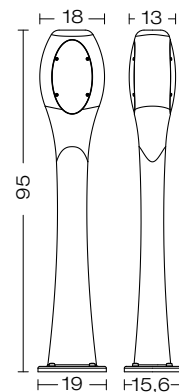

406.095(E27)  
 .095**F26**  
 .095**H35**

FOR TECHNICAL DETAILS VISIT  
[www.landa.it](http://www.landa.it)

IP65 960°

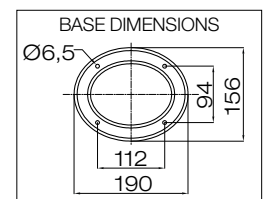
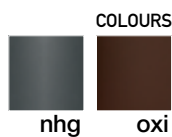

**ELECTRIFICATION**

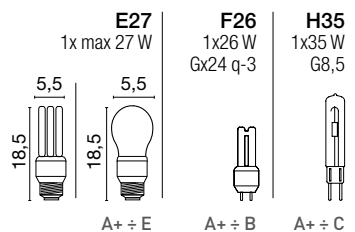

**Included:**



code **0404M004**  
 Single connection IP68

Energy efficiency classes

oko

Projectors

Recessed

Contemporary

Traditional

CONTEMPORARY



105



Accessories on request:



code 0404M003  
Loop in loop out IP68

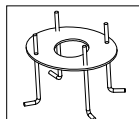

code 00A406.01P  
Anchor Bolt

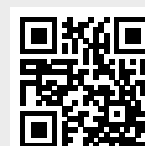



# titano

art.  
**824**

design **Ufficio Tecnico Landa**

**OHIM:**  
European Patent No.  
000508106-0002

example code:  
| art. | finishing | size | colour |  
824 · 100 oxi  
COUNTRY example code:  
| art. | finishing | size | colour |  
824 **K** 100 oxi

106 | CONTEMPORARY

corpo acciaio inox  
e alluminio estruso  
body stainless steel and  
extruded aluminium  
corps acier inoxydable  
en aluminium extrudé  
cuerpo acero inox y  
aluminio extrusionado  
Körper Edelstahl und  
Aluminium

diffusore policarbonato  
trasparente  
diffuser transparent  
polycarbonate  
diffuser polycarbonate  
transparent  
difusor policarbonato  
transparente  
Diffuser Polykarbonat klar

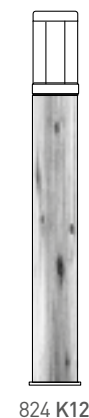
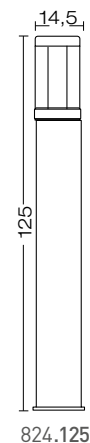
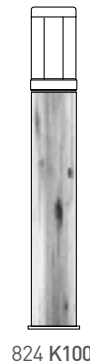
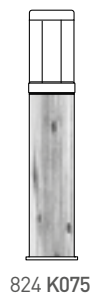
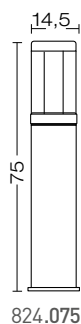
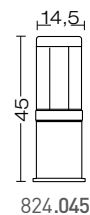
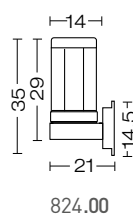

FOR TECHNICAL DETAILS VISIT  
[www.landa.it](http://www.landa.it)

IP65  
code 824.00 IP43

960°

**FINISHING**

**K**  
dettagli / details  
/ details detalles  
/ details:  
p.A58 - A59



**Wood that isn't wood**

Processo produttivo non inquinante  
Production process is not polluting  
C'est un procédé productif non polluant  
Proceso productivo no contaminante  
Umweltfreundlicher Herstellungsprozess

**COLOURS**

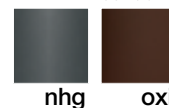

**ELECTRIFICATION**

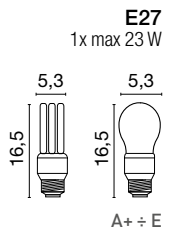

Energy efficiency classes

titano

Projectors

Recessed

Contemporary

Traditional

CONTEMPORARY

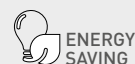

107



Accessories on request not available for: 824.00



code 0404M004  
Single connection IP68



code 0404M003  
Loop in loop out IP68

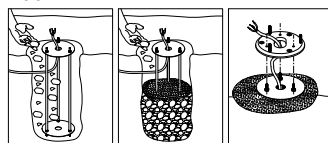

Root Mounting Kit code 00A400

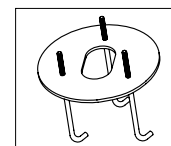
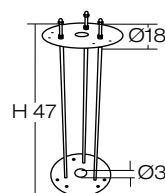

code 00A400.01P  
Anchor Bolt



# titano

# LED

powered by  
Citizen Electronics® LED  
Transformer included

example code:

art.	finishing	size	LED	○
824	K	100	L10	H

COUNTRY example code:

art.	finishing	size	LED	○
824	K	100	L10	H

art.  
**824**

design **Ufficio Tecnico Landa**

**OHIM:**  
European Patent No.  
000508106-0002



108 | CONTEMPORARY

corpo acciaio inox  
e alluminio estruso  
body stainless steel and  
extruded aluminium  
corps acier inoxydable  
en aluminium extrudé  
cuerpo acero inox y  
aluminio extrusionado  
Körper Edelstahl und  
Aluminium

diffusore policarbonato  
trasparente  
diffuser transparent  
polycarbonate  
diffuser polycarbonate  
transparent  
difusor policarbonato  
transparente  
Diffuser Polykarbonat klar

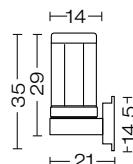

824.00L10  
.00L10H

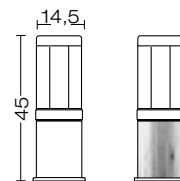

824.045L10  
.045L10H K045L10  
K045L10H

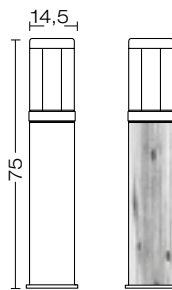

824.075L10  
.075L10H K075L10  
K075L10H

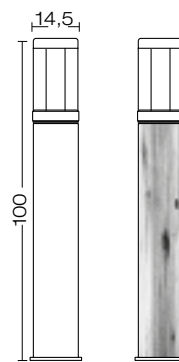

824.100L10  
.100L10H K100L10  
K100L10H

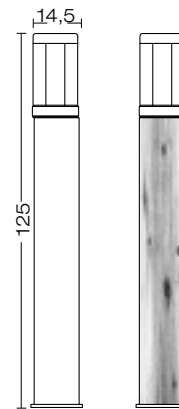

824.125L10  
.125L10H K125L10  
K125L10H

FOR TECHNICAL DETAILS VISIT  
[www.landa.it](http://www.landa.it)

IP65

code 824.00L10 IP43  
824.00L10H

960°

### FINISHING

**K**  
dettagli / details  
/ details detalles  
/ details:  
p.A58 - A59



code 824K....

### Wood that isn't wood

Processo produttivo non inquinante  
Production process is not polluting  
C'est un procédé productif non polluant  
Proceso productivo no contaminante  
Umweltfreundlicher Herstellungsprozess

### COLOURS

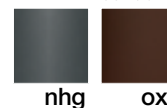

nhg

oxi

### ELECTRIFICATION

# LED

dettagli /  
details / details  
detales / details:  
p.A54 - A55

Energy efficiency classes

**L10**  
LED 10 W  
5000K  
1300LM  
Ra80



A++ ÷ A

**L10H**  
LED 10 W  
3000K  
1100LM  
Ra80



A++ ÷ A

titano

Projectors

Recessed

NEW

Contemporary

Traditional

CONTEMPORARY



Project by: Martin Fukna OMS - SK



Accessories on request not available for: 824.00L10 - 824.00L10H



code 0404M004  
Single connection IP68



code 0404M003  
Loop in loop out IP68

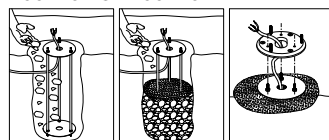

Root Mounting Kit code 00A400

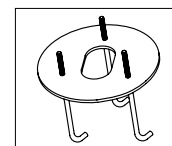
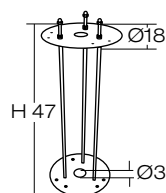

code 00A400.01P  
Anchor Bolt



# titano

art.  
**825**

design **Ufficio Tecnico Landa**

**OHIM:**  
European Patent No.  
000508106-0002

CONTEMPORARY  
110

corpo acciaio inox  
e alluminio estruso  
body stainless steel and  
extruded aluminium  
corps acier inoxydable  
en aluminium extrudé  
cuerpo acero inox y  
aluminio extrusionado  
Körper Edelstahl und  
Aluminium

diffusore policarbonato  
trasparente  
diffuser transparent  
polycarbonate  
diffuser polycarbonate  
transparent  
difusor policarbonato  
transparente  
Diffuser Polykarbonat klar



example code:				
art.	finishing	size	electrification	colour
825	.	100	E27	oxi
COUNTRY example code:				
art.	finishing	size	electrification	colour
825	K	100	E27	oxi

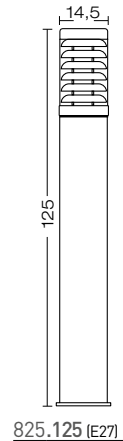
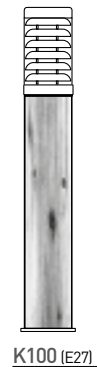
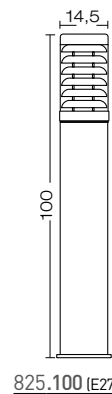
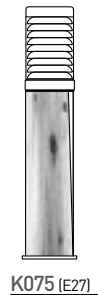
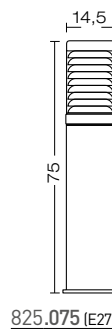
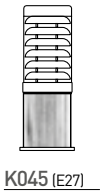
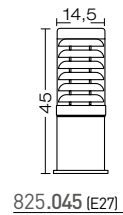
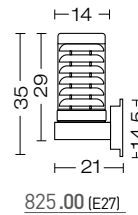

FOR TECHNICAL DETAILS VISIT  
[www.landa.it](http://www.landa.it)

IP65  
code 825.00 IP43

960°

### FINISHING



### Wood that isn't wood

Processo produttivo non inquinante  
Production process is not polluting  
C'est un procédé productif non polluant  
Proceso productivo no contaminante  
Umweltfreundlicher Herstellungsprozess

### COLOURS

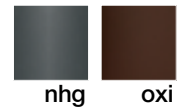

### ELECTRIFICATION

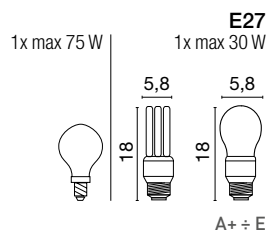

Energy efficiency classes

titano



Projectors

Recessed

Contemporary

Traditional

CONTEMPORARY

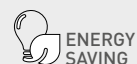

111



Accessories on request not available for: 825.00



code 0404M004  
Single connection IP68



code 0404M003  
Loop in loop out IP68

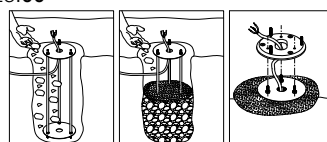

Root Mounting Kit code 00A400

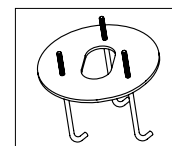
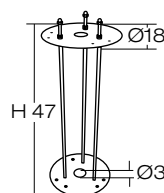

code 00A400.01P  
Anchor Bolt



serie/series

# neway

# LED

powered by:  
Vossloh 13W  
AC direct connection  
220/240V  
Transformer not required

example code:  
 | art. | LED |  | diffuser | colour |  
 405 LV12 H B all  
 | art. | electrification | colour |  
 405 E27 nhg

# art. 405 405B

designers Innocenzo Rifino  
& Lorenzo Ruggieri

OHIM:  
European Patent No.  
000659917-0003

Chinese Patent No.  
HC-IP Agency Co., LTD  
patent pending



CONTEMPORARY

112

corpo alluminio pressofuso  
body in die casting  
aluminium  
corps en aluminium moulé  
sous pression  
cuerpo aluminio inyectado  
Körper aus Aluminium-  
Druckguss

diffusore policarbonato  
diffuser polycarbonate  
diffuser polycarbonate  
difusor policarbonato  
Diffuser Polykarbonat



405LV12NBall  
405LV12HBall  
405Ball (E27)



405LV12NBnhg  
405LV12HBnhg  
405Bnhg (E27)



opale  
opal  
opale  
ópaló  
opal  
85°



405all (E27)



405nhg (E27)



trasparente  
transparent  
transparent  
transparente  
klar  
96°

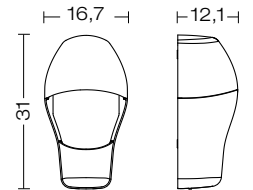

FOR TECHNICAL DETAILS VISIT  
[www.landa.it](http://www.landa.it)

IP44

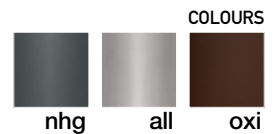

ELECTRIFICATION

# LED

dettagli / details / details  
detales / details:  
p.A54 - A55

Energy efficiency classes

LV12NB  
LED 13 W  
4000K  
1160LM  
Ra80



LV12HB  
LED 13 W  
3000K  
1140LM  
Ra80



1x max 75 W



1x max 23 W

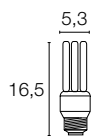

E27  
1x max 16 W

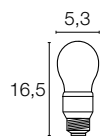

neway

Projectors

Recessed

Contemporary

Traditional



ENERGY  
SAVING

CONTEMPORARY

113





# neway

# LED

powered by  
Citizen Electronics® LED  
Transformer included

example code:

art.	finishing	size	LED	○	colour
405	.	03	L10	H	nhg

COUNTRY example code:

art.	finishing	size	LED	○	colour
405	<b>K</b>	03	L10	H	nhg

art.  
**405**

designers **Innocenzo Rifino  
& Lorenzo Ruggieri**

OHIM:  
European Patent No.  
000659917-0003

Chinese Patent No.  
HC-IP Agency Co., LTD  
patent pending

corpo alluminio pressofuso  
e estruso

body in die casting  
and extruded aluminium  
corps en aluminium moulé  
sous pression et extrudé  
cuerpo aluminio inyectado  
y extrusionado  
Körper aus Aluminium-  
Druckguss

diffusore policarbonato  
trasparente

diffuser transparent  
polycarbonate  
diffuser polycarbonate  
transparent  
difusor policarbonato  
transparente  
Diffuser Polykarbonat klar



**405B**

dettagli / details / details  
detaïles / details: p.112

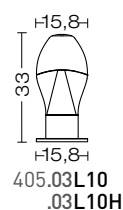

405.03L10  
.03L10H

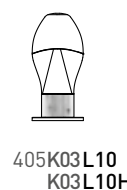

405K03L10  
K03L10H

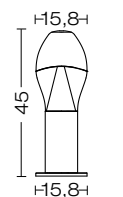

405.045L10  
.045L10H

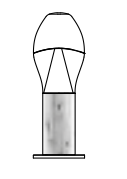

405K045L10  
K045L10H

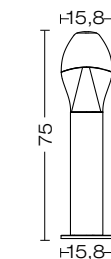

405.075L10  
.075L10H

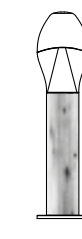

405K075L10  
K075L10H

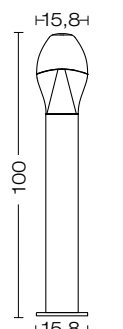

405.100L10  
.100L10H

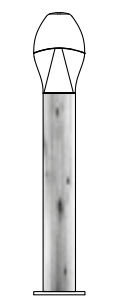

405K100L10  
K100L10H

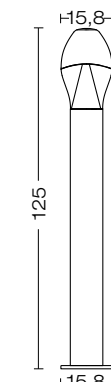

405.125L10  
.125L10H



405K125L10  
K125L10H

FOR TECHNICAL DETAILS VISIT  
[www.landa.it](http://www.landa.it)

IP65 960°

### FINISHING

**K**  
dettagli / details  
/ details detaïles  
/ details:  
p.A58 - A59



code 405K....

### Wood that isn't wood

Processo produttivo non inquinante  
Production process is not polluting  
C'est un procédé productif non polluant  
Proceso productivo no contaminante  
Umweltfreundlicher Herstellungsprozess

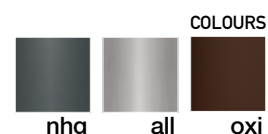

### ELECTRIFICATION

# LED

dettagli / details / details  
detaïles / details:  
p.A54 - A55

Energy efficiency classes

**L10**  
LED 10 W  
5000K  
1300LM  
Ra80



**L10H**  
LED 10 W  
3000K  
1100LM  
Ra80



### Included:



code 0404M004  
Single connection IP68

neway

Projectors

Recessed

NEW

Contemporary

Traditional

CONTEMPORARY



115



Accessories on request:



code 0404M003  
Loop in loop out IP68

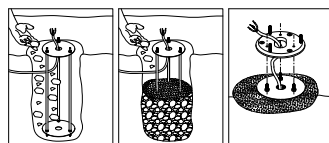

Root Mounting Kit code 00A405

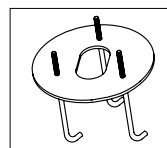
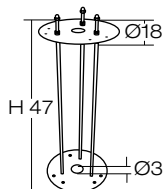

code 00A405.01P  
Anchor Bolt



# neway

example code:  
 | art. | finishing | size | electrification | colour |  
 405 . 100 E27 all

COUNTRY example code:  
 | art. | finishing | size | electrification | colour |  
 405 K 100 E27 nhg

art.  
**405**

designers **Innocenzo Rifino & Lorenzo Ruggieri**

**OHIM:**  
**European Patent No.**  
 000659917-0003

**Chinese Patent No.**  
**HC-IP Agency Co., LTD**  
 patent pending

corpo alluminio pressofuso e estruso  
 body in die casting and extruded aluminium  
 corps en aluminium moulé sous pression et extrudé  
 cuerpo aluminio inyectado y extrusionado  
 Körper aus Aluminium-Druckguss

diffusore policarbonato trasparente  
 diffuser transparent polycarbonate  
 diffuser polycarbonate transparent  
 difusor policarbonato transparente  
 Diffuser Polykarbonat klar



**405**  
 dettagli / details / details  
 detalles / details: p.112

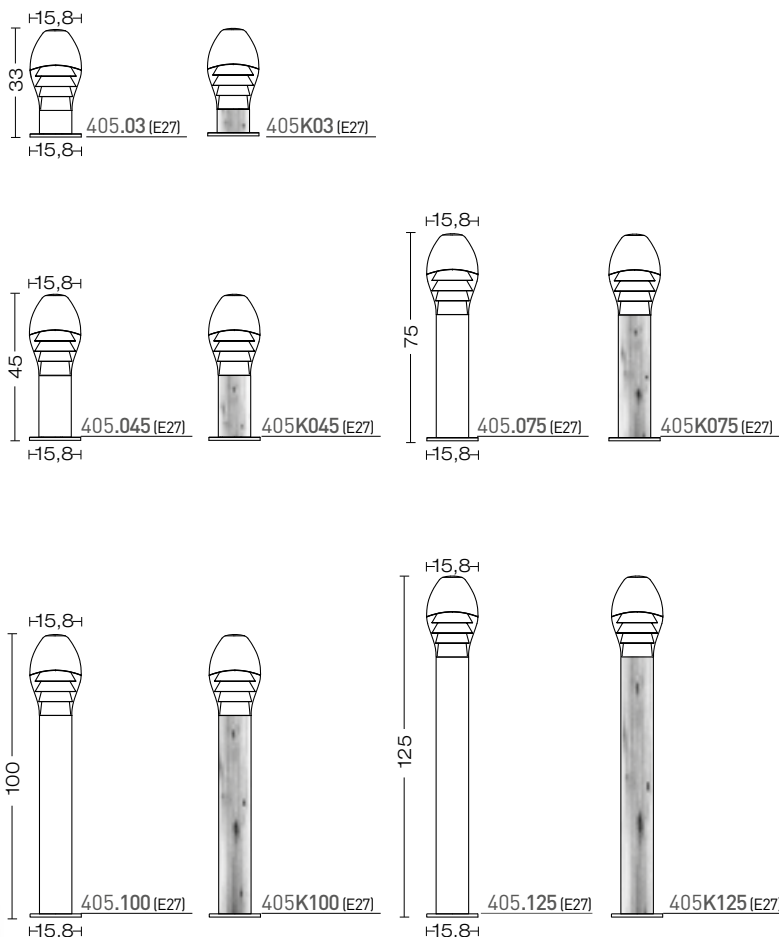

FOR TECHNICAL DETAILS VISIT  
[www.landa.it](http://www.landa.it)

IP65 96°

**FINISHING**

**K**  
 dettagli / details  
 / details detalles  
 / details: p.A58 - A59



code 405K....

**Wood that isn't wood**

Processo produttivo non inquinante  
 Production process is not polluting  
 C'est un procédé productif non polluant  
 Proceso productivo no contaminante  
 Umweltfreundlicher Herstellungsprozess

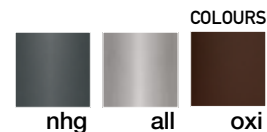

**ELECTRIFICATION**

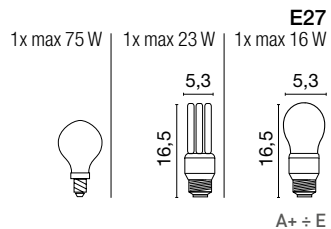

**Included:**



code 0404M004  
 Single connection IP68

Energy efficiency classes

neway

Projectors

Recessed

Contemporary

Traditional

CONTEMPORARY



117



Thanks to Ansell Lighting - UK

Accessories on request:



code 0404M003  
Loop in loop out IP68

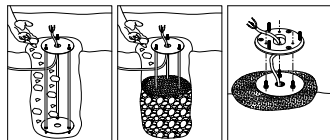

Root Mounting Kit code 00A405

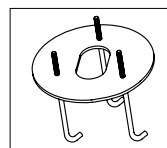
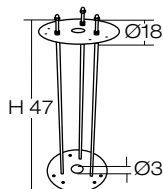

code 00A405.01P  
Anchor Bolt



# polos

art.  
**402**  
**4021**

design **Ufficio Tecnico Landa**

**OHIM:**  
European Patent No.  
000508106-0002

**corpo alluminio pressofuso e estruso**  
body in die casting and extruded aluminium  
corps en aluminium moulé sous pression et extrudé  
cuerpo aluminio inyectado y extrusionado  
Körper aus Aluminium-Druckguss

**diffusore policarbonato trasparente**  
diffuser transparent polycarbonate  
diffuser polycarbonate transparent  
difusor policarbonato transparente  
Diffuser Polykarbonat klar



example code:				
art.	finishing	size	electrification	colour
402	.	090	F18	nhg
COUNTRY example code:				
art.	finishing	size	electrification	colour
402	K	090	F18	nhg



402.10

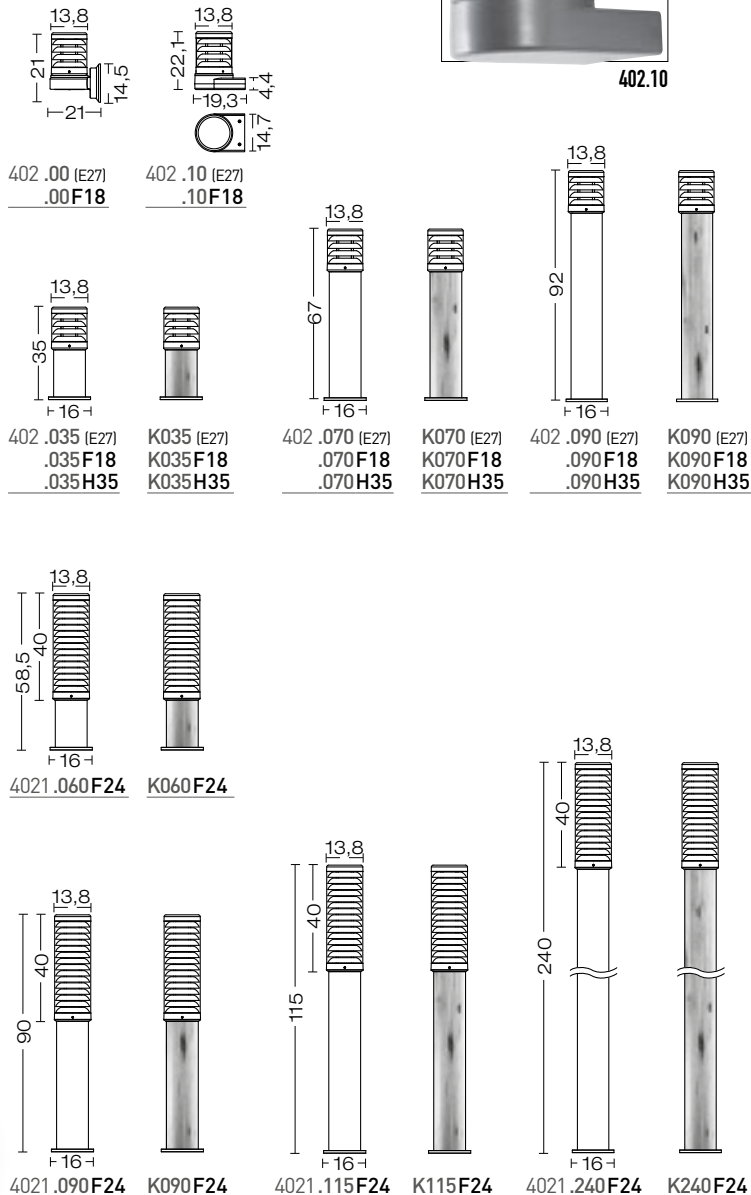

FOR TECHNICAL DETAILS VISIT  
[www.landa.it](http://www.landa.it)

IP65  
code 402.00 – 402.00F18 IP64  
402.10 – 402.10F18

960°

**FINISHING**



**Wood that isn't wood**

Processo produttivo non inquinante  
Production process is not polluting  
C'est un procédé productif non polluant  
Proceso productivo no contaminante  
Umweltfreundlicher Herstellungsprozess

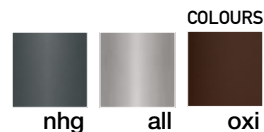

**ELECTRIFICATION**

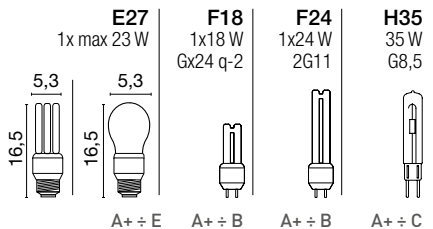

Energy efficiency classes

polos

Projectors

Recessed

NEW

Contemporary

Traditional

CONTEMPORARY



119



Thanks to Vint Dooel - MK



Accessories on request:



code 0404M004  
Single connection IP68



code 0404M003  
Loop in loop out IP68

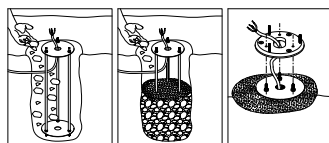

Root Mounting Kit code 00A405

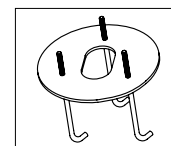
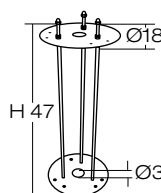

code 00A405.01P  
Anchor Bolt



# polos

art.  
**403**  
**4031**

design **Ufficio Tecnico Landa**

**OHIM:**  
European Patent No.  
000508106-0002

corpo alluminio pressofuso  
e estruso  
body in die casting  
and extruded aluminium  
corps en aluminium moulé  
sous pression et extrudé  
cuerpo aluminio inyectado  
y extrusionado  
Körper aus Aluminium-  
Druckguss

diffusore policarbonato  
trasparente  
diffuser transparent  
polycarbonate  
diffuser polycarbonate  
transparent  
difusor policarbonato  
transparente  
Diffuser Polykarbonat klar



example code:

art. finishing size LED colour  
403 K 090 L10 H nhg

COUNTRY example code:

art. finishing size LED colour  
403 K 090 L10 H nhg

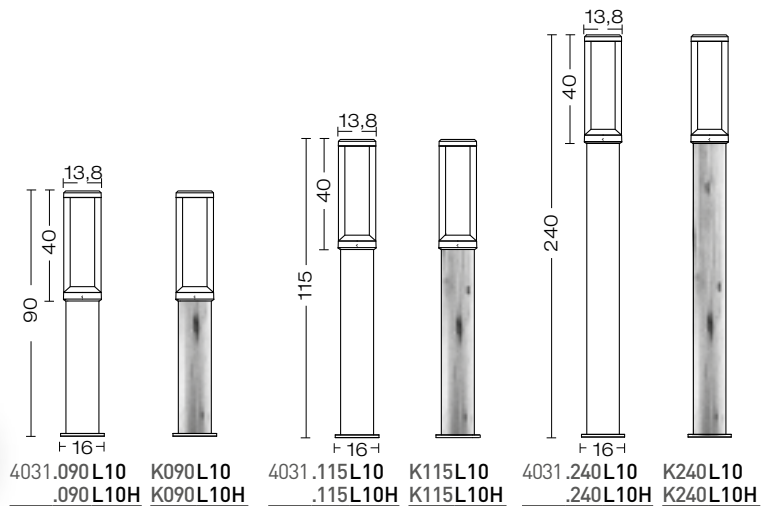
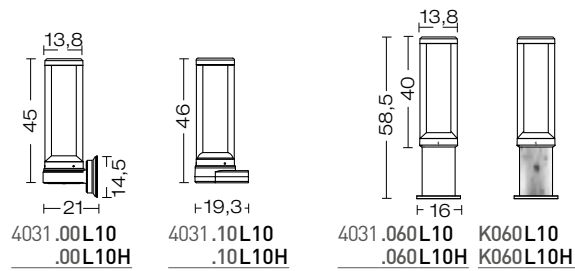
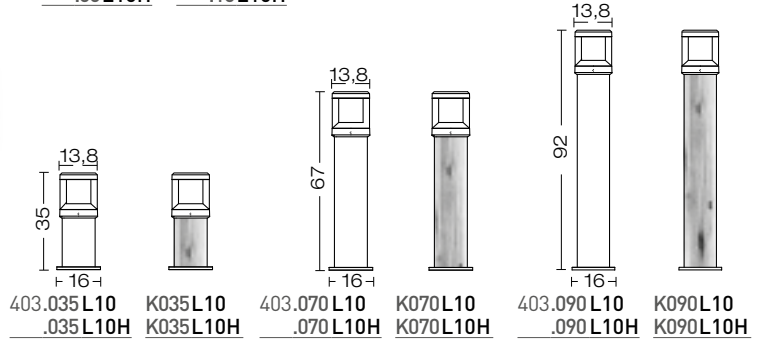
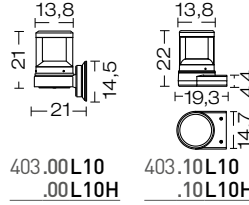

FOR TECHNICAL DETAILS VISIT  
[www.landa.it](http://www.landa.it)

IP65  
code 403.00 - 4031.00 IP64  
403.10 - 4031.10

960°

FINISHING



dettagli / details  
/ details detalles  
/ details:  
p.A58 - A59



## Wood that isn't wood

Processo produttivo non inquinante  
Production process is not polluting  
C'est un procédé productif non polluant  
Proceso productivo no contaminante  
Umweltfreundlicher Herstellungsprozess



ELECTRIFICATION

**LED**

powered by  
Citizen Electronics® LED  
Transformer included

dettagli / details / details / detalles / details:  
p.A52-A53

Energy efficiency classes

**L10**  
LED 10 W  
5000K  
1300LM  
Ra80

**L10H**  
LED 10 W  
3000K  
1100LM  
Ra80



polos

Projectors

Recessed

NEW

Contemporary

Traditional

CONTEMPORARY



121



Accessories on request:



code 0404M004  
Single connection IP68



code 0404M003  
Loop in loop out IP68

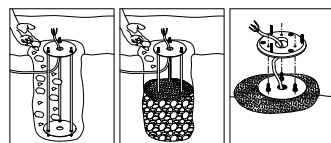

Root Mounting Kit code 00A405

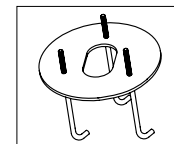
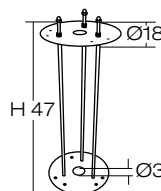

code 00A405.01P  
Anchor Bolt





# polos

art.  
**403**  
**4031**

design **Ufficio Tecnico Landa**

**OHIM:**  
European Patent No.  
000508106-0002

example code:  
| art. | finishing | size | electrification | colour |  
403 | • | 090 | E27 | all |  
COUNTRY example code:  
| art. | finishing | size | electrification | colour |  
403 | **K** | 090 | E27 | all |



corpo alluminio pressofuso  
e estruso  
body in die casting  
and extruded aluminium  
corps en aluminium moulé  
sous pression et extrudé  
cuerpo aluminio inyectado  
y extrusionado  
Körper aus Aluminium-  
Druckguss

diffusore policarbonato  
trasparente  
diffuser transparent  
polycarbonate  
diffuser polycarbonate  
transparent  
difusor policarbonato  
transparente  
Diffuser Polykarbonat klar

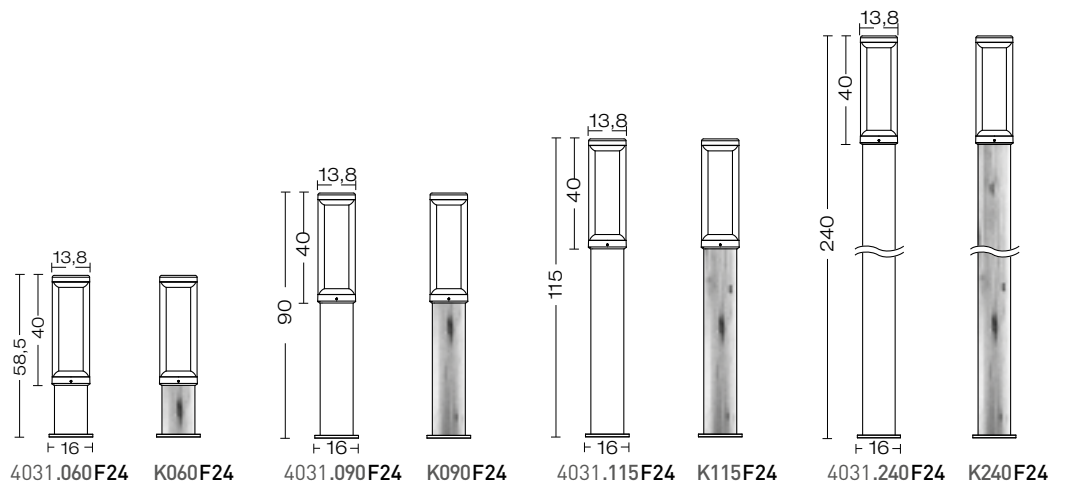
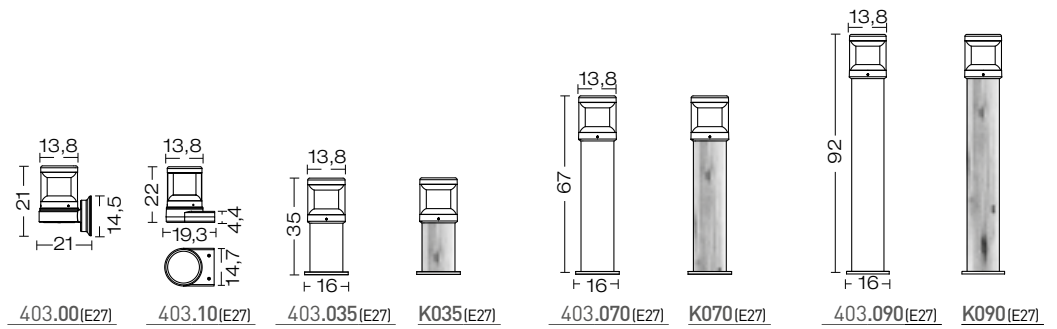

FOR TECHNICAL DETAILS VISIT  
[www.landa.it](http://www.landa.it)

IP65

code 403.00 – 403.10 IP64

96°

**FINISHING**

**K**  
dettagli / details  
/ details detalles  
/ details:  
p.A58 - A59



code 403K....

**Wood that isn't wood**

Processo produttivo non inquinante  
Production process is not polluting  
C'est un procédé productif non polluant  
Proceso productivo no contaminante  
Umweltfreundlicher Herstellungsprozess



**ELECTRIFICATION**

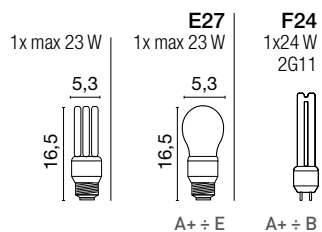

Energy efficiency classes

polos

Projectors

Recessed

NEW

Contemporary

Traditional

CONTEMPORARY



123



Thanks to Franssen Verlichting - NL



Thanks to Franssen Verlichting - NL



Accessories on request:



code 0404M004  
Single connection IP68



code 0404M003  
Loop in loop out IP68

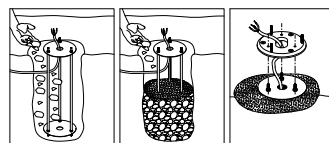

Root Mounting Kit code 00A405

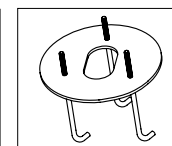
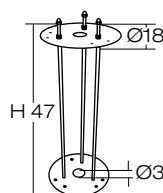

code 00A405.01P  
Anchor Bolt



serie/series

luna

**LED**

powered by:  
Vossloh 13W  
AC direct connection  
220/240V  
Transformer not required

example code:  
art. LED finishing size colour  
440 L12 H K 090 P1 ngg

art.  
**440**

design **Duse & Righetto**

progetto **Meta-Distrettuale Numa**

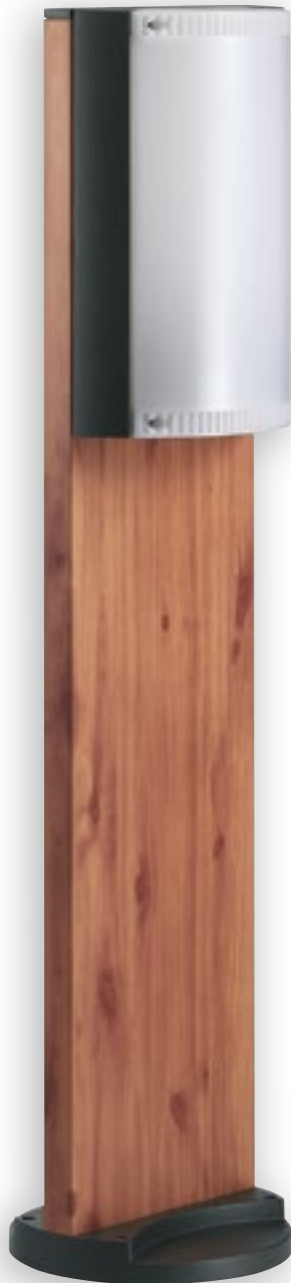

corpo alluminio pressofuso  
e estruso  
body in die casting  
and extruded aluminium  
corps en aluminium moulé  
sous pression et extrudé  
cuerpo aluminio inyectado  
y extrusionado  
Körper aus Aluminium-  
Druckguss

diffusore policarbonato opale  
diffuser polycarbonate opal  
diffuser polycarbonate opale  
difusor policarbonato ópalo  
Diffuser Polykarbonat opal

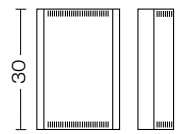

440L12N  
L12H

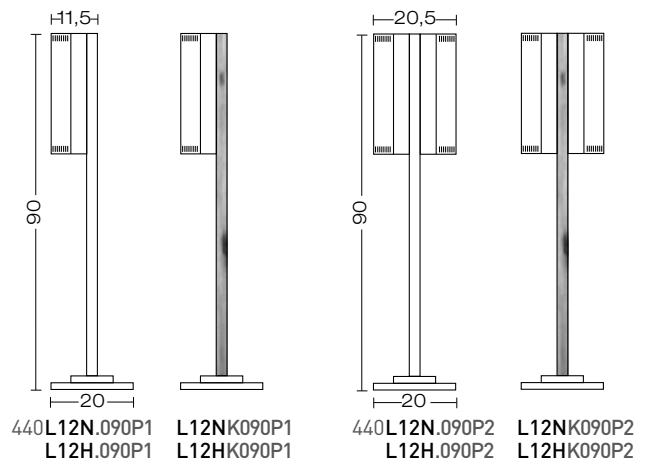
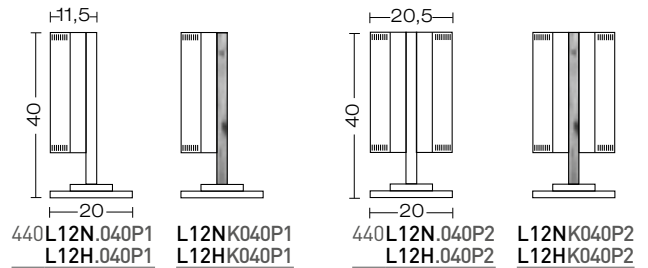

FOR TECHNICAL DETAILS VISIT  
[www.landa.it](http://www.landa.it)

IP54 85°

**FINISHING**

**K**  
dettagli / details  
/ details detalles  
/ details:  
p.A58 - A59



code 440K....

**Wood that isn't wood**

Processo produttivo non inquinante  
Production process is not polluting  
C'est un procédé productif non polluant  
Proceso productivo no contaminante  
Umweltfreundlicher Herstellungsprozess

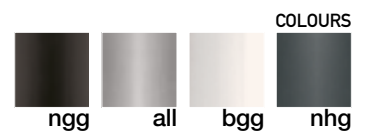

**ELECTRIFICATION**

**LED**

dettagli / details / details  
detales / details:  
p.A54 - A55

Energy efficiency classes

**P1L12N**  
LED 1x13W  
4000K  
1160LM  
Ra80



A++ ÷ A

**P1L12H**  
LED 1x13W  
3000K  
1140LM  
Ra80



A++ ÷ A

**P2L12N**  
LED 2x13W  
4000K  
2x1160LM  
Ra80



A++ ÷ A

**P2L12H**  
LED 2x13W  
3000K  
2x1140LM  
Ra80



A++ ÷ A

luna

Projectors

Recessed

Contemporary

Traditional



CONTEMPORARY

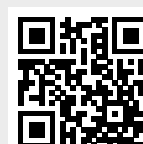

# luna

art.  
**440**

design **Duse & Righetto**

progetto **Meta-Distrettuale Numa**

example code:				
art.	electrification	finishing	size	colour
440	E27	.	040 P1	nhg
COUNTRY example code:				
art.	electrification	finishing	size	colour
440	E27	K	040 P1	nhg

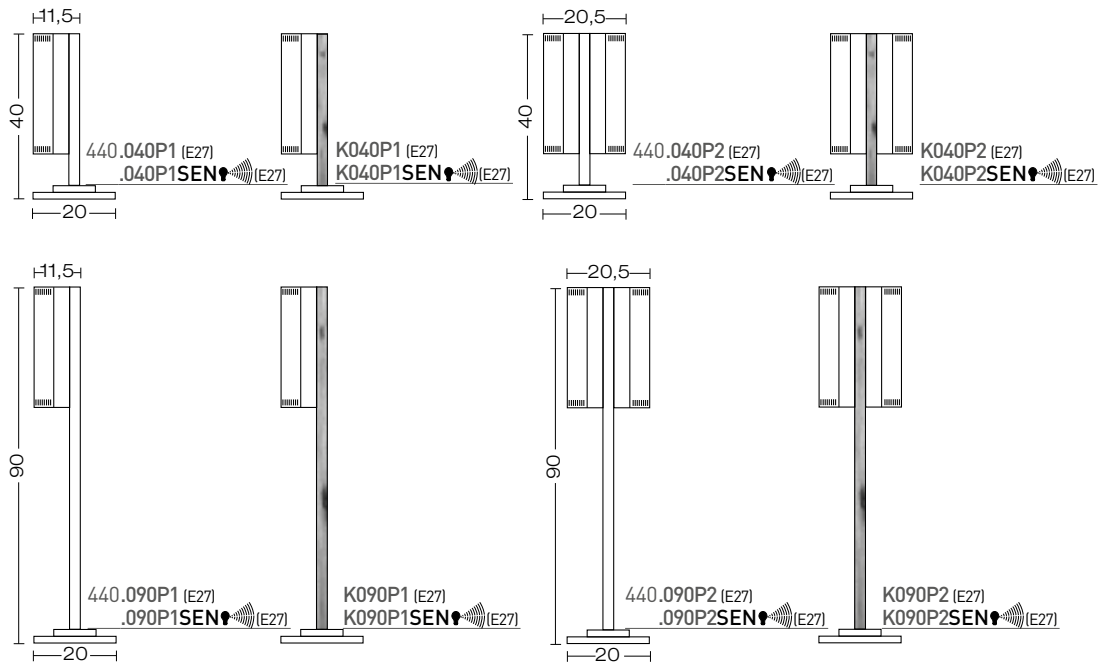
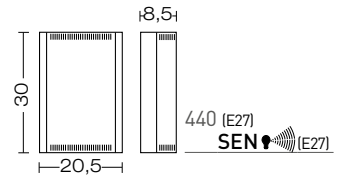

corpo alluminio pressofuso e estruso  
body in die casting and extruded aluminium  
corps en aluminium moulé sous pression et extrudé  
cuerpo aluminio inyectado y extrusionado  
Körper aus Aluminium-Druckguss

diffusore policarbonato opale  
diffuser polycarbonate opal  
diffuser polycarbonate opale  
difusor policarbonato ópalo  
Diffuser Polykarbonat opal

126 | CONTEMPORARY

FOR TECHNICAL DETAILS VISIT [www.landa.it](http://www.landa.it)

IP54 850°

### FINISHING



### Wood that isn't wood

Processo produttivo non inquinante  
Production process is not polluting  
C'est un procédé productif non polluant  
Proceso productivo no contaminante  
Umweltfreundlicher Herstellungsprozess

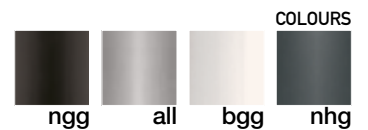

### ELECTRIFICATION

## sensor



dettagli / details / details / details: p.A56

1x max 75W (P2) 2x max 75W



1x23W (P2) 2x23W

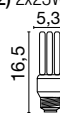

E27

1x20W (P2) 2x20W

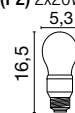

A+ ÷ E

Energy efficiency classes

luna

Projectors

Recessed

Contemporary

Traditional

CONTEMPORARY



ENERGY  
SAVING



serie/series

# titano INOX

# LED

powered by  
Citizen Electronics® LED  
Transformer included

example code:

art.	finishing	size	LED	○
822	K	100	L10	H

COUNTRY example code:

art.	finishing	size	LED	○
822	K	100	L10	H

art.  
**822**

design **Ufficio Tecnico Landa**

**OHIM:**  
European Patent No.  
000508106-0002



128 | CONTEMPORARY

corpo acciaio inox AISI 316L  
body stainless steel AISI 316L  
corps acier inoxydable  
AISI 316L  
cuerpo acero inox AISI 316L  
Körper Edelstahl AISI 316L

diffusore policarbonato  
trasparente  
diffuser transparent  
polycarbonate  
diffuser polycarbonate  
transparent  
difusor policarbonato  
transparente  
Diffuser Polykarbonat klar



**stainless steel CLEANER**  
code **OODEC**  
details: **p.A62**

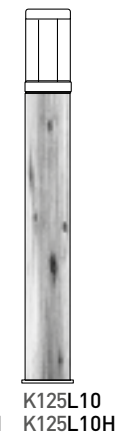
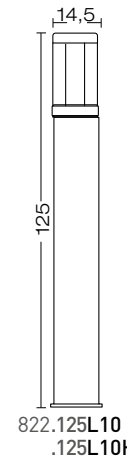
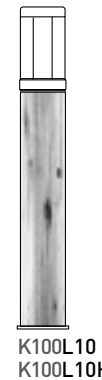
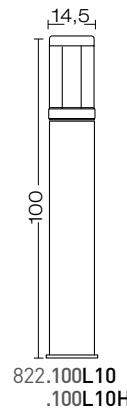
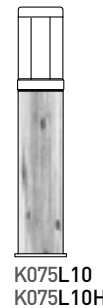
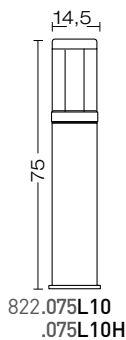
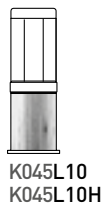
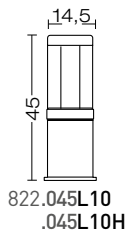
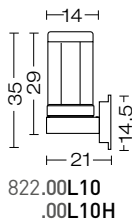

FOR TECHNICAL DETAILS VISIT  
[www.landa.it](http://www.landa.it)

IP65  
code 822.00IP43

960°

FINISHING



K

dettagli / details  
/ details detalles  
/ details:  
p.A58 - A59



code 822K....

## Wood that isn't wood

Processo produttivo non inquinante  
Production process is not polluting  
C'est un procédé productif non polluant  
Proceso productivo no contaminante  
Umweltfreundlicher Herstellungsprozess



code 822.....



ELECTRIFICATION

# LED

dettagli /  
details / details  
detales / details:  
p.A54 - A55

Energy efficiency classes

**L10**  
LED 10 W  
5000K  
1300LM  
Ra80



A++ ÷ A

**L10H**  
LED 10 W  
3000K  
1100LM  
Ra80



A++ ÷ A

titano INOX



Projectors

Recessed

Contemporary

Traditional

CONTEMPORARY



129



Accessories on request:



code 0404M004  
Single connection IP68



code 0404M003  
Loop in loop out IP68

Accessories not available for: 822.00

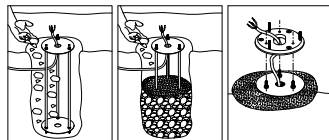

Root Mounting Kit code 00A405

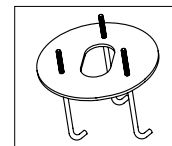
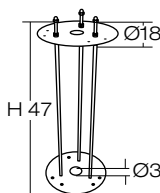

code 00A400.01P  
Anchor Bolt





# titano INOX

example code:  
 | art. | finishing | size | electrification |  
 822 | K | 100 | E27  
 COUNTRY example code:  
 | art. | finishing | size | electrification |  
 822 | K | 100 | E27

art.  
**822**

design **Ufficio Tecnico Landa**

**OHIM:**  
**European Patent No.**  
 000508106-0002



corpo acciaio inox AISI 316L  
 body stainless steel AISI 316L  
 corps acier inoxydable  
 AISI 316L  
 cuerpo acero inox AISI 316L  
 Körper Edelstahl AISI 316L

diffusore policarbonato  
 trasparente  
 diffuser transparent  
 polycarbonate  
 diffuser polycarbonate  
 transparent  
 difusor policarbonato  
 transparente  
 Diffuser Polykarbonat klar



**stainless steel CLEANER**  
 code **OODEC**  
 details: **p.A62**

FOR TECHNICAL DETAILS VISIT  
[www.landa.it](http://www.landa.it)

IP65  
 code 822.00 IP43

960°

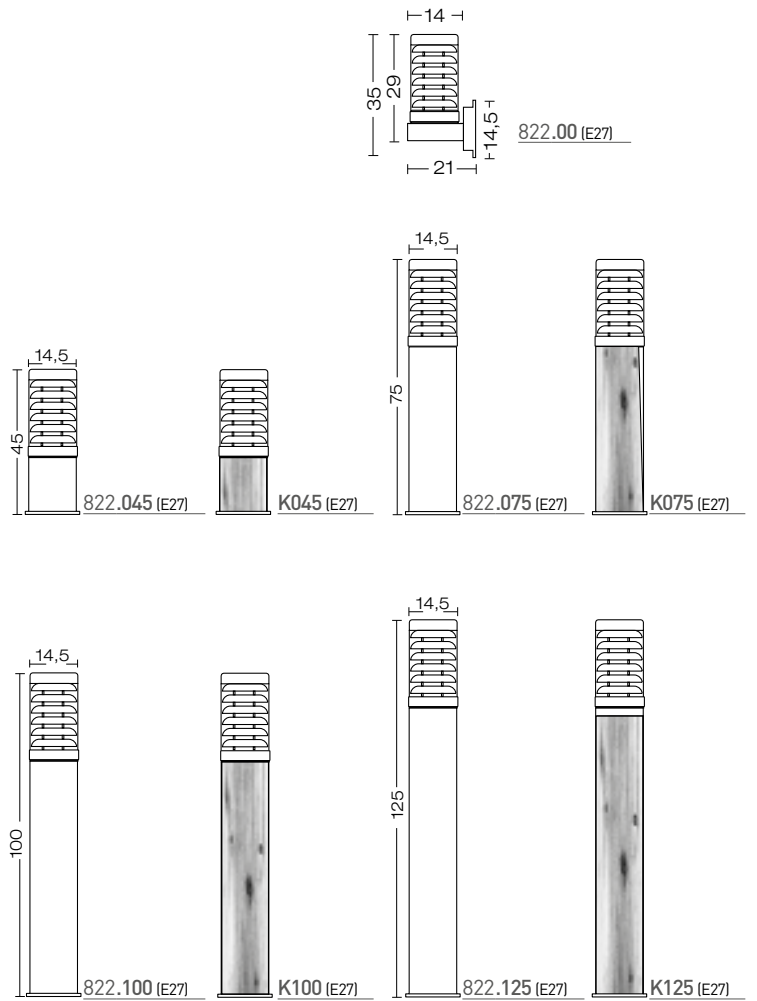

**FINISHING**

**K**  
 dettagli / details  
 / details detalles  
 / details:  
 p.A58 - A59



code **822K**....

**Wood that isn't wood**

Processo produttivo non inquinante  
 Production process is not polluting  
 C'est un procédé productif non polluant  
 Proceso productivo no contaminante  
 Umweltfreundlicher Herstellungsprozess



code **822**.....



**ELECTRIFICATION**

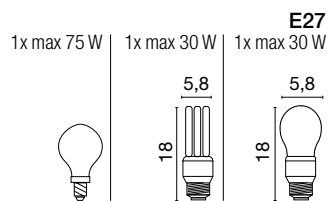

Energy efficiency classes

A+ ÷ E

titano INOX

Projectors

Recessed

Contemporary

Traditional

CONTEMPORARY



131

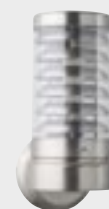

Accessories on request:



code 0404M004  
Single connection IP68



code 0404M003  
Loop in loop out IP68

Accessories not available for: 822.00

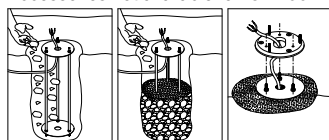

Root Mounting Kit code 00A405

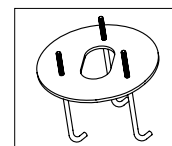
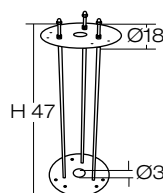

code 00A400.01P  
Anchor Bolt

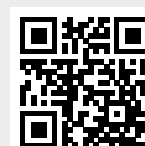

# orion

# LED

powered by  
Citizen Electronics® LED  
Transformer included

example code:  
| art. | finishing | size | LED | colour |  
400 | K | 045 | L14 | H | oxi  
COUNTRY example code:  
| art. | finishing | size | electrification | colour |  
400 | K | 045 | PL18 | nhg

art.  
**400**

design Ufficio Tecnico Landa

132 | CONTEMPORARY

corpo alluminio pressofuso  
e estruso  
body in die casting  
and extruded aluminium  
corps en aluminium moulé  
sous pression et extrudé  
cuerpo aluminio inyectado  
y extrusionado  
Körper aus Aluminium-  
Druckguss

diffusore policarbonato opale  
diffuser polycarbonate opal  
diffuser polycarbonate opale  
difusor policarbonato ópalo  
Diffuser Polykarbonat opal

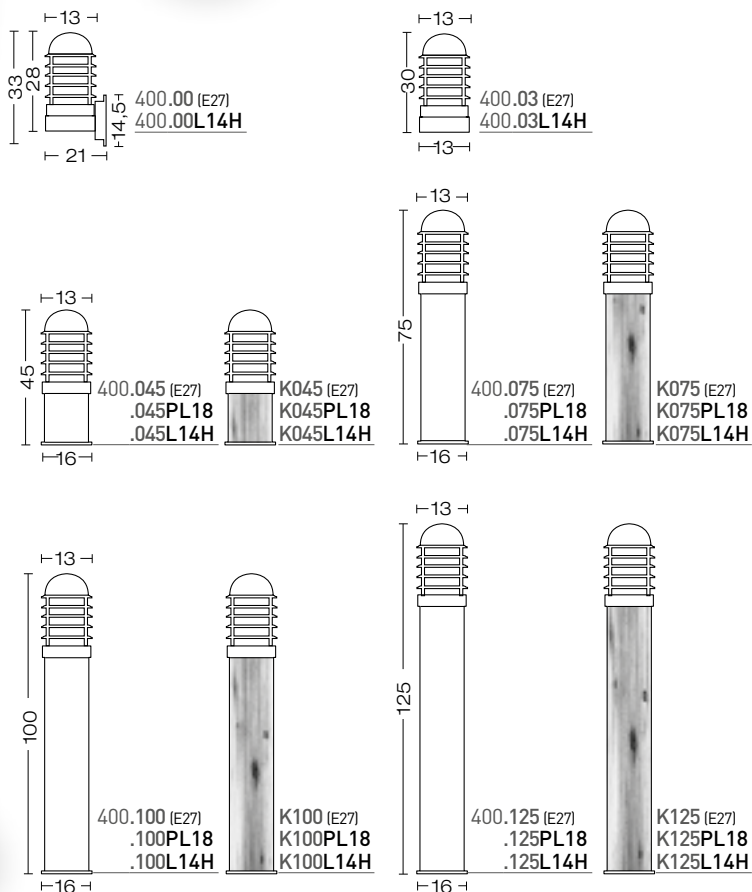

FOR TECHNICAL DETAILS VISIT  
[www.landa.it](http://www.landa.it)

IP44

850°

### FINISHING



dettagli / details  
/ details detalles  
/ details:

p.A58 - A59

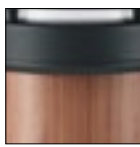

code 400K....

### Wood that isn't wood

Processo produttivo non inquinante  
Production process is not polluting  
C'est un procédé productif non polluant  
Proceso productivo no contaminante  
Umweltfreundlicher Herstellungsprozess

### COLOURS



### ELECTRIFICATION

# LED

dettagli / details  
/ details detalles  
/ details:

p.A54 - A55

Energy efficiency classes

**L14H**  
LED 14 W  
3000K  
1820LM  
Ra80

1x max  
100 W



A++ ÷ A

1x max  
23 W  
5,3



A+ ÷ E

**E27**  
1x max  
20 W  
5,3



**PL18**  
1x18 W  
G24 d-2



A+ ÷ B

orion

Projectors

Recessed

NEW

Contemporary

Traditional

CONTEMPORARY



133



Thanks to Ansell Lighting - UK

Accessories on request:



code 0404M004  
Single connection IP68



code 0404M003  
Loop in loop out IP68

Accessories not available for: 400.00 – 400.03

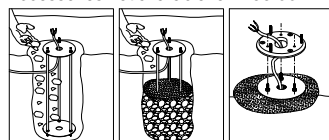

Root Mounting Kit code 00A400

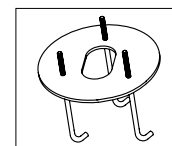
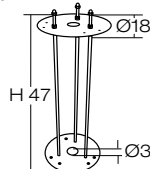

code 00A400.01P  
Anchor Bolt



serie/series

# orion

# LED

powered by  
Citizen Electronics® LED  
Transformer included

example code:

art.	finishing	size	LED	colour
401	K	075	L14 H	oxi

COUNTRY example code:

art.	finishing	size	electrification	colour
401	K	075	PL18	nhg

art.  
**401**

design **Ufficio Tecnico Landa**

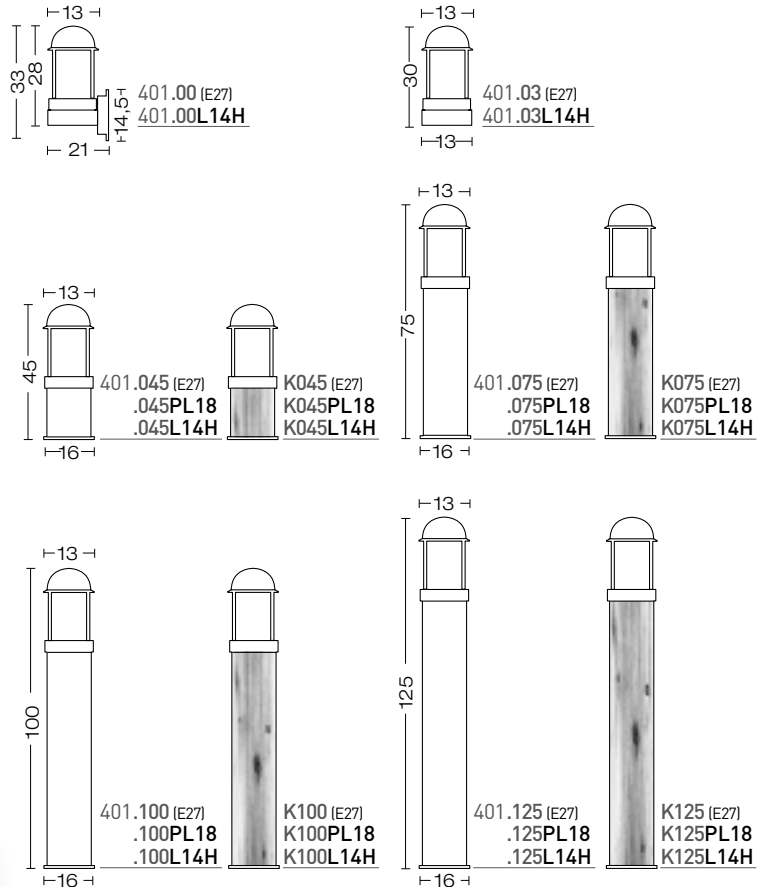

corpo alluminio pressofuso  
e estruso  
body in die casting  
and extruded aluminium  
corps en aluminium moulé  
sous pression et extrudé  
cuerpo aluminio inyectado  
y extrusionado  
Körper aus Aluminium-  
Druckguss

diffusore policarbonato opale  
diffuser polycarbonate opal  
diffuser polycarbonate opale  
difusor policarbonato ópalo  
Diffuser Polykarbonat opal

134 | CONTEMPORARY

FOR TECHNICAL DETAILS VISIT  
[www.landa.it](http://www.landa.it)

IP44

850°

### FINISHING

**K**  
dettagli / details  
/ details detalles  
/ details:  
p.A58 - A59



code 401K....

### Wood that isn't wood

Processo produttivo non inquinante  
Production process is not polluting  
C'est un procédé productif non polluant  
Proceso productivo no contaminante  
Umweltfreundlicher Herstellungsprozess

### COLOURS



### ELECTRIFICATION

# LED

dettagli / details  
/ details detalles  
/ details:  
p.A54 - A55

Energy efficiency classes

**L14H**  
LED 14 W  
3000K  
1820LM  
Ra80

1x max  
100 W



A++ ÷ A

1x max  
23 W  
5,3



A+ ÷ E

**E27**  
1x max  
20 W  
5,3



**PL18**  
1x18 W  
G24 d-2



A+ ÷ B

orion

Projectors

Recessed

NEW

Contemporary

Traditional

CONTEMPORARY



Thanks to Ansell Lighting - UK



Accessories on request:



code 0404M004  
Single connection IP68



code 0404M003  
Loop in loop out IP68

Accessories not available for: 401.00 – 401.03

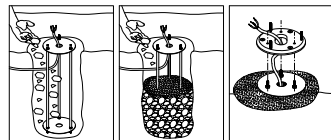

Root Mounting Kit code 00A400

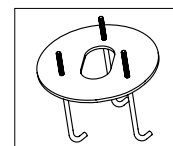
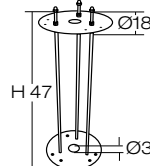

code 00A400.01P  
Anchor Bolt



# orion INOX

example code:  
 | art. | finishing | size | electrification |  
 800 · 075 E27  
 COUNTRY example code:  
 | art. | finishing | size | electrification |  
 800 K 075 E27

art.  
**800**

design **A. Dolcetti**

CONTEMPORARY

136 corpo acciaio inox AISI 316L  
 body stainless steel AISI 316L  
 corps acier inoxydable  
 AISI 316L  
 cuerpo acero inox AISI 316L  
 Körper Edelstahl AISI 316L

diffusore policarbonato opale  
 diffuser polycarbonate opal  
 diffusor polycarbonato opale  
 difusor polycarbonato ópalo  
 Diffuser Polykarbonat opal



stainless steel **CLEANER**  
 code **OODEC**  
 details: **p.A62**

FOR TECHNICAL DETAILS VISIT  
[www.landa.it](http://www.landa.it)

IP44

850°

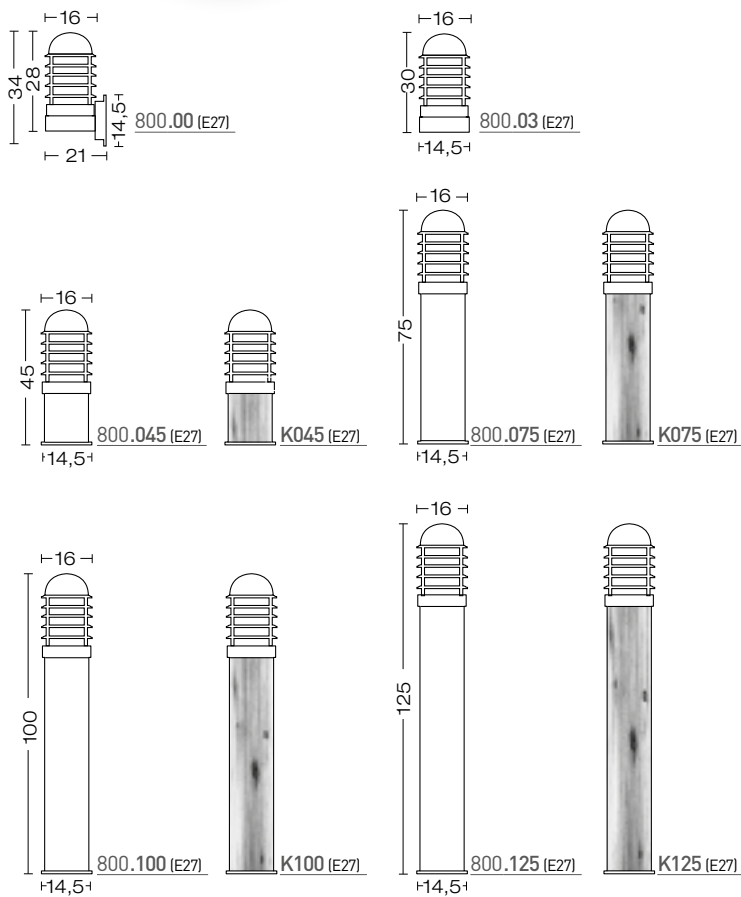

**FINISHING**

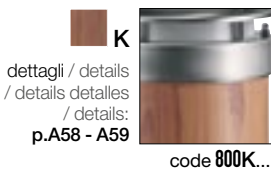

**Wood that isn't wood**

Processo produttivo non inquinante  
 Production process is not polluting  
 C'est un procédé productif non polluant  
 Proceso productivo no contaminante  
 Umweltfreundlicher Herstellungsprozess



**ELECTRIFICATION**

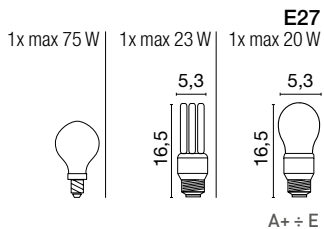

Energy efficiency classes

A+ ÷ E

orion INOX

Projectors

Recessed

Contemporary

Traditional

CONTEMPORARY



Thanks to Ansell Lighting - UK



Accessories on request:



code 0404M004  
Single connection IP68



code 0404M003  
Loop in loop out IP68

Accessories not available for: 800.00 – 800.03

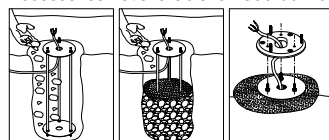

Root Mounting Kit code 00A400

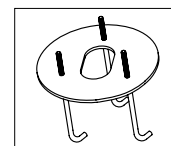
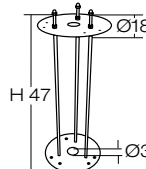

code 00A400.01P  
Anchor Bolt





# orion INOX

example code:  
 | art. | finishing | size | electrification |  
 801    •    100    E27  
 COUNTRY example code:  
 | art. | finishing | size | electrification |  
 801    K    100    E27

art.  
**801**

design **A. Dolcetti**

CONTEMPORARY

138 corpo acciaio inox AISI 316L  
 body stainless steel AISI 316L  
 corps acier inoxydable  
 AISI 316L  
 cuerpo acero inox AISI 316L  
 Körper Edelstahl AISI 316L

diffusore policarbonato opale  
 diffuser polycarbonate opal  
 diffusor polycarbonato opale  
 difusor policarbonato ópalo  
 Diffuser Polykarbonat opal



stainless steel **CLEANER**  
 code **OODEC**  
 details: **p.A62**

FOR TECHNICAL DETAILS VISIT  
[www.landa.it](http://www.landa.it)

IP44

850°

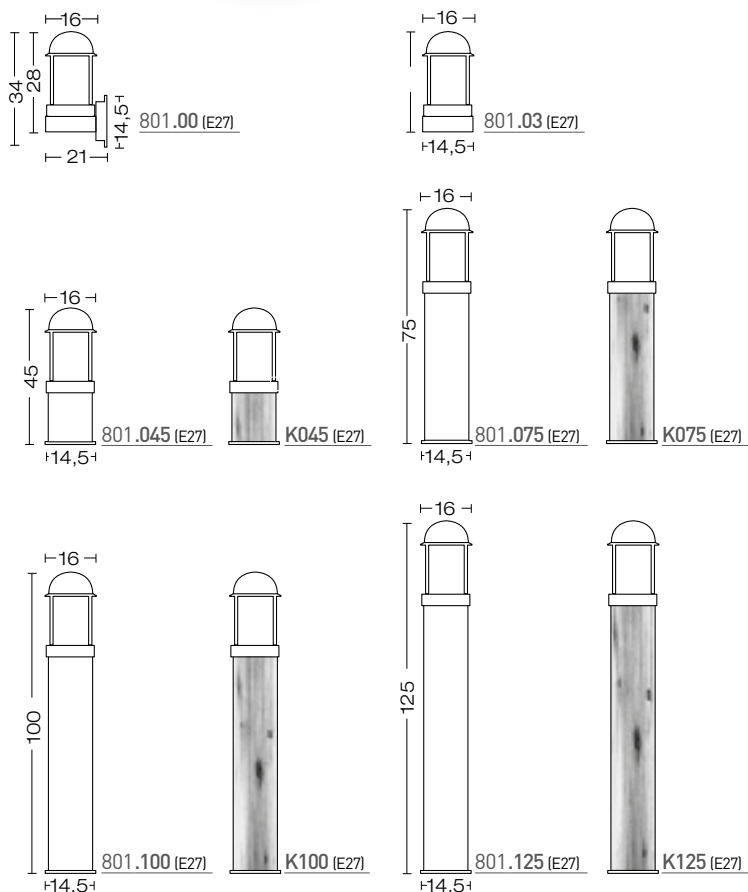

**FINISHING**



**Wood that isn't wood**

Processo produttivo non inquinante  
 Production process is not polluting  
 C'est un procédé productif non polluant  
 Proceso productivo no contaminante  
 Umweltfreundlicher Herstellungsprozess

dettagli / details  
 / details detalles  
 / details:  
 p.A58 - A59

code **801K....**



code **801.....**



**ELECTRIFICATION**

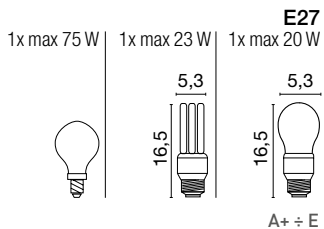

Energy efficiency classes

orion INOX

Projectors

Recessed

Contemporary

Traditional

CONTEMPORARY



Thanks to Ansell Lighting - UK



Accessories on request:



code 0404M004  
Single connection IP68



code 0404M003  
Loop in loop out IP68

Accessories not available for: 801.00 - 801.03

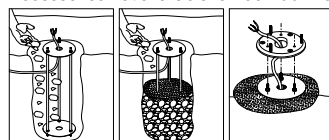

Root Mounting Kit code 00A400

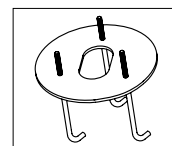
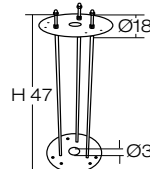

code 00A400.01P  
Anchor Bolt



# urano

art.  
**810**

design **Ufficio Tecnico Landa**

example code:  
| art. | electrification | finishing | size |  
810 E27 • 20  
COUNTRY example code:  
| art. | electrification | finishing | size |  
810 E27 K 20



140 | CONTEMPORARY

corpo acciaio inox AISI 316L  
body stainless steel AISI 316L  
corps acier inoxydable AISI 316L  
cuerpo acero inox AISI 316L  
Körper Edelstahl AISI 316L

diffusore policarbonato  
trasparente  
diffuser transparent  
polycarbonate  
diffuser polycarbonate  
transparent  
difusor policarbonato  
transparente  
Diffuser Polykarbonat klar



stainless steel **CLEANER**  
code **OODEC**  
details: **p.A62**

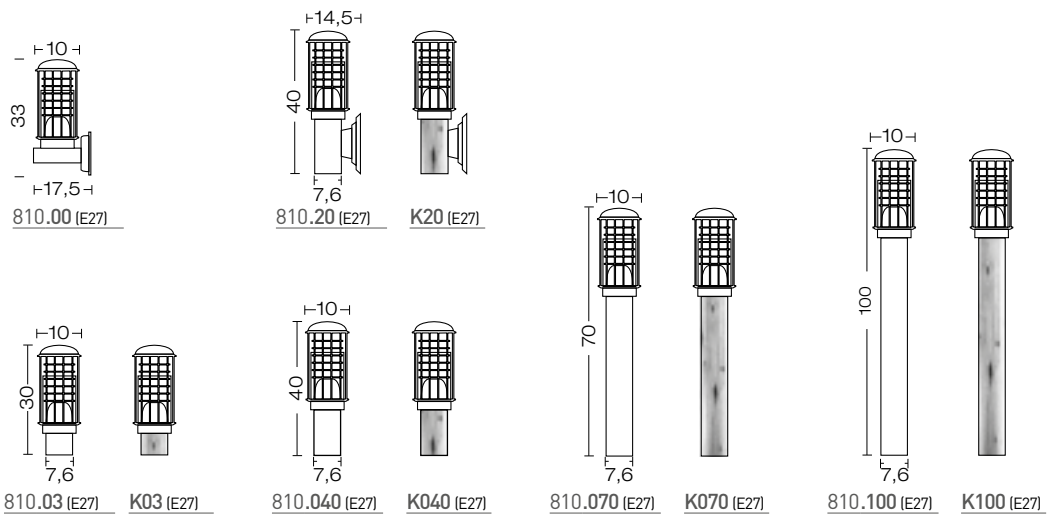

FOR TECHNICAL DETAILS VISIT  
[www.landa.it](http://www.landa.it)

IP44

code 810.00 IP43

960°

### FINISHING

**K**  
dettagli / details  
/ details detalles  
/ details:  
p.A58 - A59



code 810K....

### Wood that isn't wood

Processo produttivo non inquinante  
Production process is not polluting  
C'est un procédé productif non polluant  
Proceso productivo no contaminante  
Umweltfreundlicher Herstellungsprozess



code 810.....



### ELECTRIFICATION

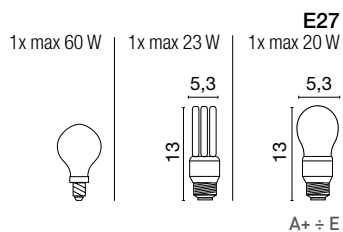

Accessories on request:



code **O404M004**  
Single connection IP68

Energy efficiency classes

urano

Projectors

Recessed

Contemporary

Traditional

CONTEMPORARY



Thanks to Ansell Lighting - UK



# colonna 52

example code:  
 | art. | electrification | finishing | size |  
 430 | E14 | . | 070 |  
 INOX example code:  
 | art. | electrification | finishing | size |  
 9200 | E14 | . | 070 |

art.  
**430**  
**9200**

design **Ufficio Tecnico Landa**

CONTEMPORARY  
 142



corpo alluminio estruso  
 body extruded aluminium  
 corps en aluminium extrudé  
 cuerpo aluminio extrusionado  
 Körper Aluminium

COLOURS



nhg

430

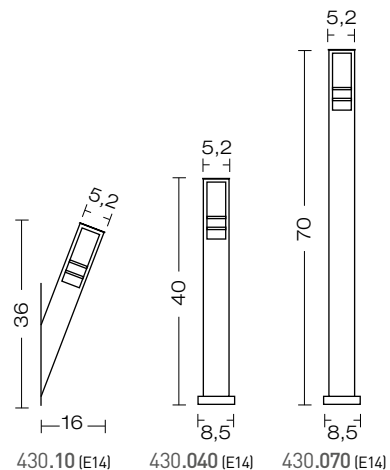

corpo acciaio inox AISI 316L  
 body stainless steel AISI 316L  
 corps acier inoxydable AISI 316L  
 cuerpo acero inox AISI 316L  
 Körper Edelstahl AISI 316L



9200

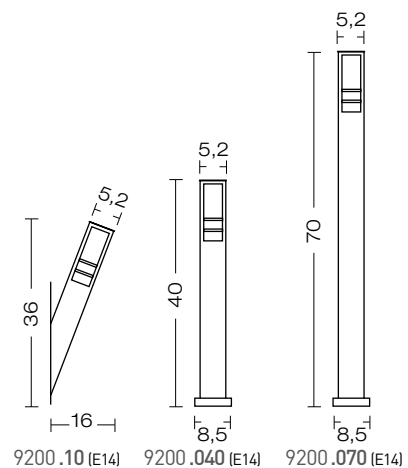

diffusore policarbonato  
 diffuser polycarbonate  
 diffusor polycarbonate  
 difusor policarbonato  
 Diffuser Polykarbonat



stainless steel **CLEANER**  
 code OODEC  
 details: p.A62

FOR TECHNICAL DETAILS VISIT  
[www.landa.it](http://www.landa.it)

IP44

850°

ELECTRIFICATION

**E14**  
 1x max 11 W



A+ ÷ E

Energy efficiency classes

## colonna 52

Projectors

Recessed

Contemporary

Traditional

CONTEMPORARY



143



# colonna 76

example code:  

art.	electrification	finishing	size
435	E27	.	055

 INOX example code:  

art.	electrification	finishing	size
9240	E27	.	055

art.  
**435**  
**9240**

design Ufficio Tecnico Landa

144 | CONTEMPORARY



corpo alluminio estruso  
 body extruded aluminium  
 corps en aluminium extrudé  
 cuerpo aluminio extrusionado  
 Körper Aluminium

**COLOURS**



**nhg**

435

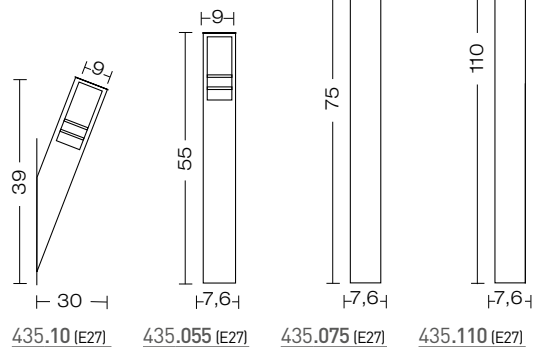

corpo acciaio inox AISI 316L  
 body stainless steel AISI 316L  
 corps acier inoxydable AISI 316L  
 cuerpo acero inox AISI 316L  
 Körper Edelstahl AISI 316L



9240

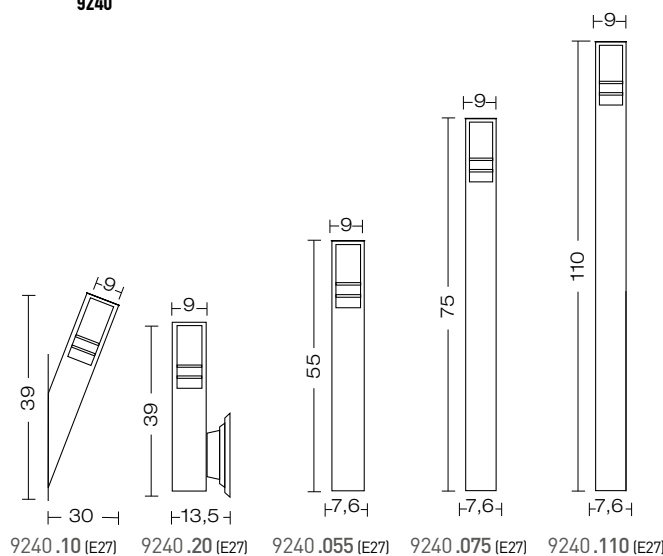

diffusore policarbonato opale  
 diffuser polycarbonate opal  
 diffusor polycarbonato opale  
 difusor policarbonato ópalo  
 Diffuser Polykarbonat opal



stainless steel **CLEANER**  
 code **OODEC**  
 details: **p.A62**

FOR TECHNICAL DETAILS VISIT  
[www.landa.it](http://www.landa.it)

IP44

code 435.10 - 9240.10 IP43

850°

ELECTRIFICATION

**E27**  
 1x max 23 W

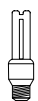

A+ ÷ E

Accessories on request:



code **O404M004**  
 Single connection IP68



code **O404M003**  
 Loop in loop out IP68

Energy efficiency classes

## colonna 76

Projectors

Recessed

# NEW

Contemporary

Traditional

CONTEMPORARY



145



Thanks to Franssen Verlichting - NL





serie/series

# lampara INOX

art.	electrification	finishing	size
9500	E27	.	PA4T1

art.  
**9500**

design **Ufficio Tecnico Landa**



146 | CONTEMPORARY

corpo acciaio inox AISI 316L  
body stainless steel  
AISI 316L  
corps acier inoxydable AISI  
316L  
cuerpo acero inox AISI 316L  
Körper Edelstahl AISI 316L

diffusore policarbonato  
trasparente  
diffuser transparent  
polycarbonate  
diffuser polycarbonate  
transparent  
difusor policarbonato  
transparente  
Diffuser Polykarbonat klar



**stainless steel CLEANER**  
code **OODEC**  
details: **p.A62**

FOR TECHNICAL DETAILS VISIT  
[www.landa.it](http://www.landa.it)

IP44

850°

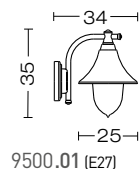

9500.01 (E27)

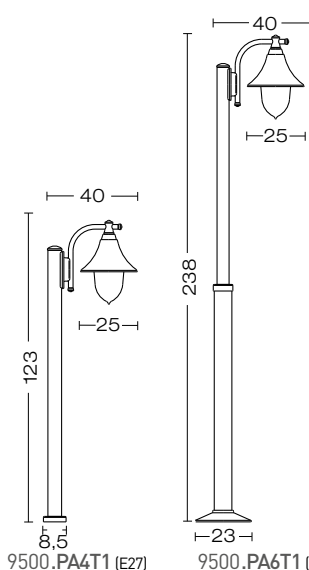

9500.PA4T1 (E27)

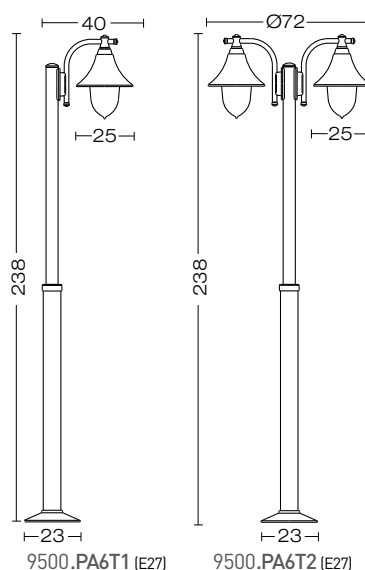

9500.PA6T1 (E27)

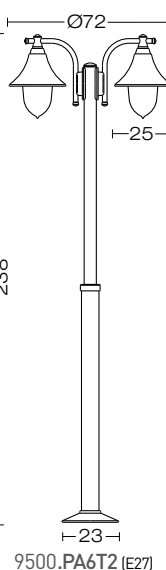

9500.PA6T2 (E27)



## ELECTRIFICATION

1x max 100 W  
2x max 100 W



1x max 23 W  
2x max 23 W

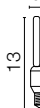

**E27**  
1x max 20 W  
2x max 20 W



A+ ÷ E

## Accessories on request:

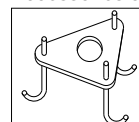

code **OOAPA6**  
Anchor Bolt

available for:  
9500.PA6T1  
9500.PA6T2

Energy efficiency classes

lampara INOX

Projectors

Recessed

Contemporary

Traditional

CONTEMPORARY



147



Thanks to Pipbrothers - BG



serie/series

# cervinia

## LED 13W

powered by  
Vossloh 13W  
AC direct connection  
220/240V  
Transformer not required

example code:  
| art. | LED |  | colour |  
9008 LV12 H all  
example code:  
| art. | electrification | colour |  
9008 E27 all

art.  
**9008**

design Duse & Righetto



CONTEMPORARY

148

corpo alluminio pressofuso  
body in die casting aluminium  
corps en aluminium moulé  
sous pression  
cuerpo aluminio inyectado  
Körper aus Aluminium-  
Druckguss

diffusore policarbonato opale  
diffuser polycarbonate opal  
diffuser polycarbonate opale  
difusor policarbonato ópalo  
Diffuser Polykarbonat opal

## LED 13W

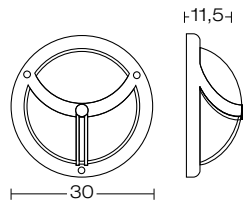
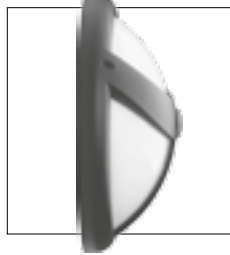

9008 LV12N  
LV12H  
LV12N SEN   
LV12H SEN 

FOR TECHNICAL DETAILS VISIT  
[www.landa.it](http://www.landa.it)

IP54

850°

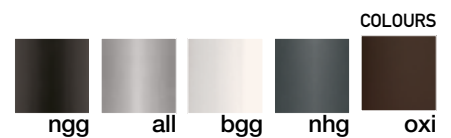

ELECTRIFICATION

## LED

dettagli /  
details / details  
detalles / details:  
p.A54 - A55





Energy efficiency classes

## sensor



dettagli  
details  
detalles  
details:  
p.A56

Transformer not required

LV12N	LV12H	LV12NSEN	LV12HSEN
LED 13 W	LED 13 W	LED 13 W	LED 13 W
4000K	3000K	4000K	3000K
1160LM	1140LM	1160LM	1140LM
Ra80	Ra80	Ra80	Ra80
			
A+++ ÷ A	A+++ ÷ A	A+++ ÷ A	A+++ ÷ A

cervinia



Projectors

Recessed

Contemporary

Traditional

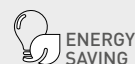

CONTEMPORARY

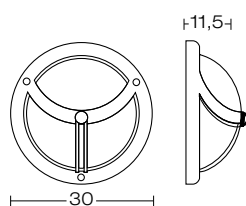
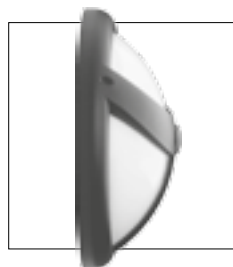

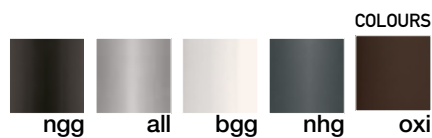

9008 (E27)  
SEN  (E27)



**sensor**

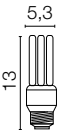

dettagli  
details  
détails  
details:  
p.A56

1x max 60 W	1x max 20 W	E27 1x max 16 W
		
	13	13
	5,3	5,3
		A+ ÷ E



# cervinia

example code:  
 | art. | electrification | colour |  
 9002 | E27 | ngr

art.  
**9002**  
**9006**

design Ufficio Tecnico Landa



150 | CONTEMPORARY

corpo alluminio  
 body aluminium  
 corps en aluminium  
 cuerpo aluminio  
 Körper aus Aluminium

diffusore policarbonato opale  
 diffuser polycarbonate opal  
 diffusor polycarbonate opale  
 difusor policarbonato ópalo  
 Diffuser Polykarbonat opal



9002

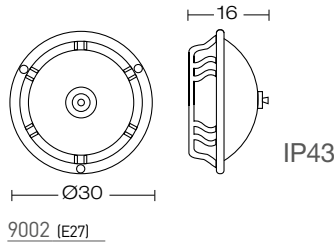

9002 (E27)



9006

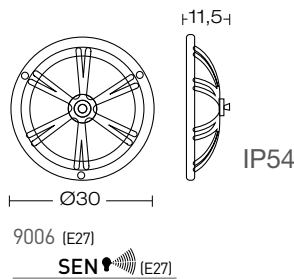

9006 (E27)

SEN  (E27)

FOR TECHNICAL DETAILS VISIT  
[www.landa.it](http://www.landa.it)

850°

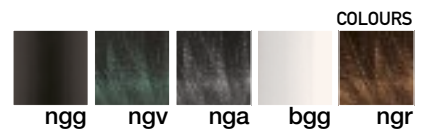

ELECTRIFICATION

E27  
 1x max 60 W



A+ ÷ E

**sensor**



dettagli  
 details  
 detalles  
 details:  
 p.A56

1x max 60 W



1x max 20 W

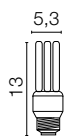

E27  
 1x max 16 W

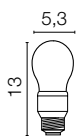

A+ ÷ E

Energy efficiency classes

cervinia

Projectors

Recessed

Contemporary

Traditional

CONTEMPORARY



Thanks to Martin Fukna - PMR connection SK



Thanks to Telesys - Tunisia



serie/series

# acqua

example code:  
 | art. | | electrification |  
 9100 | | E27 |  
 COUNTRY example code:  
 | art. | | finishing | | electrification |  
 9100 | K | E27

art.  
**9100**  
**9103**

design Ufficio Tecnico Landa



CONTEMPORARY

152 corpo acciaio inox AISI 316L  
 body stainless steel AISI 316L  
 corps acier inoxydable AISI 316L  
 cuerpo acero inox AISI 316L  
 Körper Edelstahl AISI 316L

diffusore policarbonato opale  
 diffuser polycarbonate opal  
 diffusor polycarbonato opale  
 Difuser Polykarbonat opal



stainless steel **CLEANER**  
 code OODEC  
 details: p.A62



9100K

9100 K (E27)  
 K SEN [E27]



9100

9100 (E27)  
 SEN [E27]

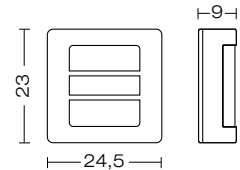

FOR TECHNICAL DETAILS VISIT  
[www.landa.it](http://www.landa.it)

IP44

850°

### FINISHING

**K**  
 dettagli / details  
 / details detalles  
 / details:  
 p.A58 - A59  
 code 9100K....

### Wood that isn't wood

Processo produttivo non inquinante  
 Production process is not polluting  
 C'est un procédé productif non polluant  
 Proceso productivo no contaminante  
 Umweltfreundlicher Herstellungsprozess



### ELECTRIFICATION

## sensor



dettagli  
 details  
 details  
 details:  
 p.A56

1x max 75 W



1x max 23 W

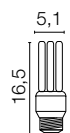

1x max 20 W

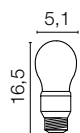

A+ ÷ E

Energy efficiency classes



Projectors

Recessed

Contemporary

Traditional

CONTEMPORARY



9103

9103 (E27)  
SEN (E27)



9103N

9103N (E27)

numeri inclusi  
included numbers  
nombres inclus  
números incluido  
einschließlich Nummern

1 2 3 4 5 6 7 8 9 0 a b  
1 2 3 4 5 6 7 8 9 0 c d  
1 2 3 4 5 6 7 8 9 0 e f

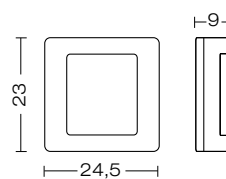

sensor



dettagli  
details  
détails  
détails:  
p.A56

1x max 75 W



1x max 23 W

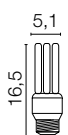

E27  
1x max 20 W

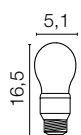

A+ ÷ E





serie/series  
**pali beta**  
**Country**  
 COLLECTION

art.  
**00PB126**  
**00PB060**

design Ufficio Tecnico Landa  
 progetto Meta-Distrettuale Numa

corpo alluminio estruso  
 body extruded aluminium  
 corps en aluminium extrudé  
 cuerpo aluminio extrusionado  
 Körper Aluminium

dettagli accessori  
 details accessories  
 details accessoires  
 detalles accesorios  
 details Zusatzgeräte  
 p.159

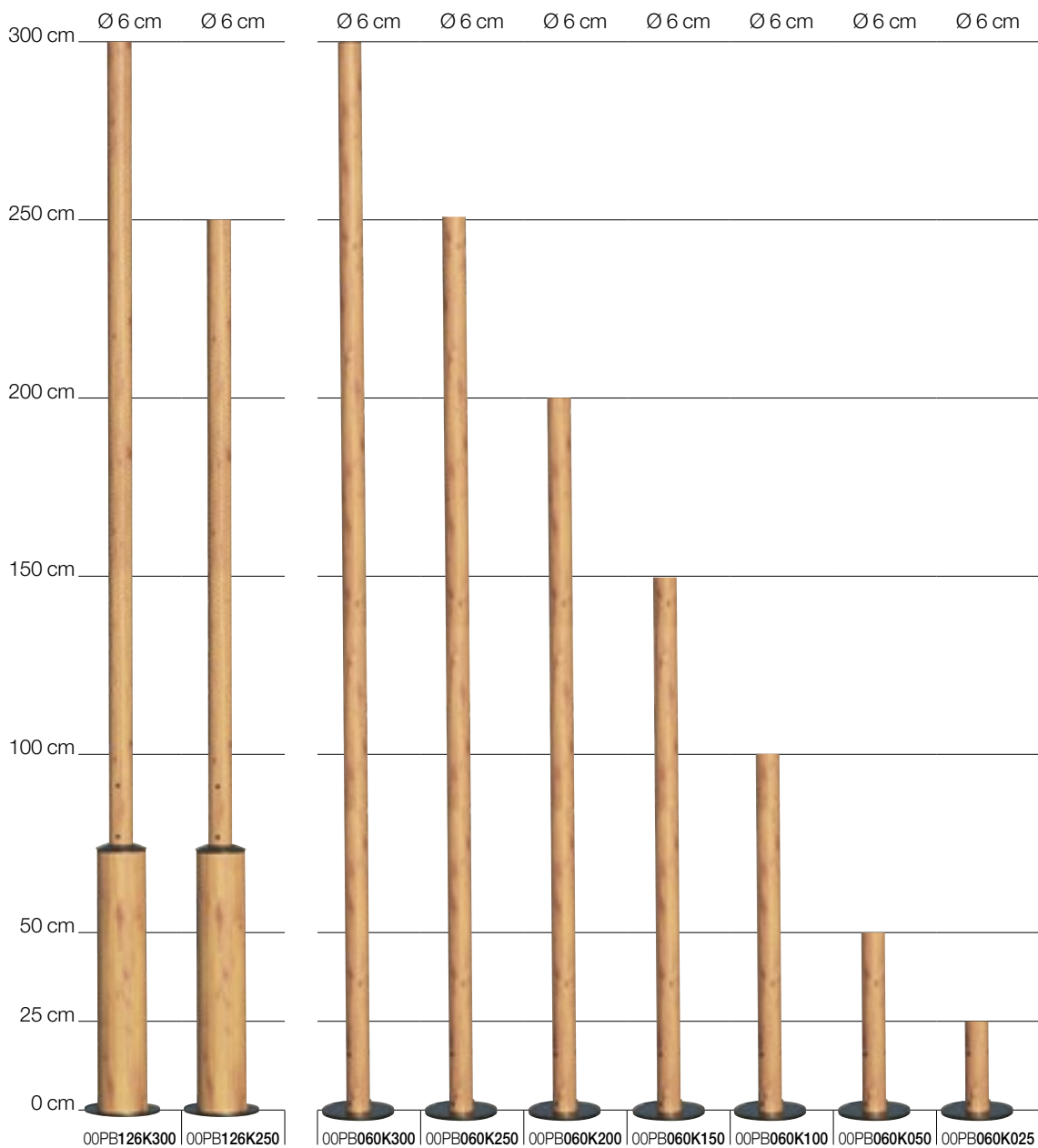

CONTEMPORARY  
 154

FOR TECHNICAL DETAILS VISIT  
[www.landa.it](http://www.landa.it)

dettagli  
 details  
 details  
 detalles  
 details:  
 p.A58 - A59



code 00PB126K....  
 code 00PB060K....

**Wood that isn't wood**

**K**  
 Processo produttivo non inquinante  
 Production process is not polluting  
 C'est un procédé productif non polluant  
 Proceso productivo no contaminante  
 Umweltfreundlicher Herstellungsprozess



Provided with door  
 inspection  
 code 00PB126K300  
 code 00PB126K250

ELECTRIFICATION

Accessoires on request:



code 0404M004  
 Single connection IP68



code 0404M003  
 Loop in loop out IP68

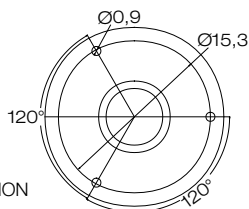

BASE DIMENSION

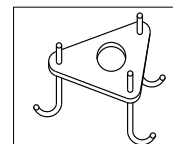

Anchor Bolt code 00APB

Energy efficiency classes

Projectors

Recessed

Contemporary

Traditional



ENERGY  
SAVING

CONTEMPORARY

155



# pali beta

art.  
**00PB126.**  
**00PB060.**

design **Ufficio Tecnico Landa**

corpo **alluminio estruso**  
 body extruded aluminium  
 corps en aluminium extrudé  
 cuerpo aluminio extrusionado  
 Körper Aluminium

dettagli **accessori**  
 details accessories  
 details accessoires  
 detalles accesorios  
 details Zusatzgeräte  
 p.159

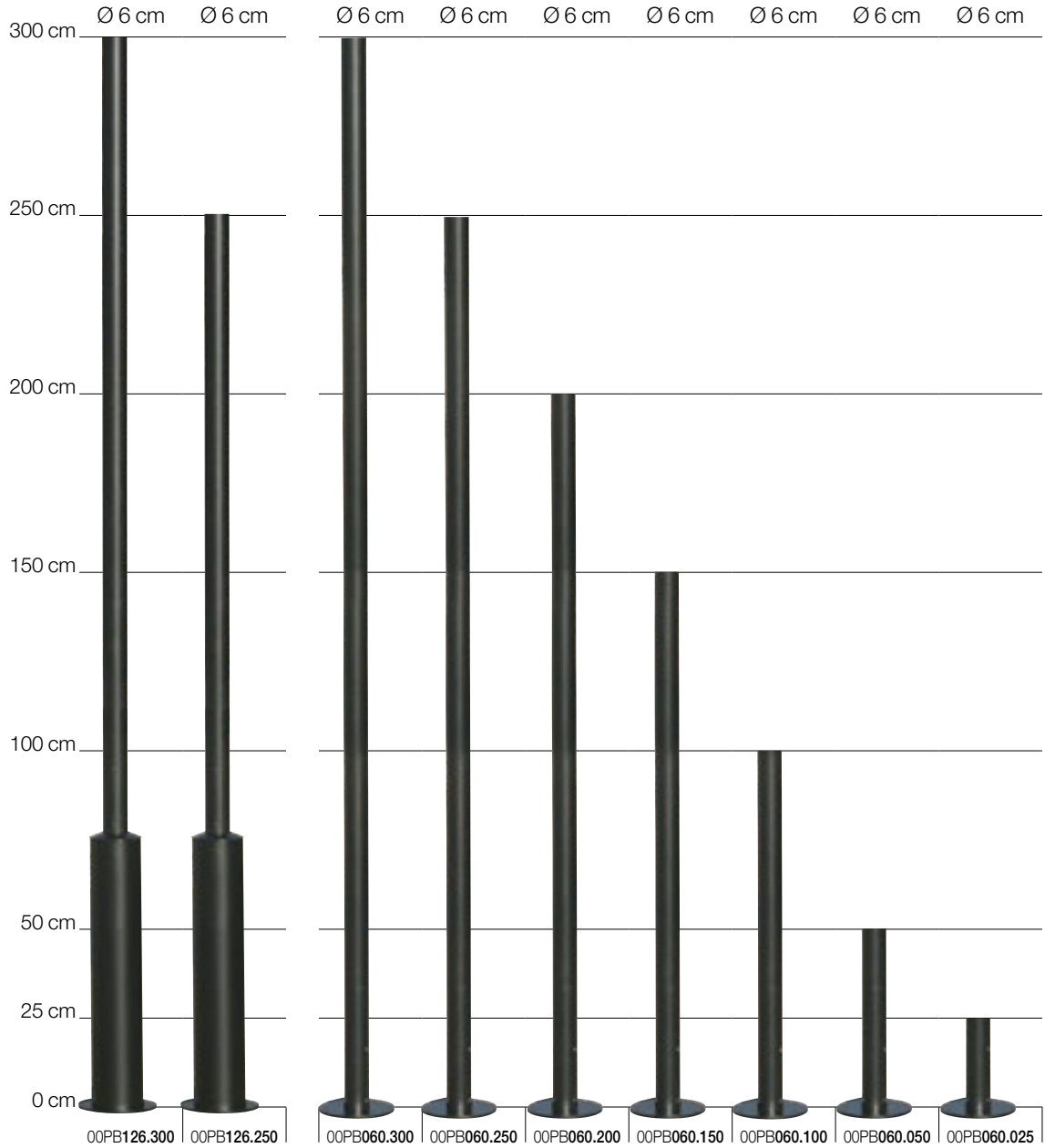

FOR TECHNICAL DETAILS VISIT  
[www.landa.it](http://www.landa.it)



code **00PB126.... ngg**

colori  
 colours  
 couleurs  
 colores  
 Farben  
 ■ **ngg**



Provided with door inspection  
 code **00PB126.300**  
 code **00PB126.250**

**ELECTRIFICATION**

Accessoires on request:



code **0404M004**  
 Single connection IP68



code **0404M003**  
 Loop in loop out IP68

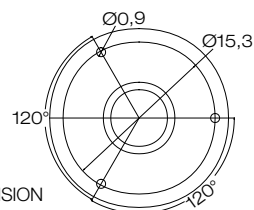

BASE DIMENSION

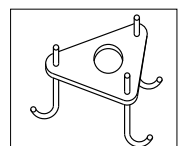

Anchor Bolt code **00APB**

Energy efficiency classes

## pali beta

Projectors

Recessed

Contemporary

Traditional



ENERGY  
SAVING

CONTEMPORARY

157



serie/series

# pali liberty

art.

## 00P170.

design Ufficio Tecnico Landa

corpo alluminio pressofuso ed estruso  
 body in die casting aluminium and extruded  
 corps en aluminium mulé sous pression et extrudé  
 cuerpo aluminio inyectado y extrusionado  
 Körper aus Aluminium-Druckguss

dettagli accessori  
 details accessories  
 details accessoires  
 detalles accesorios  
 details Zusatzgeräte  
 p.159

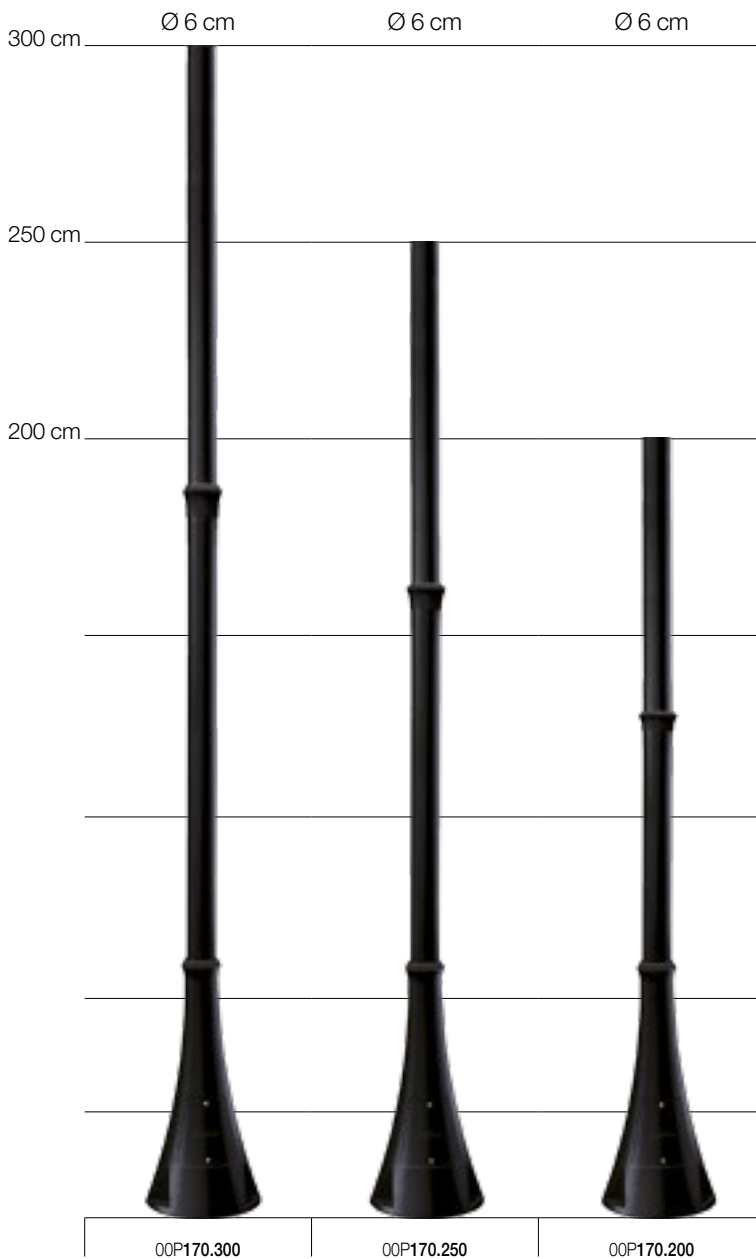

158 | CONTEMPORARY

FOR TECHNICAL DETAILS VISIT [www.landa.it](http://www.landa.it)

colori  
 colours  
 couleurs  
 colores  
 Farben



Provided with door inspection

Accessoires on request:



code 0404M004  
 Single connection IP68



code 0404M003  
 Loop in loop out IP68

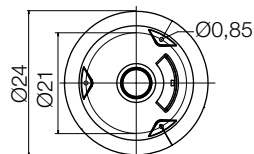

BASE DIMENSION

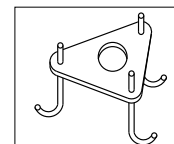

Anchor Bolt code 00A170.01P

Example to order the accessories:

**A3** + **B2** + **C1** =  
art. 00E326F42 + art. 0203140 + art. 0203141N =



Gx24q-4  
42W



	art.	W		EEC
<b>A1</b>	<b>00E326E27</b>	1x150	E27	A+ ÷ E
<b>A2</b>	<b>00E326H70</b>	1x70	E27	A+ ÷ C
<b>A3</b>	<b>00E326F42</b>	1x42	Gx24 q-4	A+ ÷ B

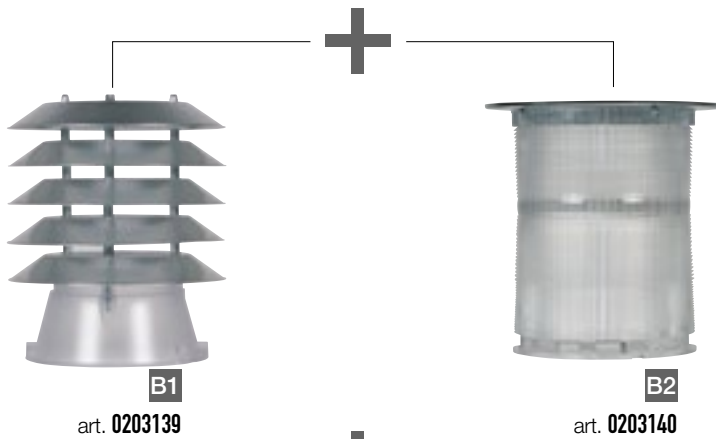

**B1**  
art. 0203139

**B2**  
art. 0203140

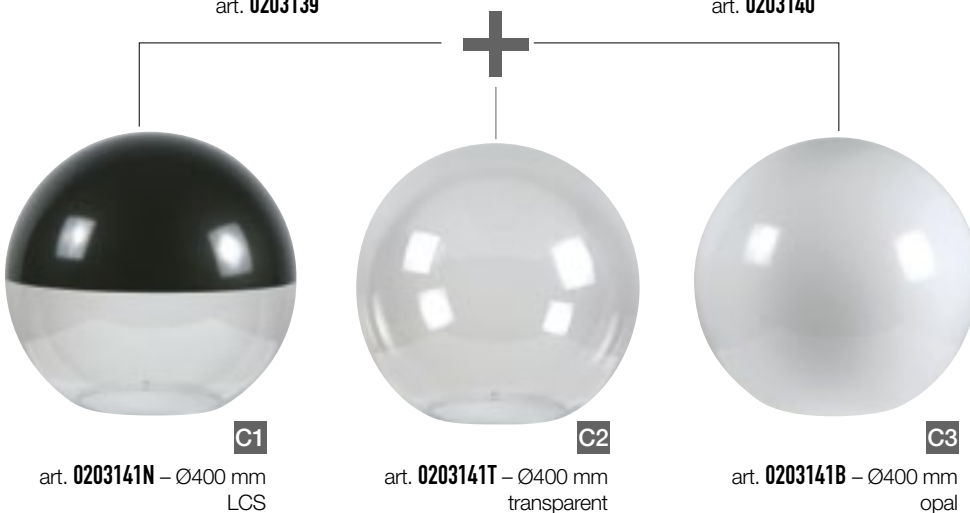

**C1**  
art. 0203141N – Ø400 mm  
LCS

**C2**  
art. 0203141T – Ø400 mm  
transparent

**C3**  
art. 0203141B – Ø400 mm  
opal

Projectors

Recessed

Contemporary

Traditional

CONTEMPORARY

159



design Ufficio Tecnico Landa

### ACCESSORIES

corpo policarbonato  
body polycarbonate  
corps polycarbonate  
cuerpo policarbonato  
Körper Polykarbonat

globi PMMA  
globes PMMA  
boules PMMA  
Globo PMMA  
Kugeln PMMA

For technical details visit  
[www.landa.it](http://www.landa.it)

IP55



# pali posts / poteaux / postes / Maste

Nuovi pali fissi realizzati tramite fusione e profilati

New cast and extruded fixed posts - Nouveaux poteaux réalisés par fusion et extrusion -

Nuevos postes fijos producidos en aluminio inyectado y perfilado - Neue fixe Maste aus Aluminiumdruckguss und Stranggepresst

160 TRADITIONAL

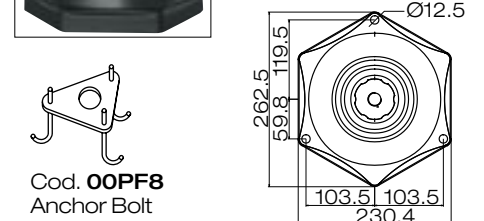
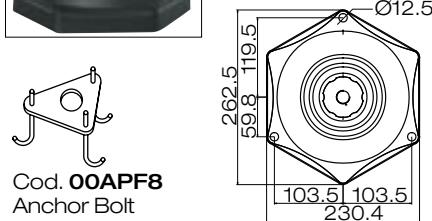
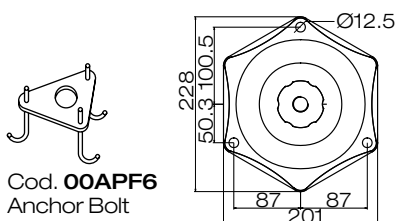
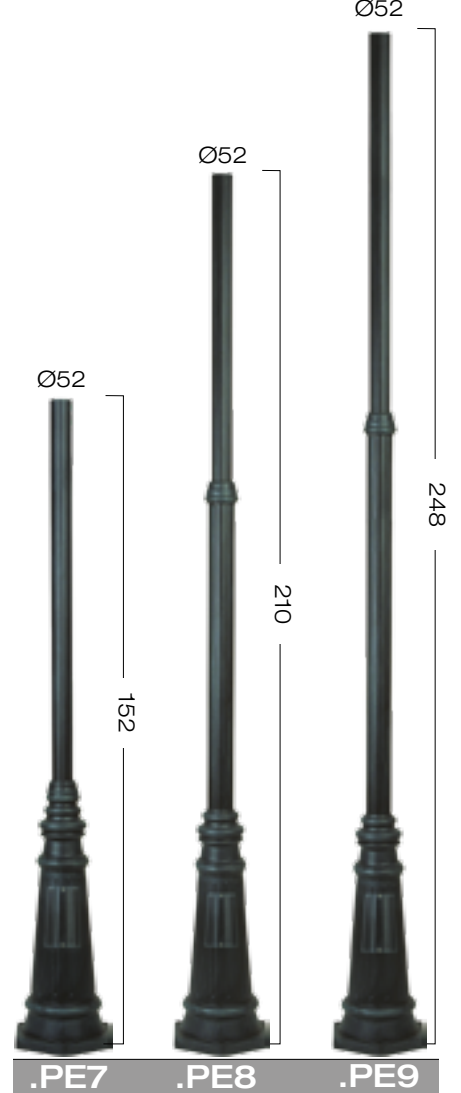
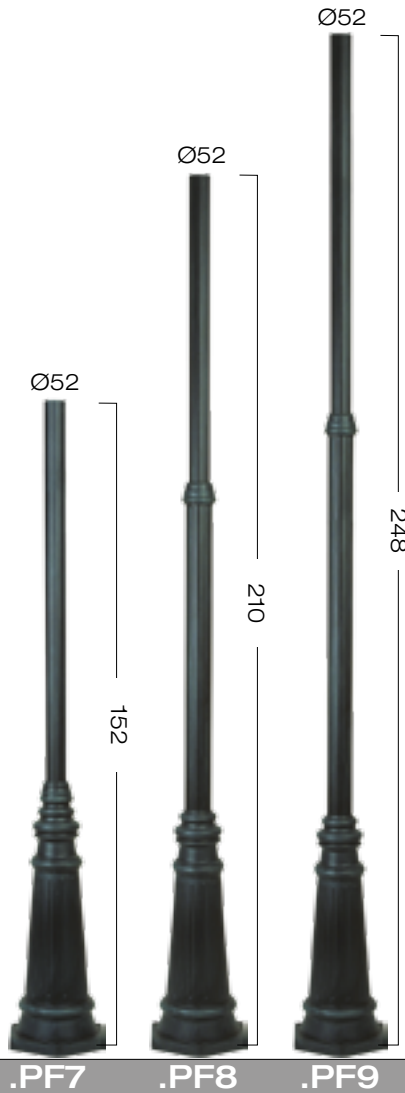
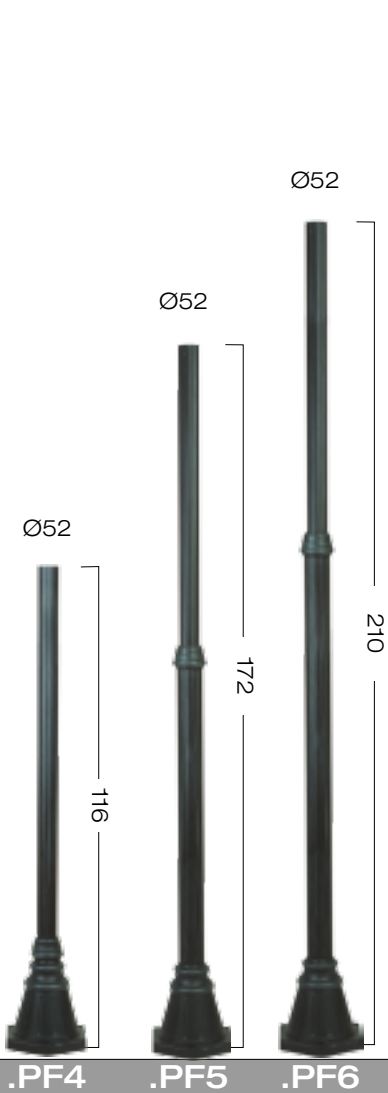



CODE: **00CRP** for posts: **.PF - .PE - .PR**

Nuovi pali regolabili in altezza realizzati tramite fusione e profilati  
 New cast and extruded posts with adjustable height. - Nouveaux poteaux réglables en hauteur réalisés par fusion et extrusion. - Nuevos postes ajustables en altura en aluminio inyectado y perfilado. - Neue höhenverstellbare Maste aus Aluminiumdruckguss und stranggepresst.

- Piastra in acciaio compressa
- Stainless steel plate included
- Embase en acier inox comprise
- Chepa en acer inox incluida
- Edelstahl Platte inklusive

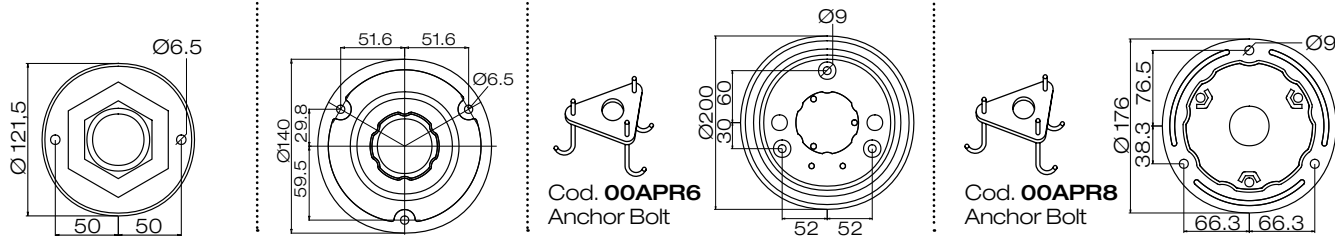
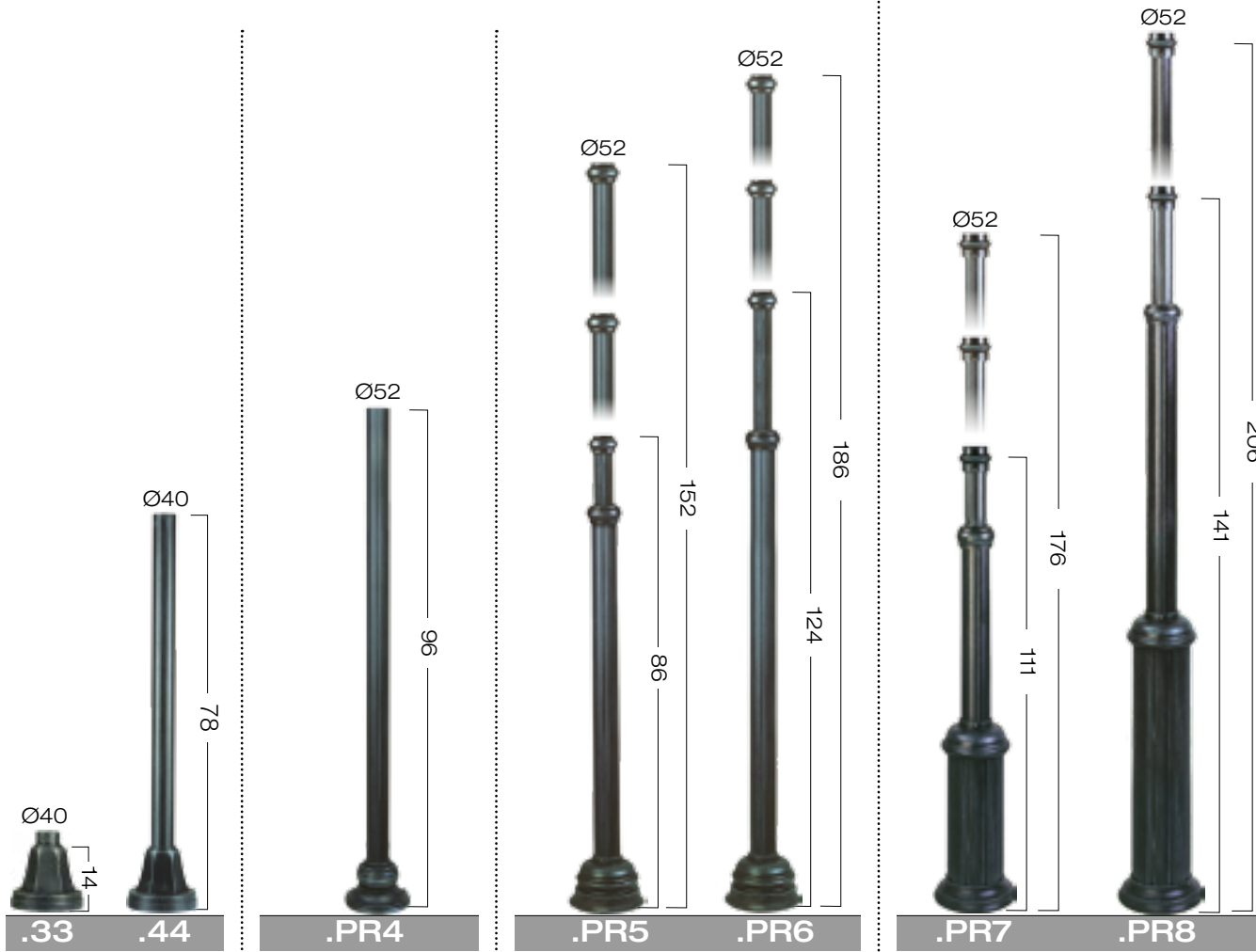



# parigi mini

art.  
**370**

example code:  
| art. | finishing | size | colour |  
370 . 00 ngv



162 | TRADITIONAL

corpo alluminio pressofuso  
body in die casting aluminium  
corps en aluminium moulé  
sous pression  
cuerpo aluminio inyectado  
Körper aus Aluminium-  
Druckguss

diffusore policarbonato  
trasparente  
diffuser transparent  
polycarbonate  
diffuser polycarbonate  
transparent  
difusor policarbonato  
transparente  
Diffuser Polykarbonat klar

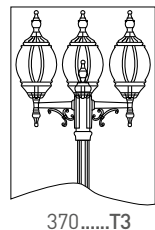
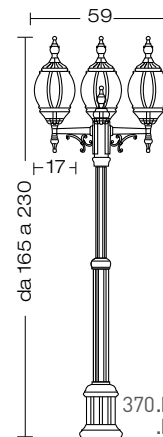
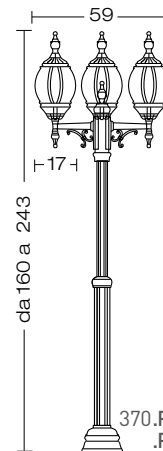
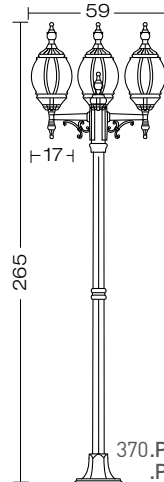
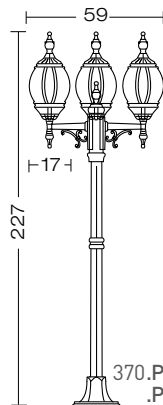
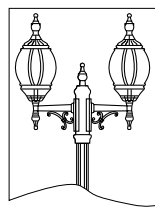
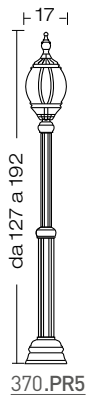
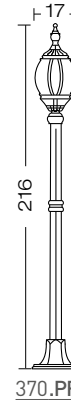
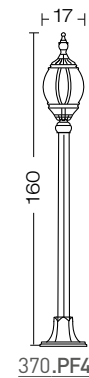
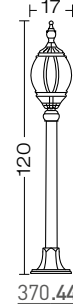
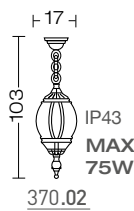
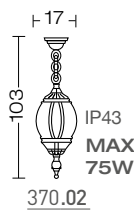
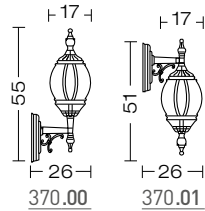
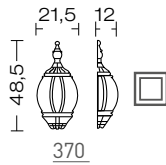

dettagli / details / details detalles / details:  
p.160-161

FOR TECHNICAL DETAILS VISIT  
[www.landa.it](http://www.landa.it)

IP44

96°

ELECTRIFICATION

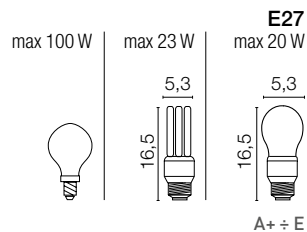

Energy efficiency classes

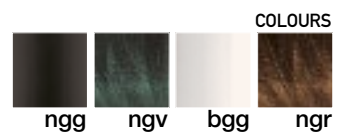

COLOURS

ngg ngv bgg ngr

parigi mini

Projectors

Recessed

Contemporary

Traditional

TRADITIONAL



163



Thanks to Creative Solution - GR



Accessories on request:



code 0404M004  
Single connection IP68



code 0404M003  
Loop in loop out IP68

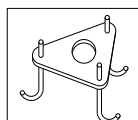

Anchor Bolt:  
code 00APF6

370.PF4.....  
370.PF5.....  
370.PF6.....

370.PR5.....  
370.PR6.....

370.PR7.....

00APR6

00APR8



# parigi

art.  
**371-372**

example code:  
art. finishing size colour  
372 . 01 ngg

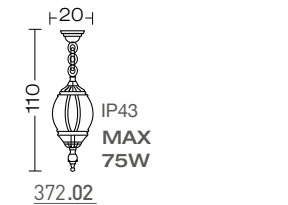
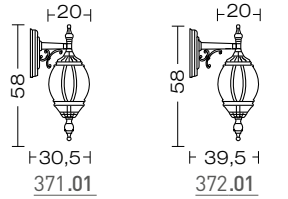
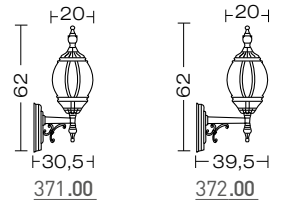

164 | TRADITIONAL

corpo alluminio pressofuso  
body in die casting aluminium  
corps en aluminium moulé  
sous pression  
cuerpo aluminio inyectado  
Körper aus Aluminium-  
Druckguss

diffusore policarbonato  
trasparente  
diffuser transparent  
polycarbonate  
diffuser polycarbonate  
transparent  
difusor policarbonato  
transparente  
Diffuser Polykarbonat klar

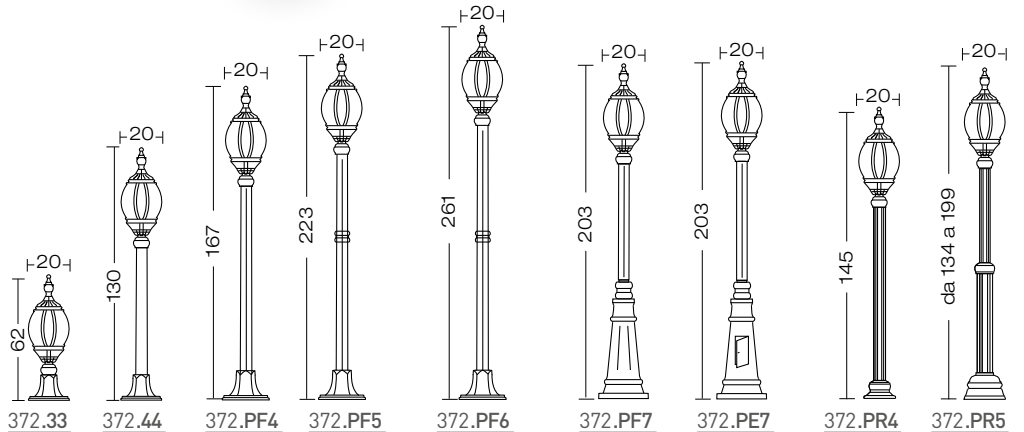

dettagli / details / details detalles / details:  
p.160-161

FOR TECHNICAL DETAILS VISIT  
[www.landa.it](http://www.landa.it)

IP44

96°

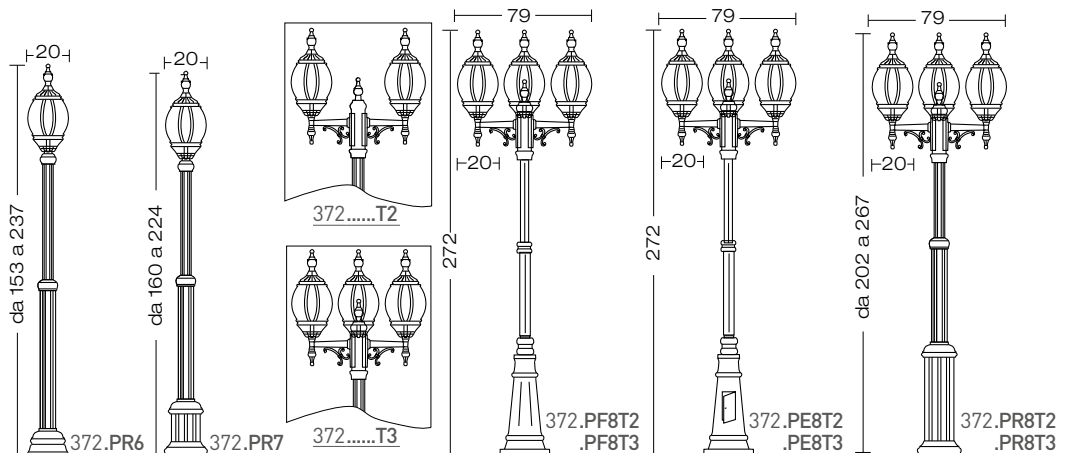

ELECTRIFICATION

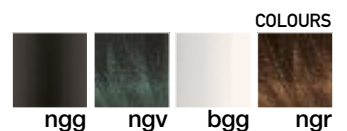
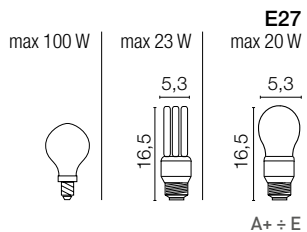

Energy efficiency classes

parigi

Projectors

Recessed

Contemporary

Traditional

TRADITIONAL

165



Thanks to Moretti Luce - IT

Accessories on request:



code 0404M004  
Single connection IP68



code 0404M003  
Loop in loop out IP68

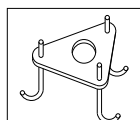

Anchor Bolt:  
code

372.PF4.....  
372.PF5.....  
372.PF6.....

00APF6

372.PF7.....  
372.PF8.....  
372.PE7.....  
372.PE8.....

00APF8

372.PR5.....  
372.PR6.....

00APR6

372.PR7.....  
372.PR8.....

00APR8



# parigi maxi

example code:  
 | art. | finishing | size | colour |  
 374 . 00 ngv

art.  
**373-374**

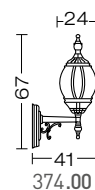
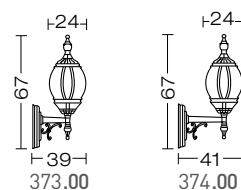

166 | TRADITIONAL

corpo alluminio pressofuso  
 body in die casting aluminium  
 corps en aluminium moulé  
 sous pression  
 cuerpo aluminio inyectado  
 Körper aus Aluminium-  
 Druckguss

diffusore policarbonato  
 trasparente  
 diffuser transparent  
 polycarbonate  
 diffuser polycarbonate  
 transparent  
 difusor policarbonato  
 transparente  
 Diffuser Polykarbonat klar

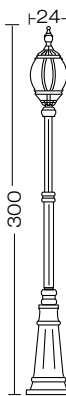
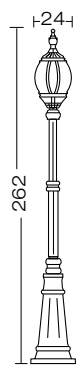
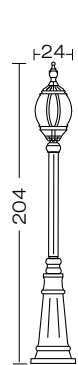
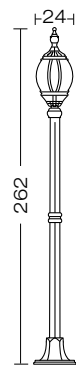
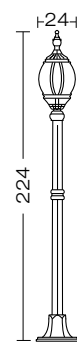
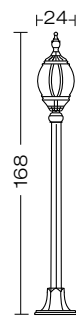
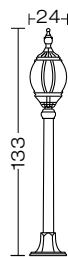
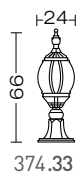
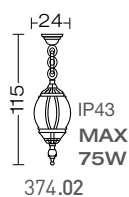

dettagli / details / details detalles / details:  
 p.160-161

FOR TECHNICAL DETAILS VISIT  
[www.landa.it](http://www.landa.it)

IP44

960°

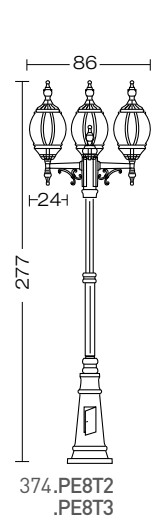
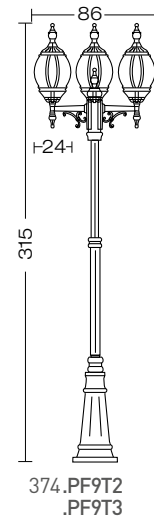
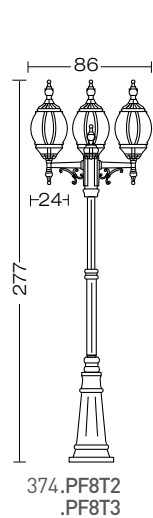
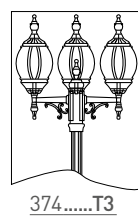
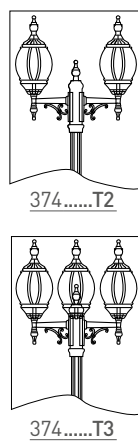
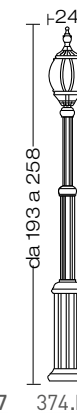
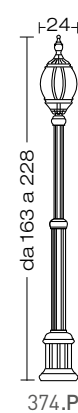
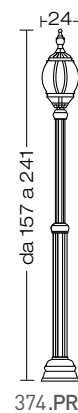
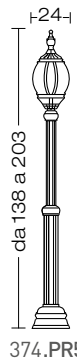
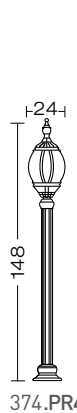

ELECTRIFICATION

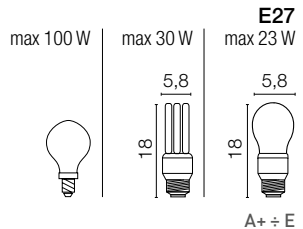

Energy efficiency classes

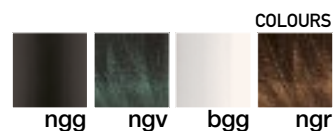

COLOURS

parigi maxi

Projectors

Recessed

Contemporary

Traditional



TRADITIONAL

167

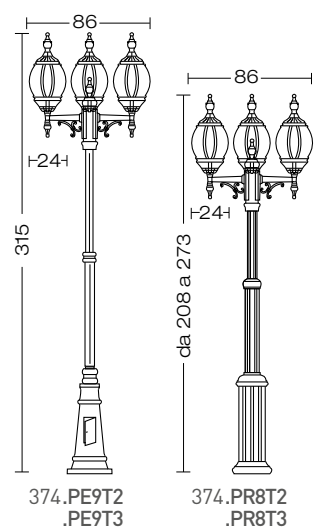
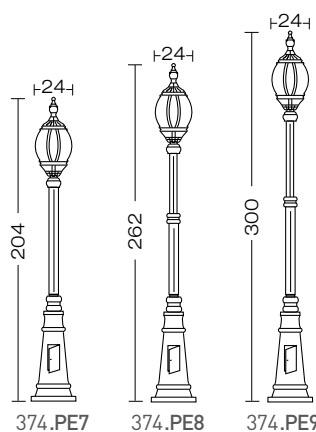
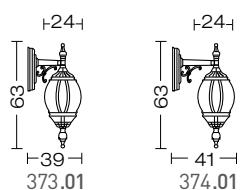

Accessories on request:



code 0404M004  
Single connection IP68



code 0404M003  
Loop in loop out IP68

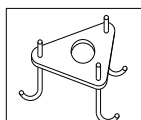

Anchor Bolt:  
code 00APF6

374.PF7.....  
374.PF8.....  
374.PF9.....  
374.PE7.....  
374.PE8.....  
374.PE9.....  
00APR6

374.PR5.....  
374.PR6.....  
00APR8

374.PR7.....  
374.PR8.....



# lampara

art.  
**100**

example code:  
| art. | finishing | size | colour |  
100 . 01 ngr  
example copper top code:  
| art. | finishing | size | colour |  
100 **A** 01 ngr



168 | TRADITIONAL

corpo alluminio pressofuso  
body in die casting aluminium  
corps en aluminium moulé  
sous pression  
cuerpo aluminio inyectado  
Körper aus Aluminium-  
Druckguss

diffusore policarbonato  
trasparente  
diffuser transparent  
polycarbonate  
diffuser polycarbonate  
transparent  
difusor policarbonato  
transparente  
Diffuser Polykarbonat klar

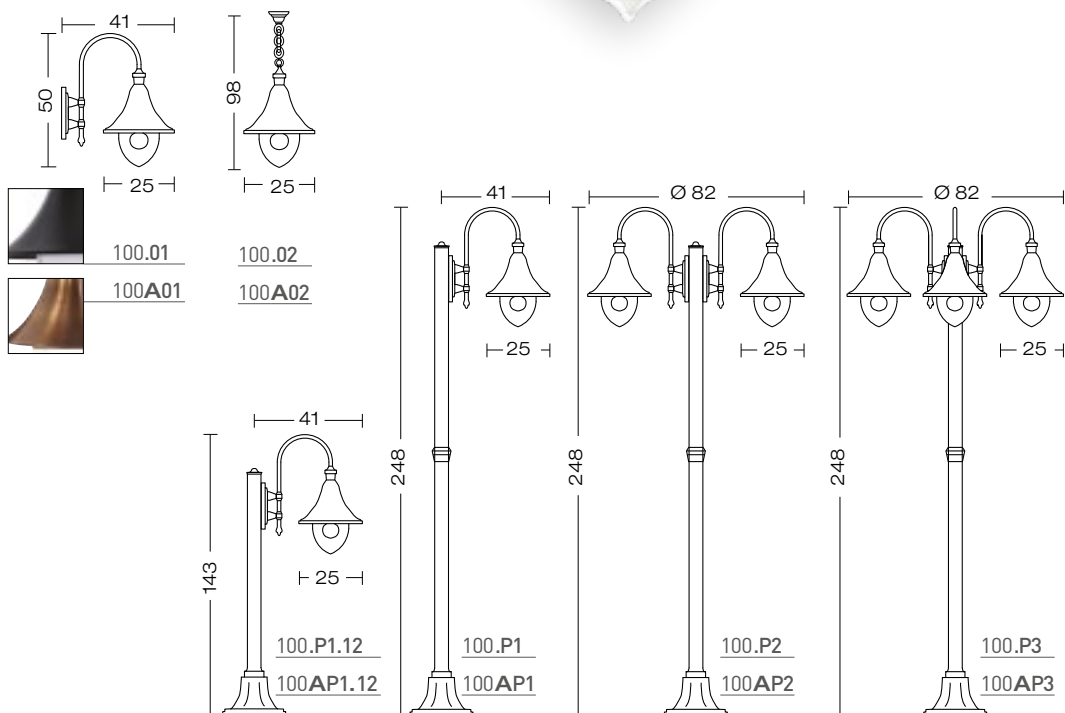

FOR TECHNICAL DETAILS VISIT  
[www.landa.it](http://www.landa.it)

IP44

850°



articoli disponibili anche con  
cappello in rame  
the items are also available  
with copper top  
ces articles sont disponibles aussi  
avec le chapeau en cuivre  
piezas disponibles  
también en cobre  
Diese Artikel sind auch mit  
Kupfer-Dach verfügbar

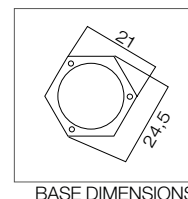

ELECTRIFICATION

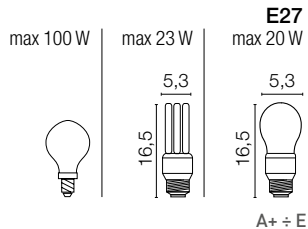

Energy efficiency classes

A+ ÷ E

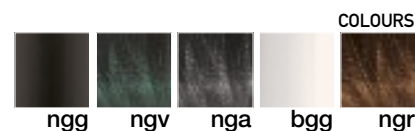

lampara



Thanks to Martin Fukna - PMR connection SK

Projectors

Recessed

Contemporary

Traditional



ENERGY SAVING

TRADITIONAL

169



Thanks to KSR Lighting - UK



Accessories on request:



code 0404M004  
Single connection IP68



code 0404M003  
Loop in loop out IP68

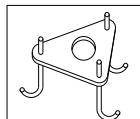

Anchor Bolt  
code 00APL6

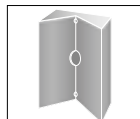

00108

angoliera  
corner bracket  
patte d'angle  
esquinera  
Eckhalterungen



esempio di fissaggio  
fixing example  
ejemplo de fijación  
Beispiel von Fixierung





# saturno

art.  
**110**

example code:

art.	finishing	size	colour
110	.	02	ngv

example copper top code:

art.	finishing	size	colour
110	<b>A</b>	02	ngv



170 | TRADITIONAL

**corpo alluminio pressofuso**  
body in die casting aluminium  
corps en aluminium moulé  
sous pression  
cuerpo aluminio inyectado  
Körper aus Aluminium-  
Druckguss

**diffusore policarbonato trasparente**  
diffuser transparent  
polycarbonate  
diffuser polycarbonate  
transparent  
difusor policarbonato  
transparente  
Diffuser Polykarbonat klar

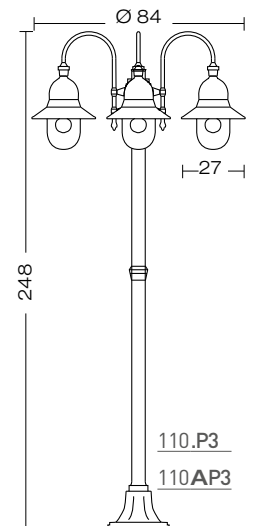
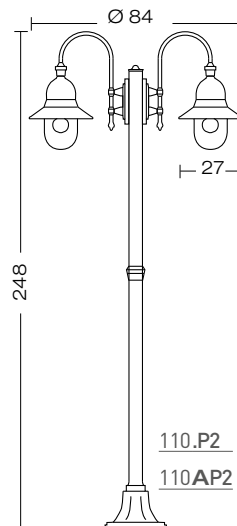
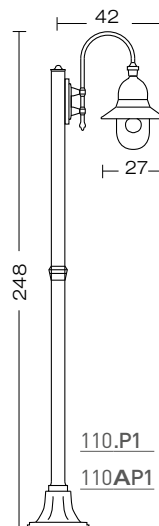
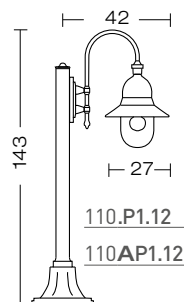
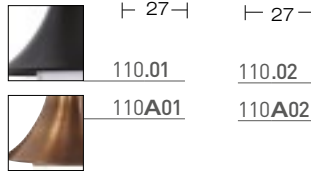
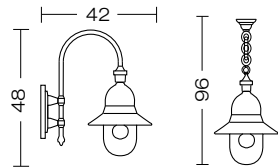

FOR TECHNICAL DETAILS VISIT  
[www.landa.it](http://www.landa.it)

IP43

960°

TOP FINISHING



code 110A....



articoli disponibili anche con cappello in rame  
the items are also available with copper top  
ces articles sont disponibles aussi avec le chapeau en cuivre  
piezas disponibles también en cobre  
Diese Artikel sind auch mit Kupfer-Dach verfügbar

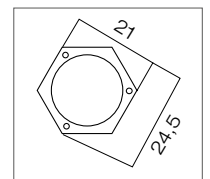

BASE DIMENSIONS

ELECTRIFICATION

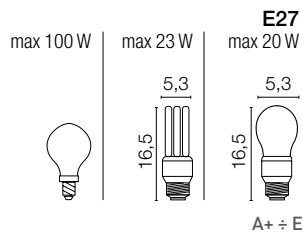

Energy efficiency classes

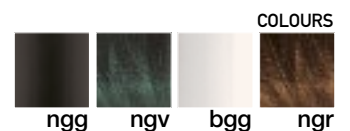

COLOURS

saturno

Thanks to Art Light - HU

Projectors

Recessed

Contemporary

Traditional

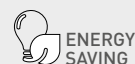

TRADITIONAL  
171



Accessories on request:



code 0404M004  
Single connection IP68



code 0404M003  
Loop in loop out IP68

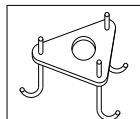

Anchor Bolt  
code 00APL6

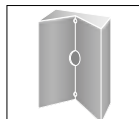

00108

angoliera  
corner bracket  
patte d'angle  
esquinera  
Eckhalterungen

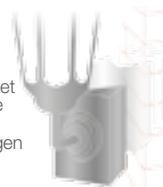

esempio di fissaggio  
fixing example  
exemple de fixation  
ejemplo de fijación  
Beispiel von Fixierung



# sirio

example code:  
 | art. | finishing | size | colour |  
 150 . P1.12 bgg

art.  
**150**



172 | TRADITIONAL

**corpo alluminio pressofuso**  
 body in die casting aluminium  
 corps en aluminium moulé  
 sous pression  
 cuerpo aluminio inyectado  
 Körper aus Aluminium-  
 Druckguss

**diffusore policarbonato opale**  
 diffuser opal polycarbonate  
 diffuser polycarbonate opale  
 difusor policarbonato ópalo  
 Diffuser Polykarbonat opal

FOR TECHNICAL DETAILS VISIT  
[www.landa.it](http://www.landa.it)

IP43

850°

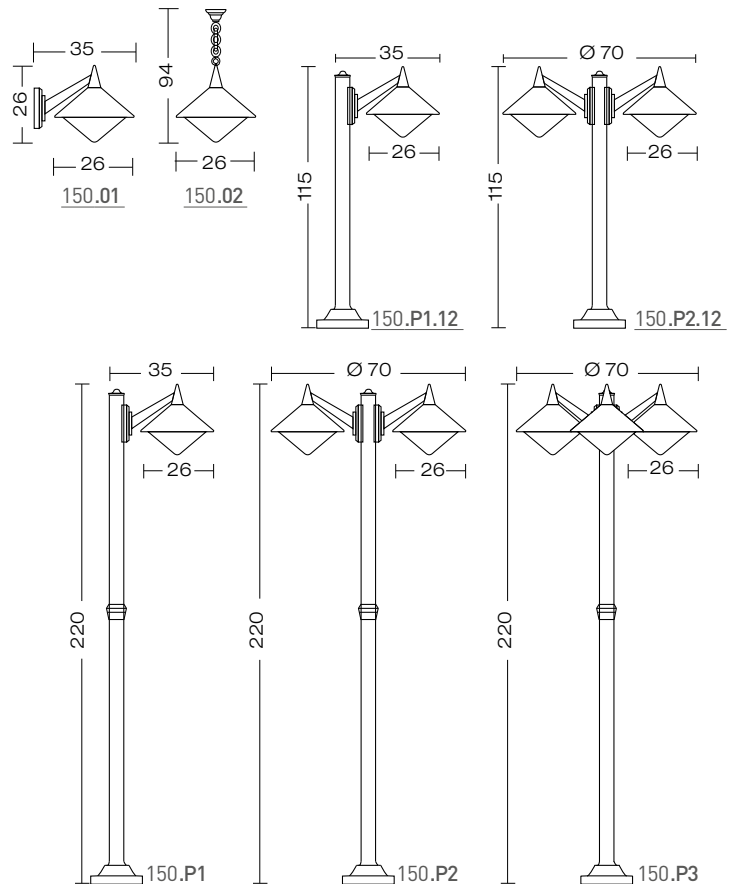

**ELECTRIFICATION**

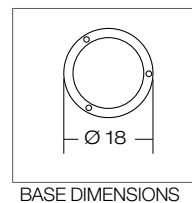
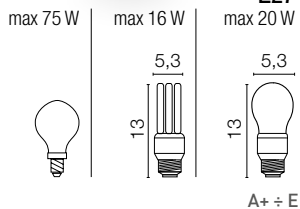

Energy efficiency classes

sirio

Projectors

Recessed

Contemporary

Traditional

TRADITIONAL



Lighting design : Apostolis Kouikoglou  
Photo : Chatzitzanos  
Place : Niriides Hotel Methoni Greece



Lighting design : Apostolis Kouikoglou  
Photo : Chatzitzanos  
Place : Niriides Hotel Methoni Greece



Accessories on request:

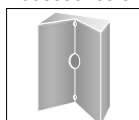

angoliera  
corner bracket  
patte d'angle  
esquinera  
Eckhalterungen

00108



esempio di fissaggio  
fixing example  
exemple de fixation  
ejemplo de fijación  
Beispiel von Fixierung



# toscana

art.  
**165**

example code:  
| art. | finishing | size | colour |  
165 . 02 ngr  
example copper top code:  
| art. | finishing | size | colour |  
165 **A** 02 ngr

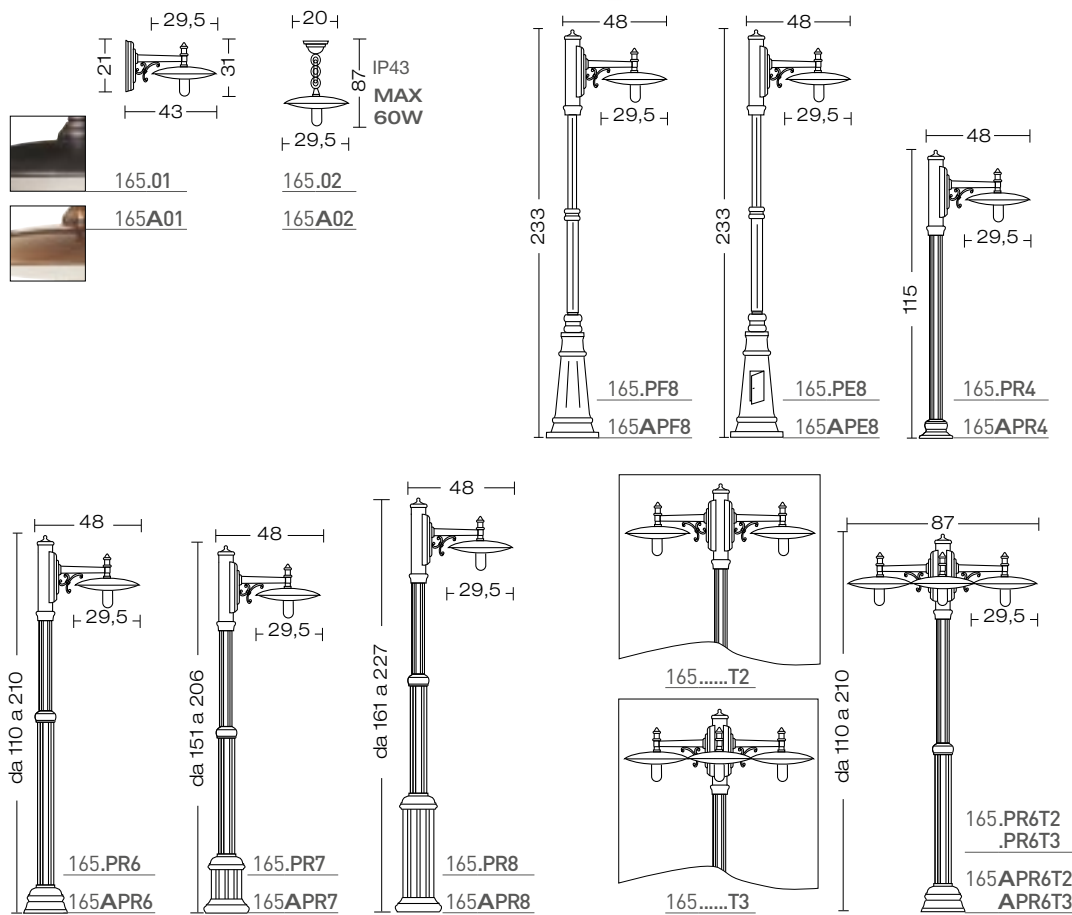
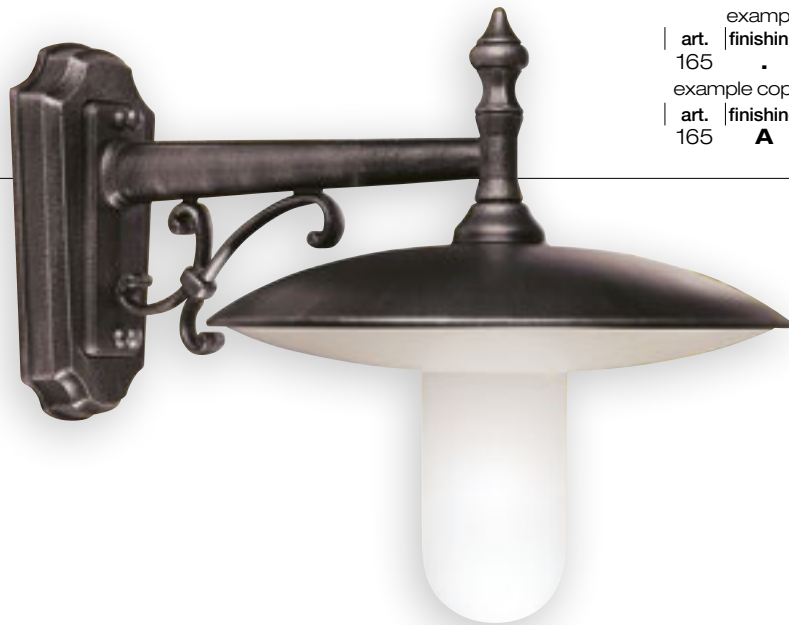

174 | TRADITIONAL

corpo alluminio pressofuso  
body in die casting aluminium  
corps en aluminium moulé  
sous pression  
cuerpo aluminio inyectado  
Körper aus Aluminium-  
Druckguss

diffusore vetro opale  
diffuser glass opal  
diffuser verre opale  
difusor vidrio ópalo  
Diffuser Glas opal

dettagli / details / details detalles / details:  
p.160-161

FOR TECHNICAL DETAILS VISIT  
[www.landa.it](http://www.landa.it)

IP44

TOP FINISHING



code 165A.....



articoli disponibili anche con  
cappello in rame  
the items are also available  
with copper top  
ces articles sont disponibles aussi  
avec le chapeau en cuivre  
piezas disponibles  
también en cobre  
Diese Artikel sind auch mit  
Kupfer-Dach verfügbar

ELECTRIFICATION

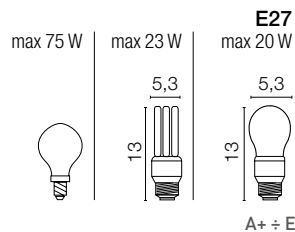

Energy efficiency classes

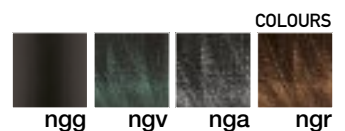

COLOURS

ngg ngv nga ngr

Projectors

Recessed

Contemporary

Traditional

TRADITIONAL

175



Thanks to Aulix - CZ

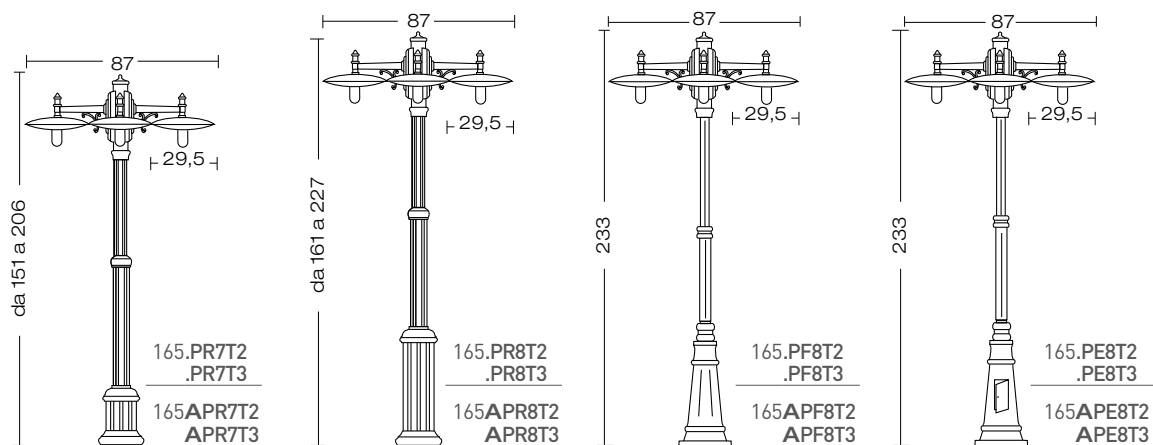

Accessories on request:



code 0404M004  
Single connection IP68



code 0404M003  
Loop in loop out IP68

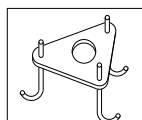

Anchor Bolt:  
code 00APF8

165.PF8.....  
165.PE8.....

165.PR6.....  
00APR6

165.PR7.....  
165.PR8.....  
00APR8



# toscana

art.  
**160**

example code:  
| art. | finishing | size | colour |  
160 . PF8 ngr  
example copper top code:  
| art. | finishing | size | colour |  
160 **A** PF8 ngr

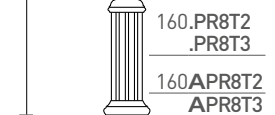
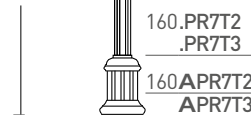
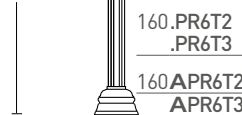
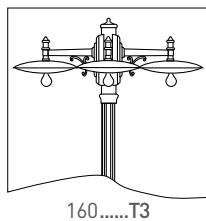
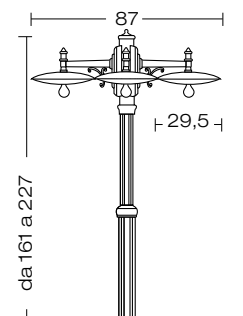
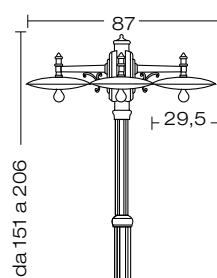
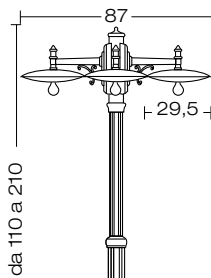
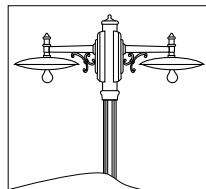
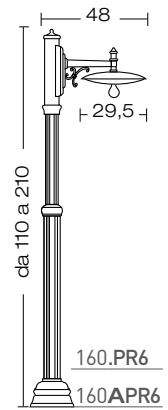
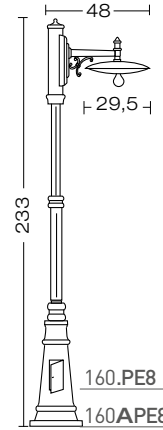
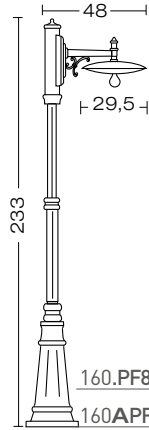
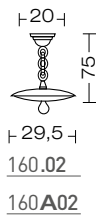
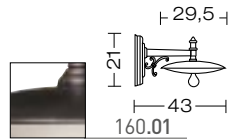

corpo alluminio pressofuso  
body in die casting aluminium  
corps en aluminium moulé  
sous pression  
cuerpo aluminio inyectado  
Körper aus Aluminium-  
Druckguss

dettagli / details / details detalles / details:  
p.160-161

FOR TECHNICAL DETAILS VISIT  
[www.landa.it](http://www.landa.it)

IP23

TOP  
FINISHING



code 160A.....



articoli disponibili anche con  
cappello in rame  
the items are also available  
with copper top  
ces articles sont disponibles aussi  
avec le chapeau en cuivre  
piezas disponibles  
también en cobre  
Diese Artikel sind auch mit  
Kupfer-Dach verfügbar

ELECTRIFICATION

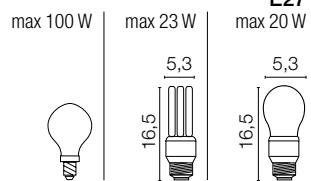

Energy efficiency classes

A+ ÷ E

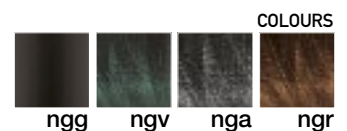

COLOURS

ngg ngv nga ngr

toscana



Projectors

Recessed

Contemporary

Traditional



TRADITIONAL

177

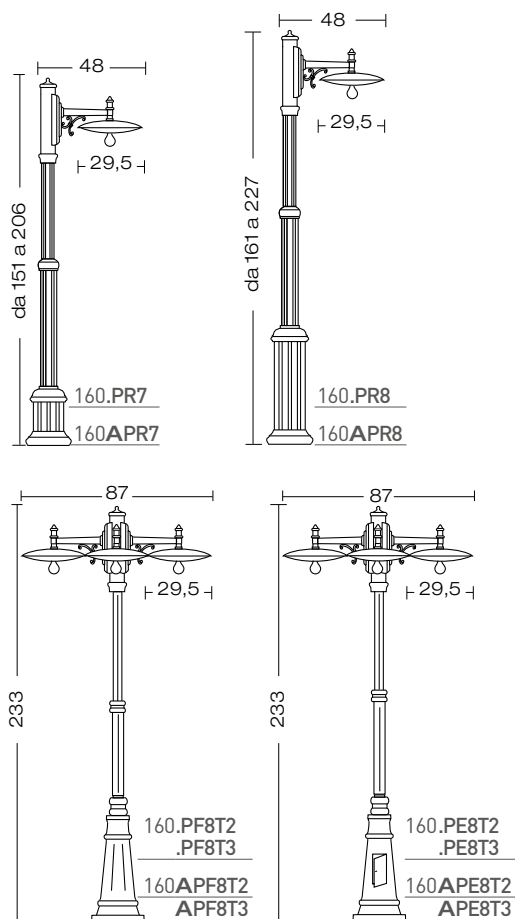

Accessories on request:



code 0404M004  
Single connection IP68



code 0404M003  
Loop in loop out IP68

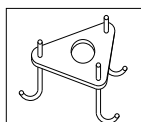

Anchor Bolt:  
code 00APF8

160.PF8.....  
160.PE8.....

160.PR6.....  
00APR6

160.PR7.....  
160.PR8.....  
00APR8





serie/series

# venezia mini

art.  
**310**

example code:  
| art. | finishing | size | colour |  
310 . 00 bgg



178 | TRADITIONAL

corpo alluminio pressofuso  
body in die casting aluminium  
corps en aluminium moulé  
sous pression  
cuerpo aluminio inyectado  
Körper aus Aluminium-  
Druckguss

diffusore policarbonato  
trasparente  
diffuser transparent  
polycarbonate  
diffuser polycarbonate  
transparent  
difusor policarbonato  
transparente  
Diffuser Polykarbonat klar

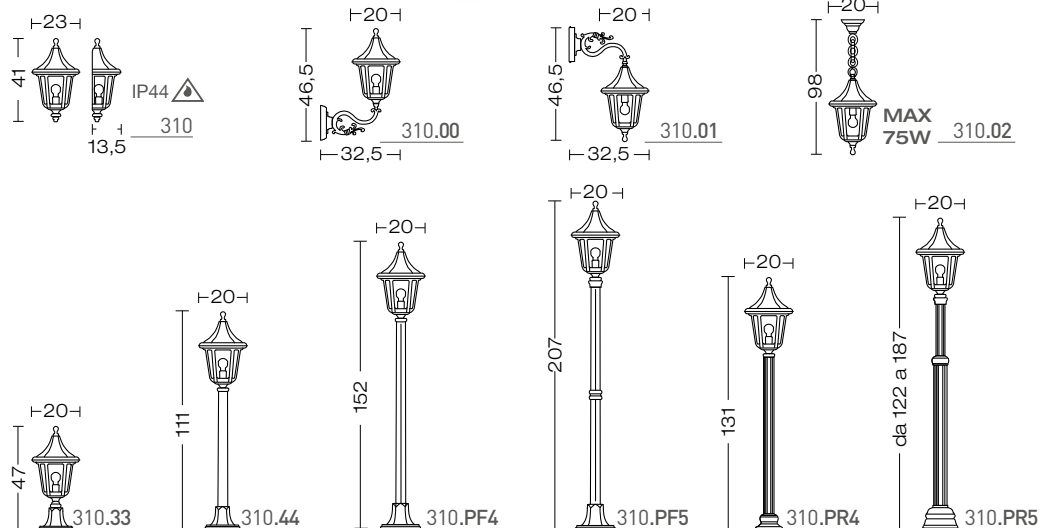

dettagli / details / details detalles / details:  
p.160-161

FOR TECHNICAL DETAILS VISIT  
[www.landa.it](http://www.landa.it)

IP43

960°

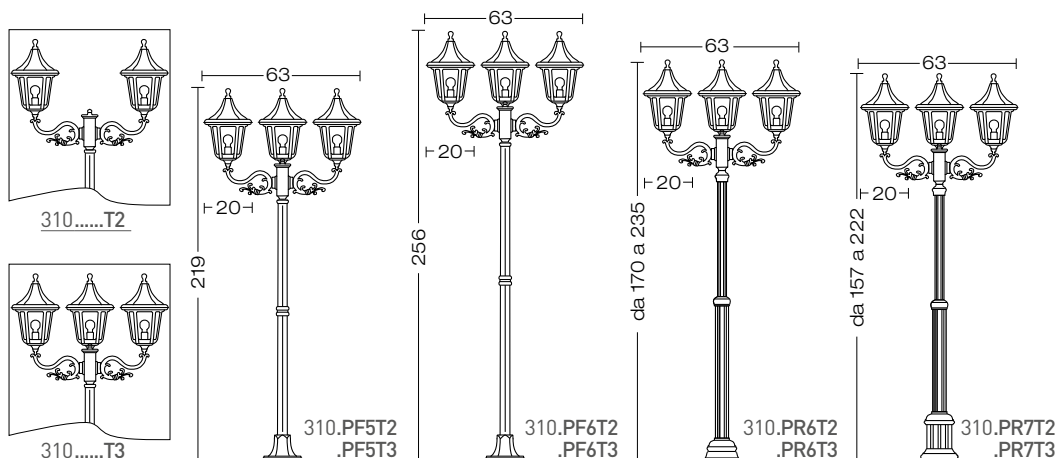

ELECTRIFICATION

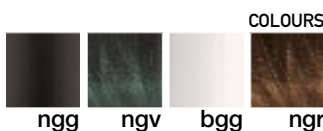
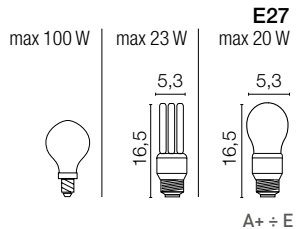

Accessories on request:



Energy efficiency classes

A+ ÷ E

venezia mini

Projectors

Recessed

Contemporary

Traditional

TRADITIONAL



179

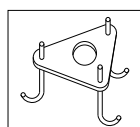

Anchor Bolt:  
code

310.PF4.....  
310.PF5.....  
310.PF6.....

00APF6

310.PR5.....  
310.PR6.....

00APR6

310.PR7.....

00APR8

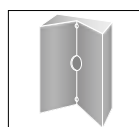

00108

angoliera  
corner bracket  
patte d'angle  
esquinera  
Eckhalterungen



esempio di fissaggio  
fixing example  
exemple de fixation  
ejemplo de fijación  
Beispiel von Fixierung



# venezia

art.  
**311-312**

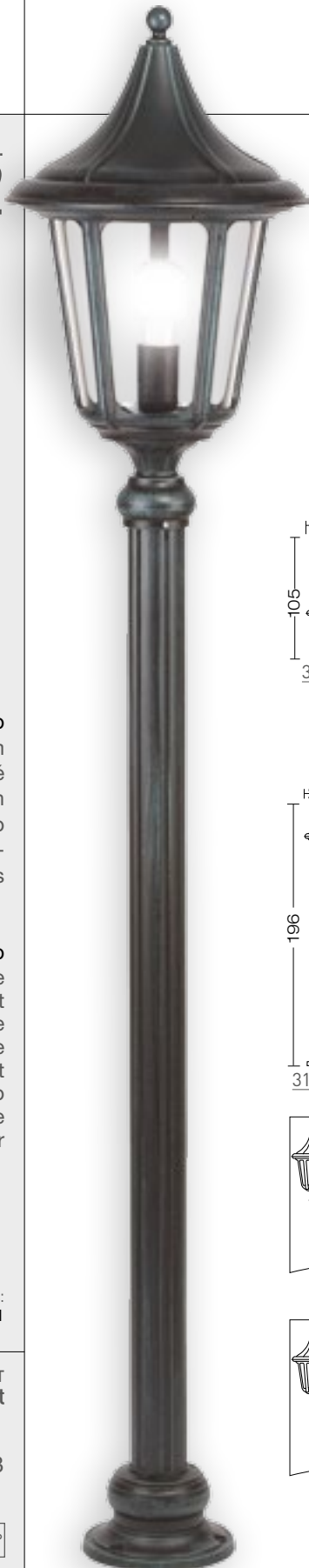

example code:  
art. finishing size colour  
312 . PF4 ngv

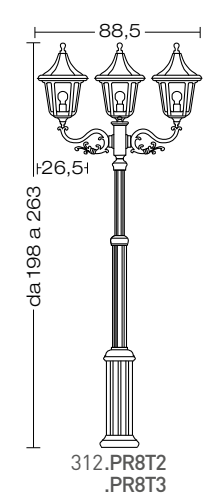
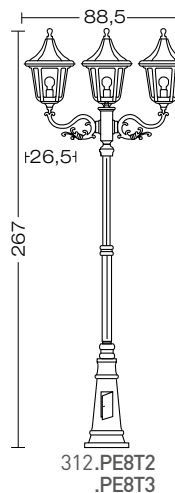
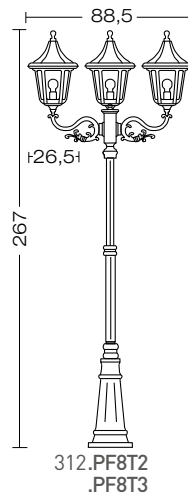
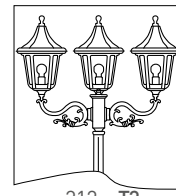
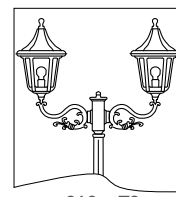
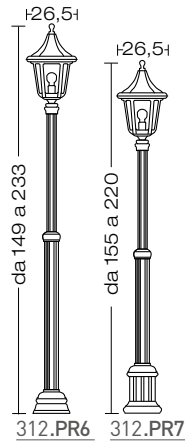
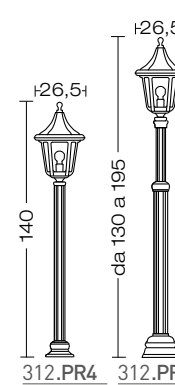
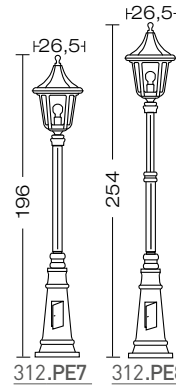
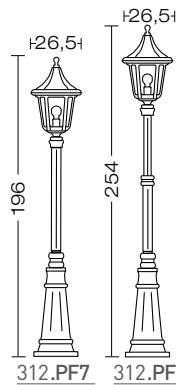
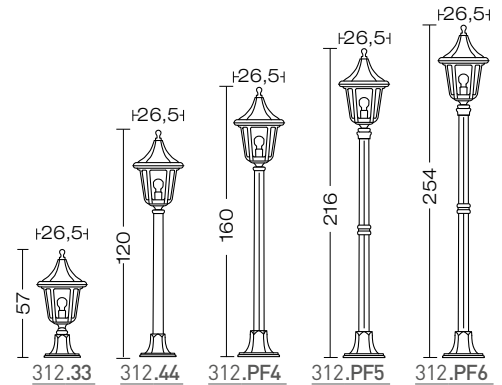
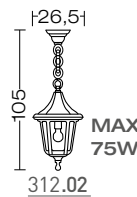
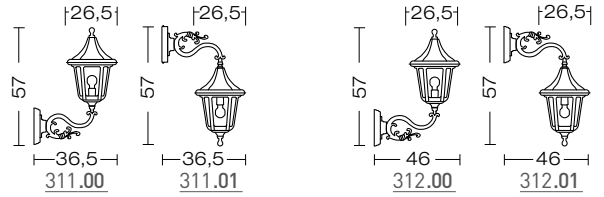

180 | TRADITIONAL

corpo alluminio pressofuso  
body in die casting aluminium  
corps en aluminium moulé  
sous pression  
cuerpo aluminio inyectado  
Körper aus Aluminium-  
Druckguss

diffusore policarbonato  
trasparente  
diffuser transparent  
polycarbonate  
diffuser polycarbonate  
transparent  
difusor policarbonato  
transparente  
Diffuser Polykarbonat klar

dettagli / details / details detalles / details:  
p.160-161

FOR TECHNICAL DETAILS VISIT  
[www.landa.it](http://www.landa.it)

IP43

960°

ELECTRIFICATION

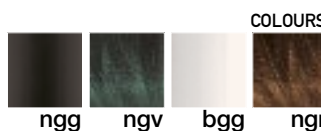
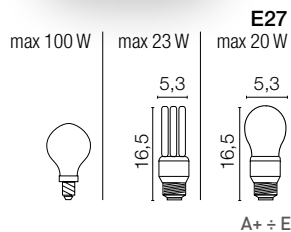

Accessories on request:



code 0404M004  
Single connection IP68



code 0404M003  
Loop in loop out IP68

Energy efficiency classes

venezia

Projectors

Recessed

Contemporary

Traditional

TRADITIONAL

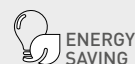

181

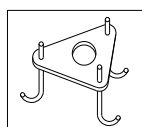

Anchor Bolt:  
code

312.PF4.....	312.PF7.....		
312.PF5.....	312.PF8.....		
312.PF6.....	312.PE7.....	312.PR5.....	312.PR7.....
	312.PE8.....	312.PR6.....	312.PR8.....

00APF6 00APF8 00APR6 00APR8

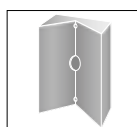

00108

angoliera  
corner bracket  
patte d'angle  
esquinera  
Eckhalterungen



esempio di fissaggio  
fixing example  
exemple de fixation  
ejemplo de fijación  
Beispiel von Fixierung



serie/series  
**amalfi**  
 mini

example code:  
 | art. | finishing | size | colour |  
 320 . 00 ngg

art.  
**320**



182 TRADITIONAL

corpo alluminio pressofuso  
 body in die casting aluminium  
 corps en aluminium moulé  
 sous pression  
 cuerpo aluminio inyectado  
 Körper aus Aluminium-  
 Druckguss

diffusore PMMA opale  
 diffuser PMMA opal  
 diffusor PMMA opale  
 difusor PMMA ópalo  
 Diffuser PMMA opal

dettagli / details / details detalles / details:  
 p.160-161

FOR TECHNICAL DETAILS VISIT  
[www.landa.it](http://www.landa.it)

IP43

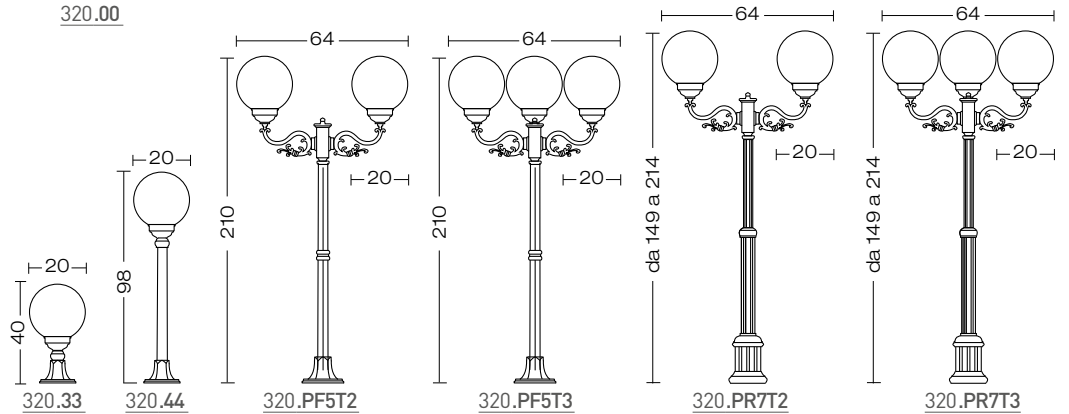
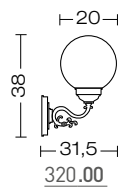

ELECTRIFICATION

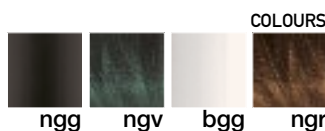
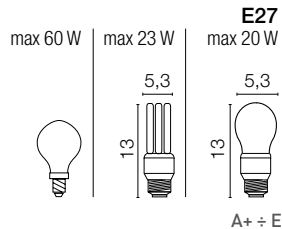

Accessories on request:



code 0404M004  
 Single connection IP68



code 0404M003  
 Loop in loop out IP68

Energy efficiency classes

amalfi mini

Projectors

Recessed

Contemporary

Traditional



TRADITIONAL

183

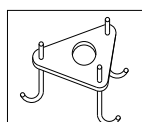
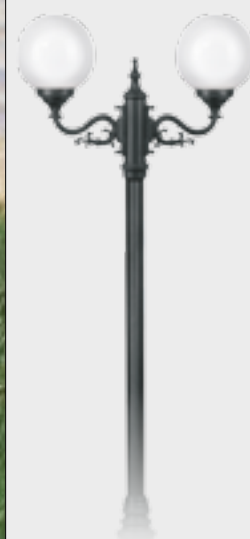

Anchor Bolt:  
code

320.PF5....

320.PR7....

00APF6

00APR8

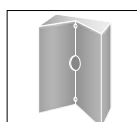

00108

angoliera  
corner bracket  
patte d'angle  
esquinera  
Eckhalterungen



esempio di fissaggio  
fixing example  
ejemplo de fijación  
Beispiel von Fixierung



# amalfi

art.  
**321-322**

example code:  
| art. | finishing | size | colour |  
322 . 00 bgg

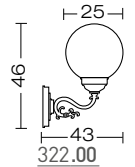
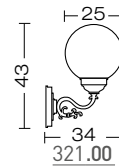

184 TRADITIONAL

corpo alluminio pressofuso  
body in die casting aluminium  
corps en aluminium moulé  
sous pression  
cuerpo aluminio inyectado  
Körper aus Aluminium-  
Druckguss

diffusore PMMA opale  
diffuser PMMA opal  
diffuser PMMA opale  
difusor PMMA ópalo  
Diffuser PMMA opal

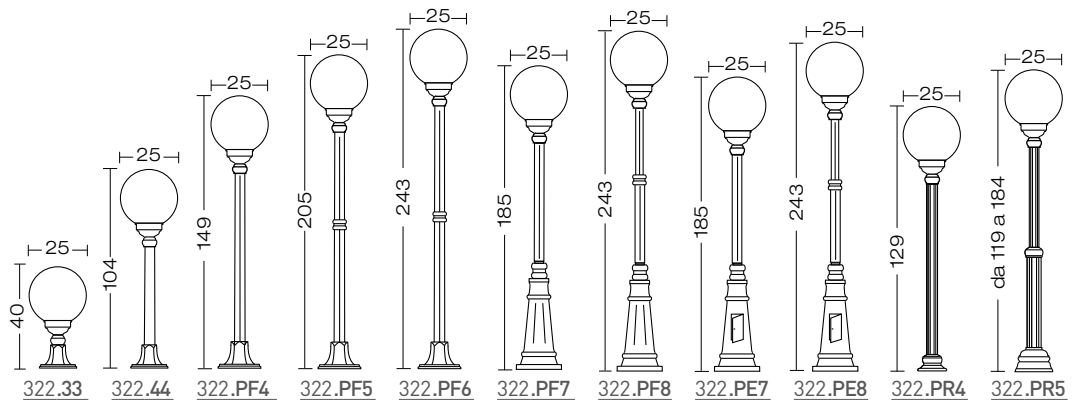

dettagli / details / details detalles / details:  
p.160-161

FOR TECHNICAL DETAILS VISIT  
[www.landa.it](http://www.landa.it)

IP43

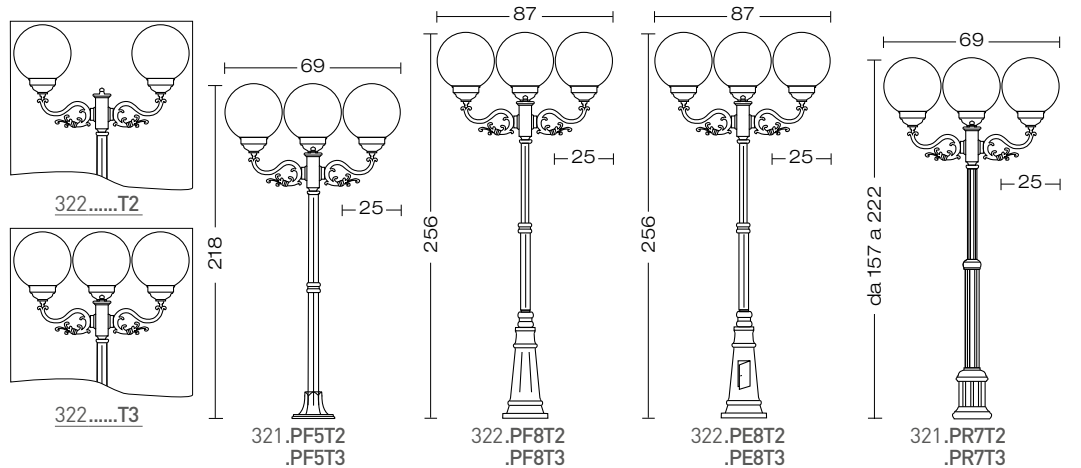

ELECTRIFICATION

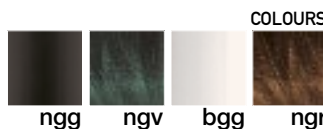
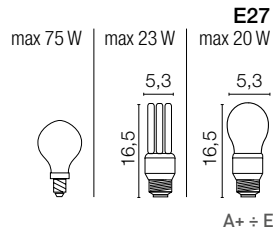

Accessories on request:



code 0404M004  
Single connection IP68



code 0404M003  
Loop in loop out IP68

amalfi

Projectors

Recessed

Contemporary

Traditional

TRADITIONAL

185

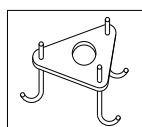
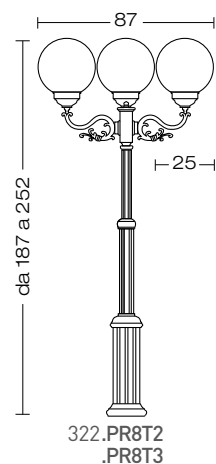
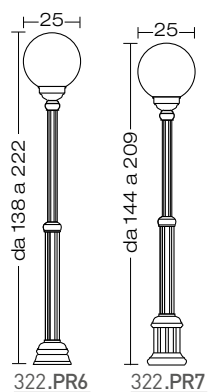

Anchor Bolt:  
code

322.PF4.....  
322.PF5.....  
322.PF6.....  
code **00APF6**

322.PF7.....  
322.PF8.....  
322.PE7.....  
322.PE8.....  
code **00APF8**

322.PR5.....  
322.PR6.....  
code **00APR6**

322.PR7.....  
322.PR8.....  
code **00APR8**

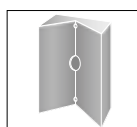

00108

angoliera  
corner bracket  
patte d'angle  
esquinera  
Eckhalterungen



esempio di fissaggio  
fixing example  
exemple de fixation  
ejemplo de fijación  
Beispiel von Fixierung





serie/series

# amalfi maxi

example code:			
art.	finishing	size	colour
323	.	33	ngv

art.  
**323**

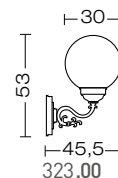

186 | TRADITIONAL

corpo alluminio pressofuso  
body in die casting aluminium  
corps en aluminium moulé  
sous pression  
cuerpo aluminio inyectado  
Körper aus Aluminium-  
Druckguss

diffusore PMMA opale  
diffuser PMMA opal  
diffuser PMMA opale  
difusor PMMA ópalo  
Diffuser PMMA opal

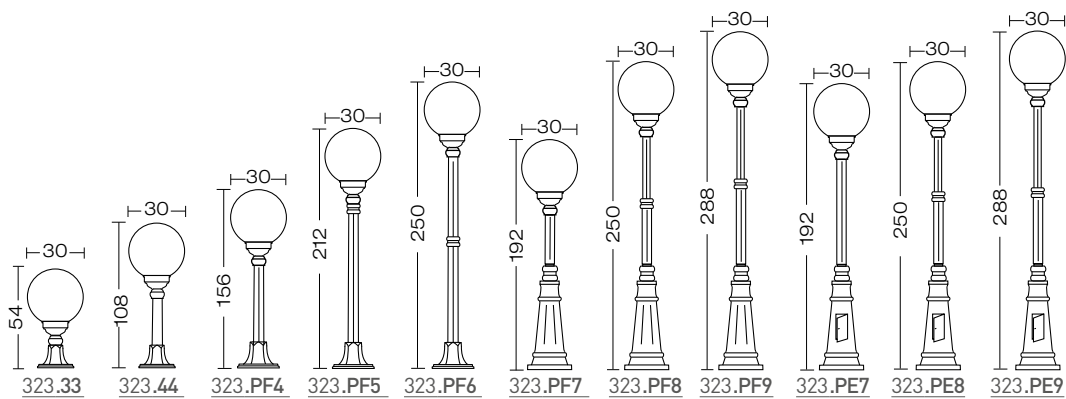

dettagli / details / details detalles / details:  
p.160-161

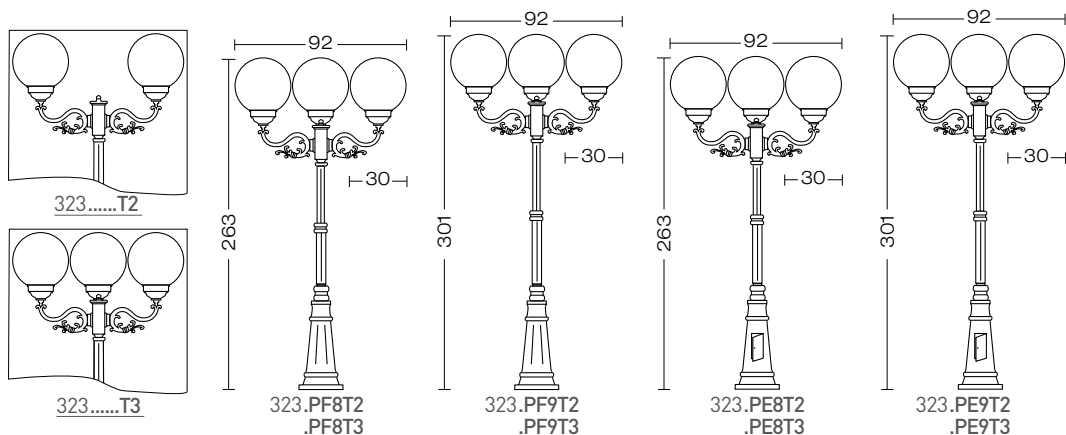

FOR TECHNICAL DETAILS VISIT  
[www.landa.it](http://www.landa.it)

IP43

### ELECTRIFICATION

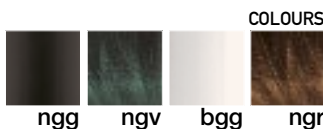
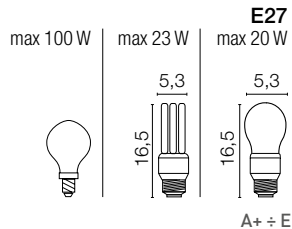

Accessories on request:



code 0404M004  
Single connection IP68



code 0404M003  
Loop in loop out IP68

Energy efficiency classes

amalfi maxi

Projectors

Recessed

Contemporary

Traditional



Thanks to Web.com - RO



TRADITIONAL

187

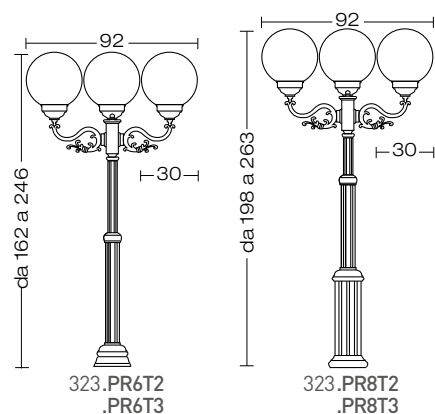
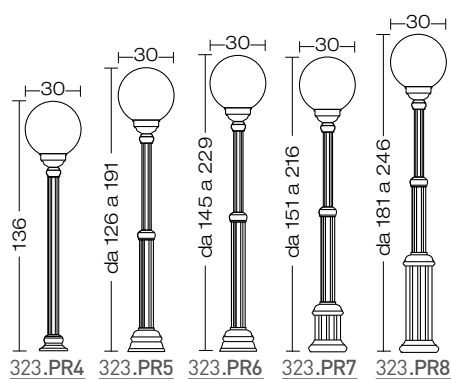

Thanks to Effect Lighting - RO

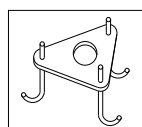
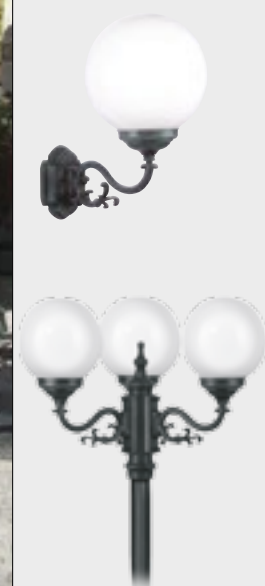

Anchor Bolt:  
code

323.PF4.....  
323.PF5.....  
323.PF6.....  
00APF6

323.PF7.....  
323.PF8.....  
323.PF9.....  
323.PE7.....  
323.PE8.....  
323.PE9.....  
00APF8

323.PR5.....  
323.PR6.....  
00APR6

323.PR7.....  
323.PR8.....  
00APR8

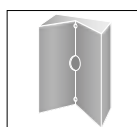

00108

angoliera  
corner bracket  
patte d'angle  
esquinera  
Eckhalterungen



esempio di fissaggio  
fixing example  
exemple de fixation  
ejemplo de fijación  
Beispiel von Fixierung



# firenze

art.  
**330**



example code:  
| art. | finishing | size | colour |  
330 . 33 nga  
example copper top code:  
| art. | finishing | size | colour |  
330 **A** 33 nga

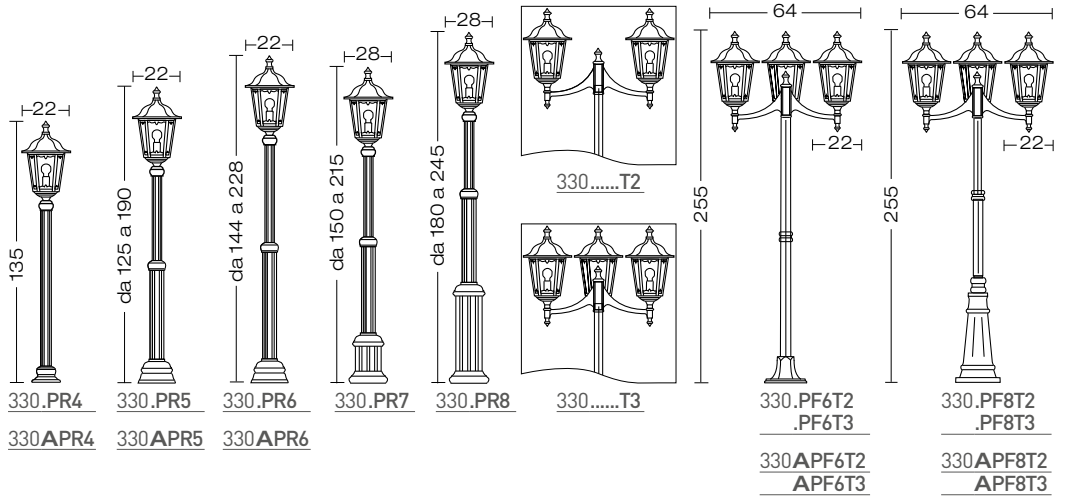
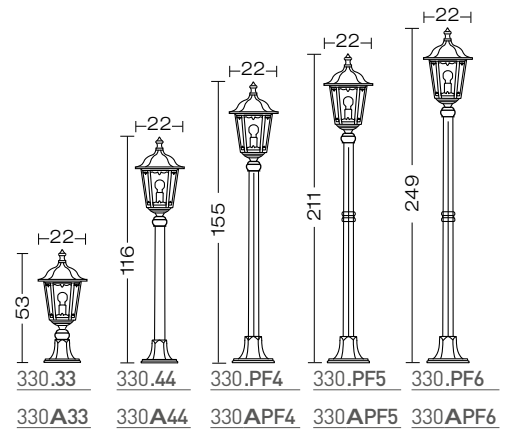
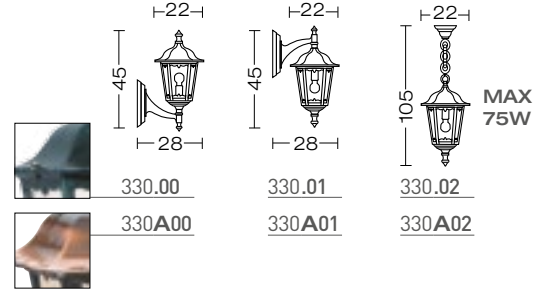

188 TRADITIONAL

corpo alluminio pressofuso  
body in die casting aluminium  
corps en aluminium moulé  
sous pression  
cuerpo aluminio inyectado  
Körper aus Aluminium-  
Druckguss

diffusore vetro  
diffuser glass  
diffuser verre  
difusor vidrio  
Diffuser Glas

dettagli / details / details detalles / details:  
p.160-161

FOR TECHNICAL DETAILS VISIT  
[www.landa.it](http://www.landa.it)

IP43

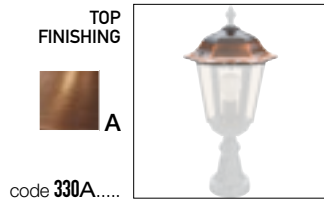

articoli disponibili anche con  
cappello in rame  
the items are also available  
with copper top  
ces articles sont disponibles aussi  
avec le chapeau en cuivre  
piezas disponibles  
también en cobre  
Diese Artikel sind auch mit  
Kupfer-Dach verfügbar

ELECTRIFICATION

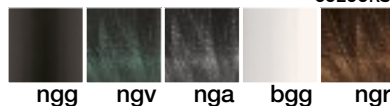
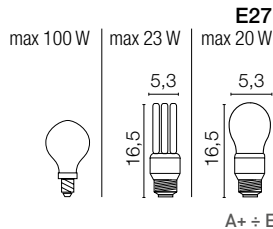

Accessories on request:

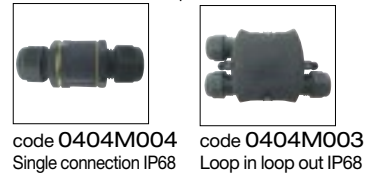

Energy efficiency classes

A+ ÷ E

firenze

Projectors

Recessed

Contemporary

Traditional

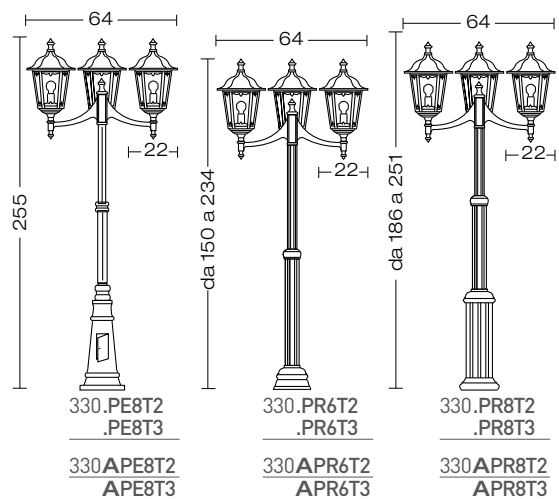
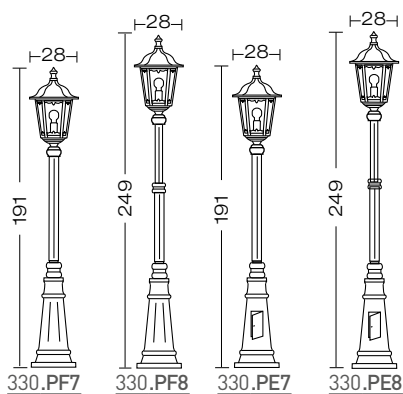

TRADITIONAL

189

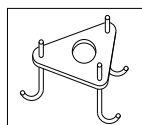

Anchor Bolt:  
code

330.PF4.....	330.PF7.....		
330.PF5.....	330.PF8.....		
330.PF6.....	330.PE7.....	330.PR5.....	330.PR7.....
	330.PE8.....	330.PR6.....	330.PR8.....
00APF6	00APF8	00APR6	00APR8

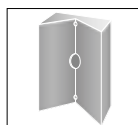

00108

angoliera  
corner bracket  
patte d'angle  
esquinera  
Eckhalterungen



esempio di fissaggio  
fixing example  
exemple de fixation  
ejemplo de fijación  
Beispiel von Fixierung



# monaco

art.  
**340**



example code:  
| art. | finishing | size | colour |  
340 . 00 nga  
example copper top code:  
| art. | finishing | size | colour |  
340 **A** 00 nga

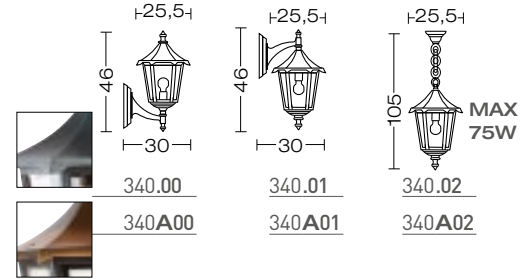

190 | TRADITIONAL

corpo alluminio pressofuso  
body in die casting aluminium  
corps en aluminium moulé  
sous pression  
cuerpo aluminio inyectado  
Körper aus Aluminium-  
Druckguss

diffusore vetro  
diffuser glass  
diffuser verre  
difusor vidrio  
Diffuser Glas

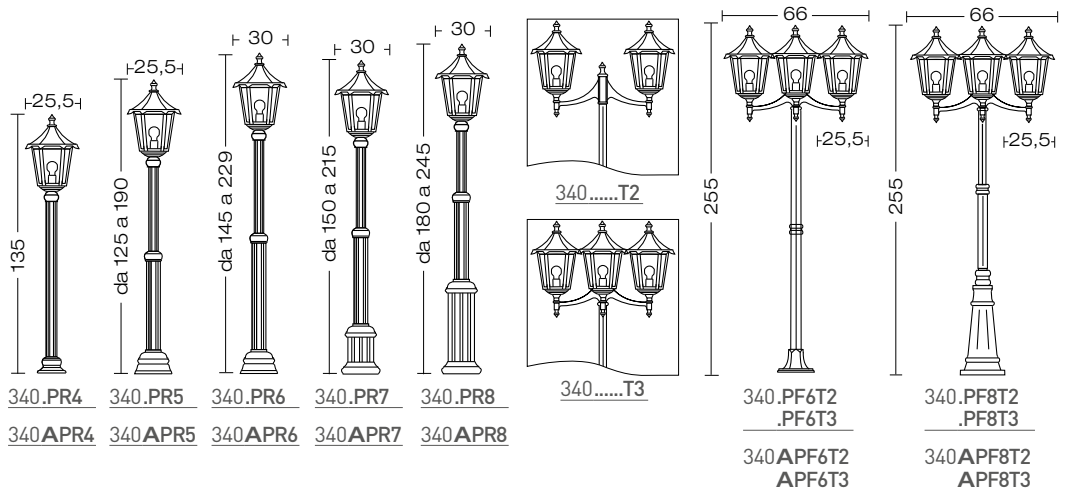
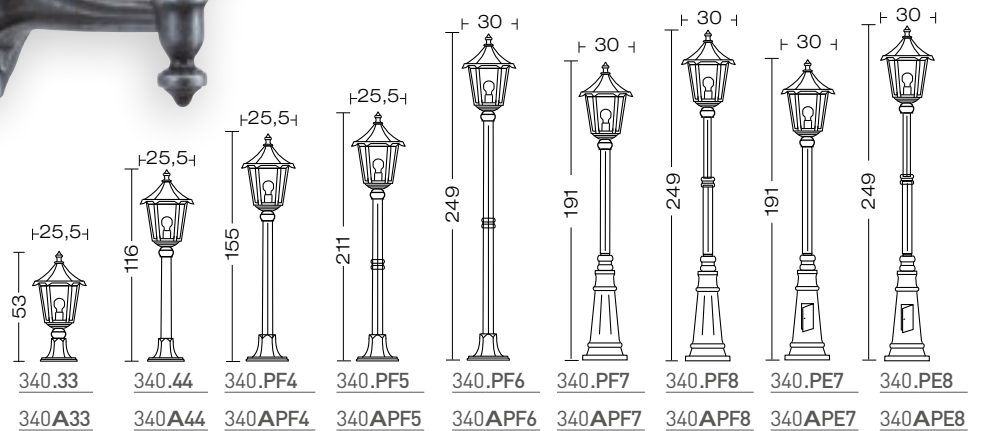

dettagli / details / details detalles / details:  
p.160-161

FOR TECHNICAL DETAILS VISIT  
[www.landa.it](http://www.landa.it)

IP43

TOP  
FINISHING



code 340A.....



articoli disponibili anche con  
cappello in rame  
the items are also available  
with copper top  
ces articles sont disponibles aussi  
avec le chapeau en cuivre  
piezas disponibles  
también en cobre  
Diese Artikel sind auch mit  
Kupfer-Dach verfügbar

ELECTRIFICATION

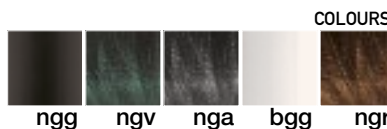
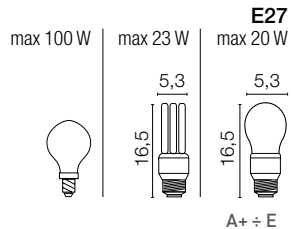

Accessories on request:



code 0404M004  
Single connection IP68



code 0404M003  
Loop in loop out IP68

Energy efficiency classes

A+ ÷ E

monaco

Projectors

Recessed

Contemporary

Traditional



TRADITIONAL

191

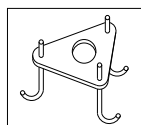
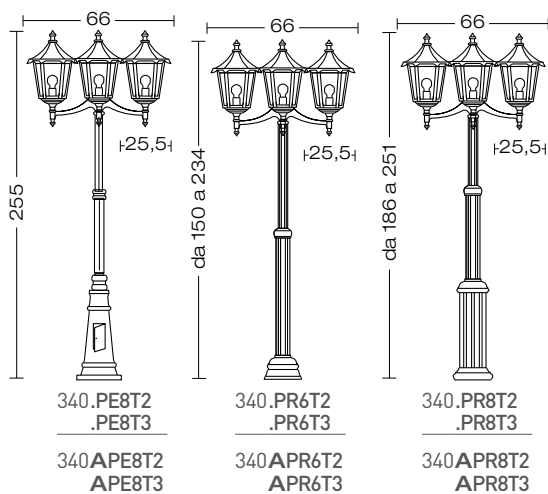

Anchor Bolt:  
code

340.PF4.....  
340.PF5.....  
340.PF6.....  
00APF6

340.PF7.....  
340.PF8.....  
340.PE7.....  
340.PE8.....  
00APF8

340.PR5.....  
340.PR6.....  
00APR6

340.PR7.....  
340.PR8.....  
00APR8

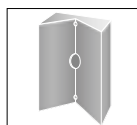

00108

angoliera  
corner bracket  
patte d'angle  
esquinera  
Eckhalterungen

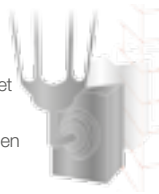

esempio di fissaggio  
fixing example  
exemple de fixation  
ejemplo de fijación  
Beispiel von Fixierung



# romantica

# LED

powered by  
Citizen Electronics® LED  
Transformer included

example code:

art.	finishing	size	LED	○	colour
350	.	01	L10	H	ngg

example copper top code:

art.	finishing	size	LED	○	colour
350	<b>A</b>	01	L10	H	ngg

art.  
**350**

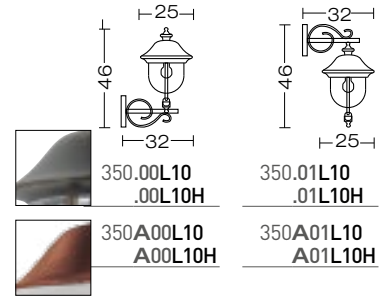

192 | TRADITIONAL

corpo alluminio pressofuso  
body in die casting aluminium  
corps en aluminium moulé  
sous pression  
cuerpo aluminio inyectado  
Körper aus Aluminium-  
Druckguss

diffusore policarbonato frosted  
diffuser frosted polycarbonate  
diffuser polycarbonate frosted  
difusor policarbonato frosted  
Diffuser Polykarbonat frosted

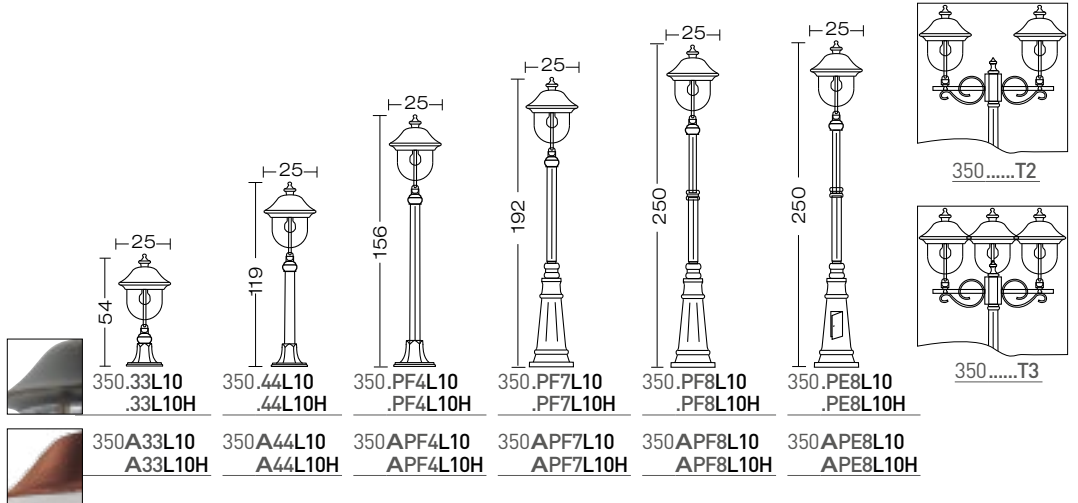

dettagli / details / details detalles / details:  
p.160-161

FOR TECHNICAL DETAILS VISIT  
[www.landa.it](http://www.landa.it)

IP43

960°

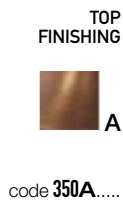

articoli disponibili anche con  
cappello in rame  
the items are also available  
with copper top  
ces articles sont disponibles aussi  
avec le chapeau en cuivre  
piezas disponibles  
también en cobre  
Diese Artikel sind auch mit  
Kupfer-Dach verfügbar

ELECTRIFICATION

# LED

dettagli / details / details  
detales / details:  
p.A54 - A55

Energy efficiency classes

**L10**  
LED 10 W  
5000K  
1300LM  
Ra80



**L10H**  
LED 10 W  
3000K  
1100LM  
Ra80



A++ ÷ A

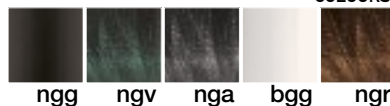

COLOURS

Accessories on request:



code **0404M004**  
Single connection IP68



code **0404M003**  
Loop in loop out IP68

romantica

Projectors

Recessed

Contemporary

Traditional

TRADITIONAL

193



Thanks to Forma Art - RU

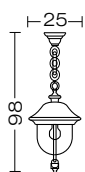

350.02L10  
.02L10H  
350A02L10  
A02L10H

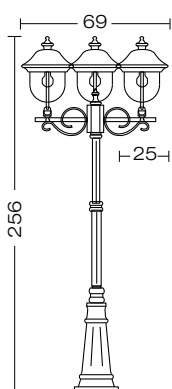

350.PF8T2L10  
.PF8T2L10H  
.PF8T3L10  
.PF8T3L10H

350APF8T2L10  
APF8T2L10H  
APF8T3L10  
APF8T3L10H

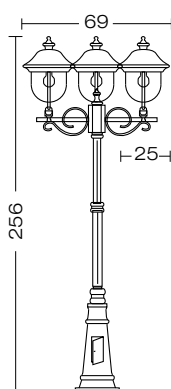

350.PE8T2L10  
.PE8T2L10H  
.PE8T3L10  
.PE8T3L10H

350APE8T2L10  
APE8T2L10H  
APE8T3L10  
APE8T3L10H

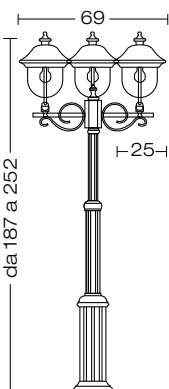

350.PR8T2L10  
.PR8T2L10H  
.PR8T3L10  
.PR8T3L10H

350APR8T2L10  
APR8T2L10H  
APR8T3L10  
APR8T3L10H

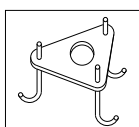

Anchor Bolt:  
code

350.PF4.....  
00APF6

350.PF7.....  
350.PF8.....  
350.PE7.....  
350.PE8.....  
00APF8

350.PR8.....  
00APR8

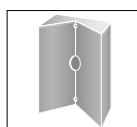

00108

angoliera  
corner bracket  
patte d'angle  
esquinera  
Eckhalterungen



esempio di fissaggio  
fixing example  
exemple de fixation  
ejemplo de fijación  
Beispiel von Fixierung





# romantica

art.  
**350**



example code:  
| art. | finishing | size | colour |  
350 . 33 ngv  
example copper top code:  
350 **A** 33 ngv

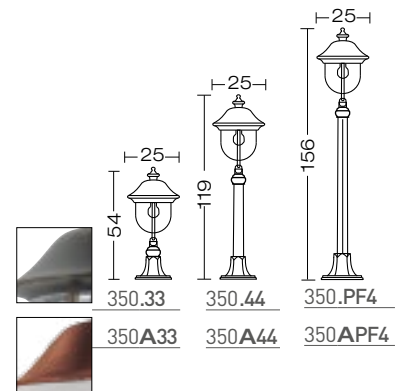
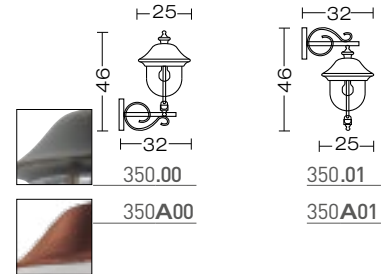

194 | TRADITIONAL

corpo alluminio pressofuso  
body in die casting aluminium  
corps en aluminium moulé  
sous pression  
cuerpo aluminio inyectado  
Körper aus Aluminium-  
Druckguss

diffusore policarbonato  
trasparente  
diffuser transparent  
polycarbonate  
diffuser polycarbonate  
transparent  
difusor policarbonato  
transparente  
Diffuser Polykarbonat klar

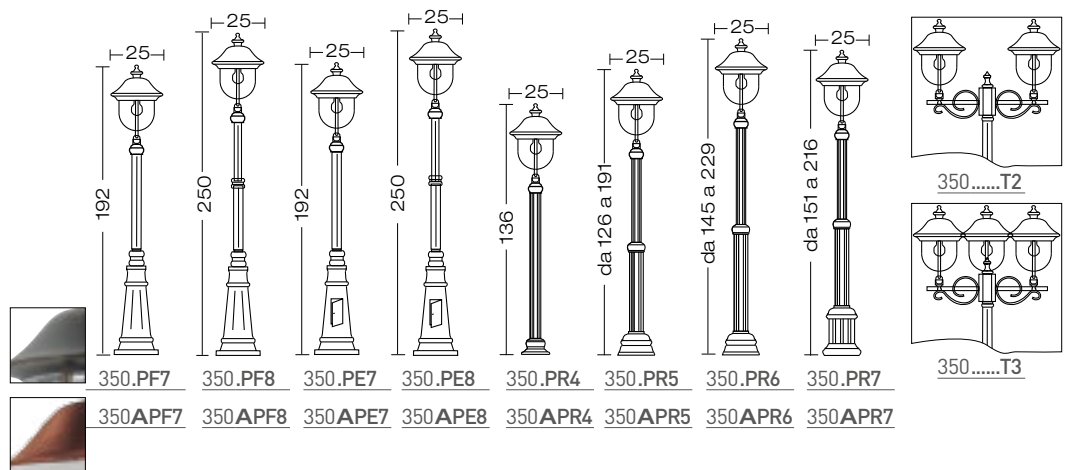

dettagli / details / details detalles / details:  
p.160-161

FOR TECHNICAL DETAILS VISIT  
[www.landa.it](http://www.landa.it)

IP43

960°



articoli disponibili anche con  
cappello in rame  
the items are also available  
with copper top  
ces articles sont disponibles aussi  
avec le chapeau en cuivre  
piezas disponibles  
también en cobre  
Diese Artikel sind auch mit  
Kupfer-Dach verfügbar

ELECTRIFICATION

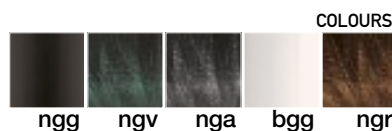
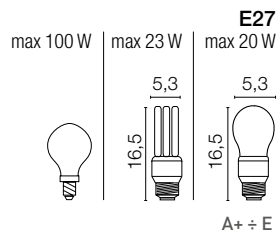

Accessories on request:

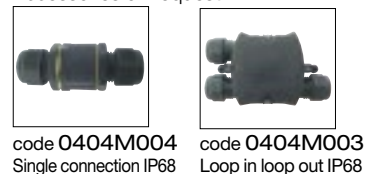

Energy efficiency classes

romantica

Projectors

Recessed

Contemporary

Traditional

TRADITIONAL



Thanks to Tesli - Russia

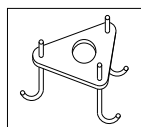
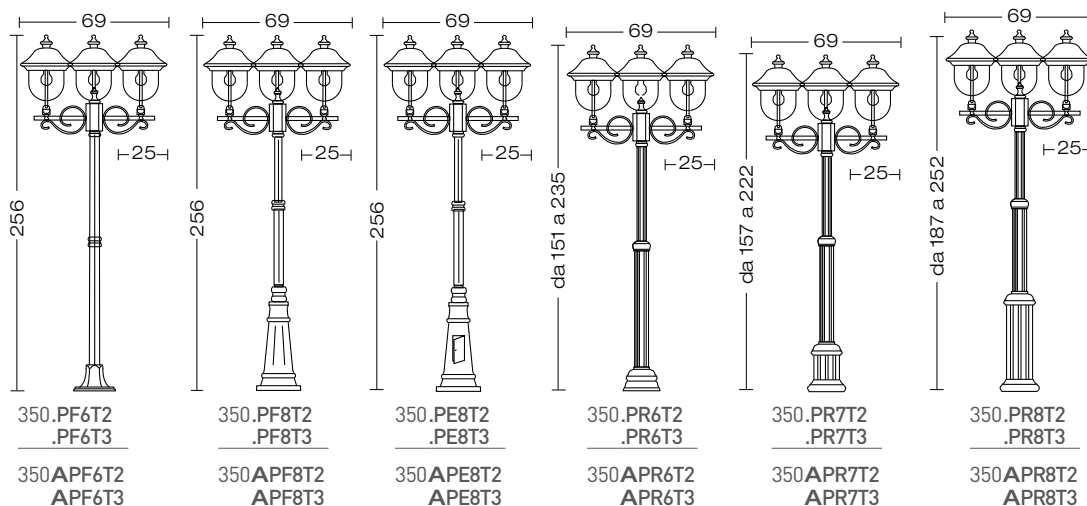
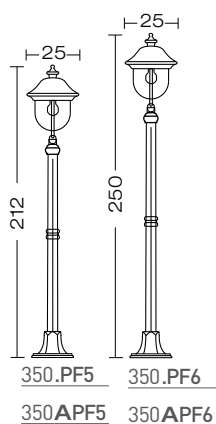
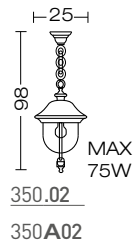

Anchor Bolt:  
code

350.PF4.....	350.PF7.....		
350.PF5.....	350.PF8.....		
350.PF6.....	350.PE7.....	350.PR5.....	350.PR7.....
	350.PE8.....	350.PR6.....	350.PR8.....
code <b>00APF6</b>	code <b>00APF8</b>	code <b>00APR6</b>	code <b>00APR8</b>

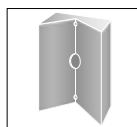

00108

angoliera  
corner bracket  
patte d'angle  
esquinera  
Eckhalterungen

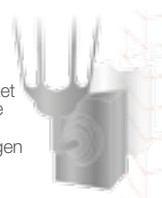

esempio di fissaggio  
fixing example  
exemple de fixation  
ejemplo de fijación  
Beispiel von Fixierung



# augusta

# LED

powered by  
Citizen Electronics® LED  
Transformer included

example code:

art. finishing size LED |  colour |  
360 . 01 L10 H ngg

example copper top code:

art. finishing size LED |  colour |  
360 **A** 01 L10 H ngg

art.  
**360**

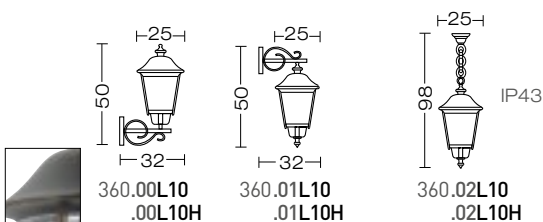

360.00L10  
.00L10H

360.01L10  
.01L10H

360.02L10  
.02L10H

360A00L10  
A00L10H

360A01L10  
A01L10H

360A02L10  
A02L10H

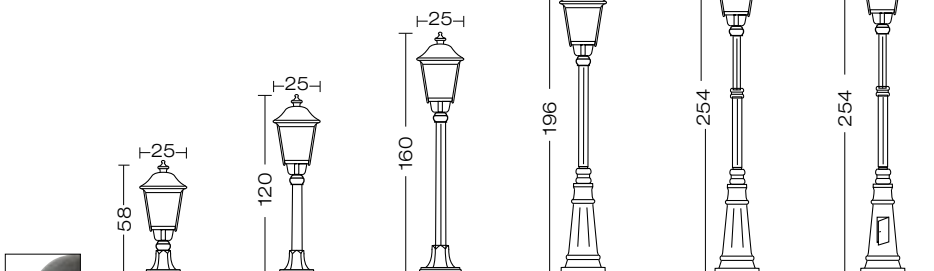

360.33L10  
.33L10H

360.44L10  
.44L10H

360.PF4L10  
.PF4L10H

360.PF7L10  
.PF7L10H

360.PF8L10  
.PF8L10H

360.PE8L10  
.PE8L10H

360A33L10  
A33L10H

360A44L10  
A44L10H

360APF4L10  
APF4L10H

360APF7L10  
APF7L10H

360APF8L10  
APF8L10H

360APE8L10  
APE8L10H

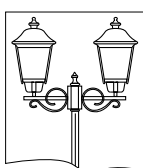

360.....T2

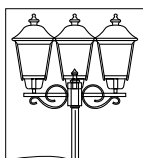

360.....T3

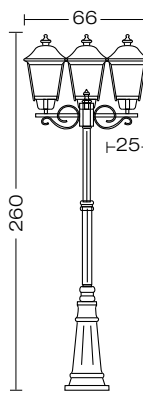

360.PF8T2L10  
.PF8T2L10H  
.PF8T3L10  
.PF8T3L10H

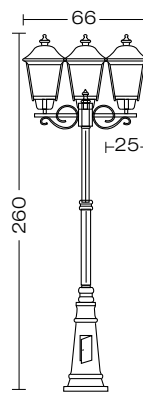

360.PE8T2L10  
.PE8T2L10H  
.PE8T3L10  
.PE8T3L10H

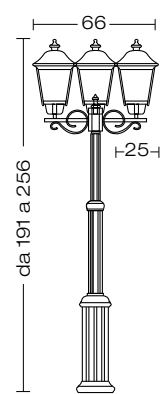

360.PR8T2L10  
.PR8T2L10H  
.PR8T3L10  
.PR8T3L10H



360APF8T2L10  
APF8T2L10H  
APF8T3L10  
APF8T3L10H

360APE8T2L10  
APE8T2L10H  
APE8T3L10  
APE8T3L10H

360APR8T2L10  
APR8T2L10H  
APR8T3L10  
APR8T3L10H

corpo alluminio pressofuso  
body in die casting aluminium  
corps en aluminium moulé  
sous pression  
cuerpo aluminio inyectado  
Körper aus Aluminium-  
Druckguss

diffusore policarbonato frosted  
diffuser frosted polycarbonate  
diffuser polycarbonate frosted  
difusor policarbonato frosted  
Diffuser Polykarbonat frosted

dettagli / details / details detalles / details:  
p.160-161

FOR TECHNICAL DETAILS VISIT  
[www.landa.it](http://www.landa.it)

IP44

960°

TOP  
FINISHING



code 360A.....



articoli disponibili anche con  
cappello in rame  
the items are also available  
with copper top  
ces articles sont disponibles aussi  
avec le chapeau en cuivre  
piezas disponibles  
también en cobre  
Diese Artikel sind auch mit  
Kupfer-Dach verfügbar

ELECTRIFICATION

# LED

dettagli / details / details  
detales / details:  
p.A54 - A55

Energy efficiency classes

**L10**  
LED 10 W  
5000K  
1300LM  
Ra80



**L10H**  
LED 10 W  
3000K  
1100LM  
Ra80



A++ ÷ A

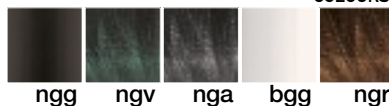

COLOURS

Accessories on request:



code 0404M004  
Single connection IP68



code 0404M003  
Loop in loop out IP68

augusta



Projectors

Recessed

Contemporary

Traditional

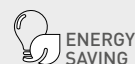

TRADITIONAL

197

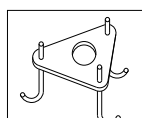

Anchor Bolt:  
code

360.PF4.....  
00APF6

360.PF7.....  
360.PF8.....  
360.PE7.....  
360.PE8.....  
00APF8

360.PR8.....  
00APR8

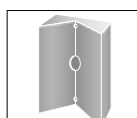

00108

angoliera  
corner bracket  
patte d'angle  
esquinera  
Eckhalterungen



esempio di fissaggio  
fixing example  
exemple de fixation  
ejemplo de fijación  
Beispiel von Fixierung



# augusta

art.  
**360**

example code:

art.	finishing	size	colour
360	.	02	nga

example copper top code:

art.	finishing	size	colour
360	<b>A</b>	02	nga

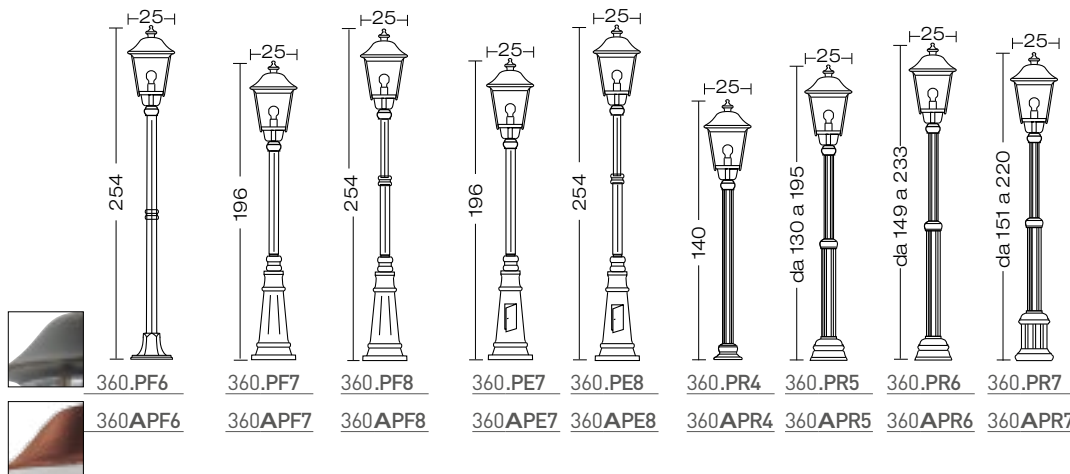
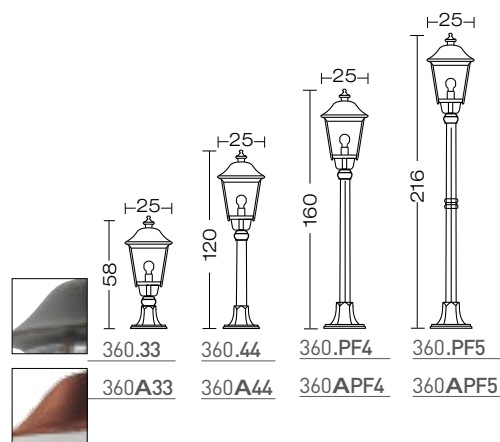
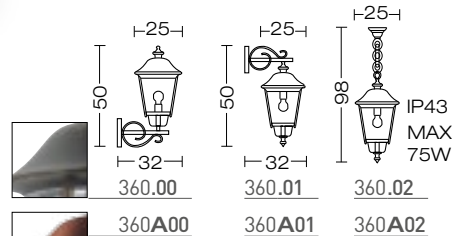

198 | TRADITIONAL

corpo alluminio pressofuso  
body in die casting aluminium  
corps en aluminium moulé  
sous pression  
cuerpo aluminio inyectado  
Körper aus Aluminium-  
Druckguss

diffusore policarbonato  
trasparente  
diffuser transparent  
polycarbonate  
diffuser polycarbonate  
transparent  
difusor policarbonato  
transparente  
Diffuser Polykarbonat klar

dettagli / details / details detalles / details:  
p.160-161

FOR TECHNICAL DETAILS VISIT  
[www.landa.it](http://www.landa.it)

IP44

960°

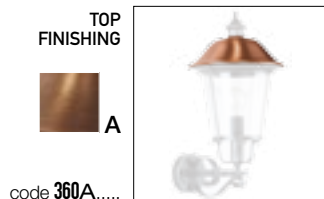

code 360A....

articoli disponibili anche con  
cappello in rame  
the items are also available  
with copper top  
ces articles sont disponibles aussi  
avec le chapeau en cuivre  
piezas disponibles  
también en cobre  
Diese Artikel sind auch mit  
Kupfer-Dach verfügbar

ELECTRIFICATION

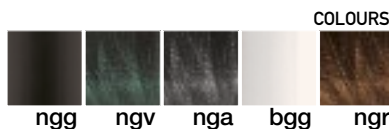
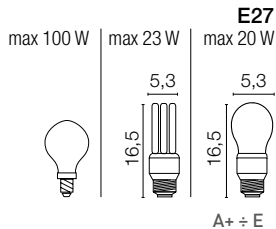

Accessories on request:



code 0404M004  
Single connection IP68



code 0404M003  
Loop in loop out IP68

Energy efficiency classes

augusta

Projectors

Recessed

Contemporary

Traditional



TRADITIONAL

199

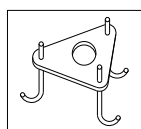
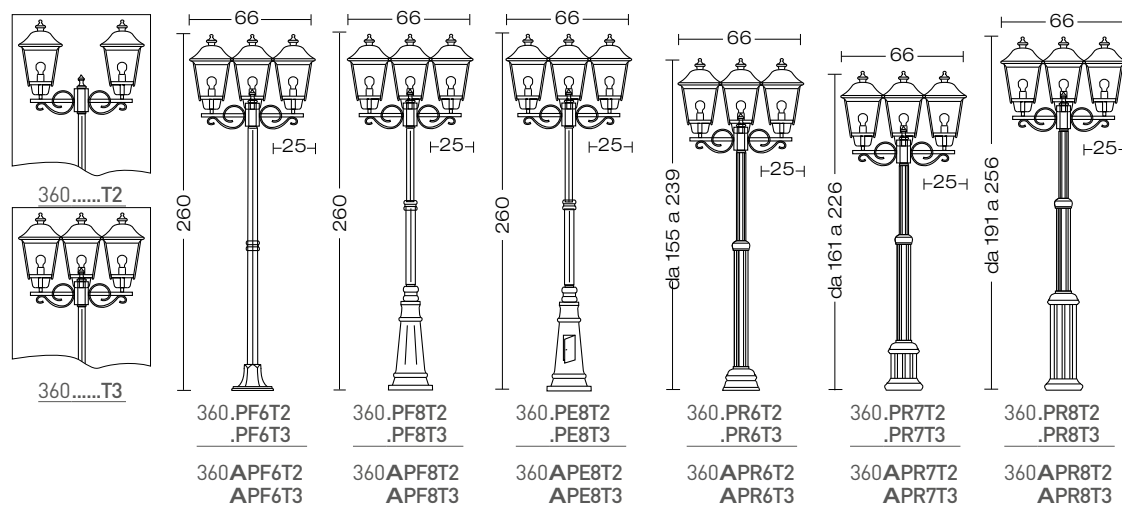

Anchor Bolt:  
code

360.PF4.....	360.PF7.....		
360.PF5.....	360.PF8.....		
360.PF6.....	360.PE7.....	360.PR5.....	360.PR7.....
	360.PE8.....	360.PR6.....	360.PR8.....
00APF6	00APF8	00APR6	00APR8

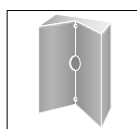

00108

angoliera  
corner bracket  
patte d'angle  
esquinera  
Eckhalterungen

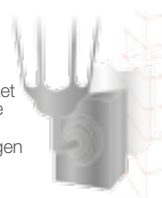

esempio di fissaggio  
fixing example  
exemple de fixation  
ejemplo de fijación  
Beispiel von Fixierung



# nizza

art.  
**390-391**

example code:  
| art. | finishing | size | colour |  
391 . 01 ngr

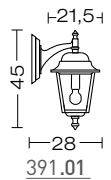
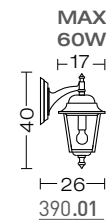
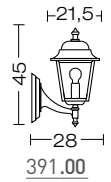
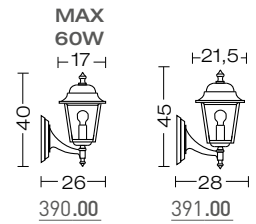

200 | TRADITIONAL

corpo alluminio pressofuso  
body in die casting aluminium  
corps en aluminium moulé  
sous pression  
cuerpo aluminio inyectado  
Körper aus Aluminium-  
Druckguss

diffusore vetro  
diffuser glass  
diffuser verre  
difusor vidrio  
Diffuser Glas

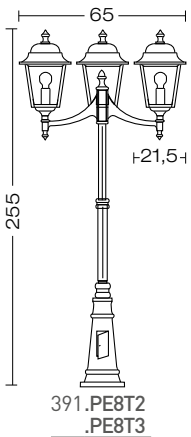
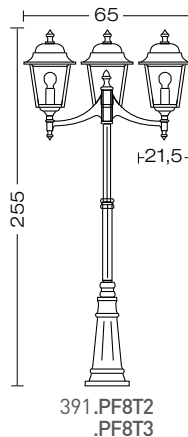
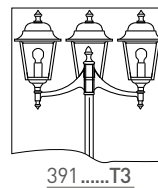
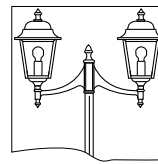
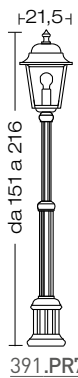
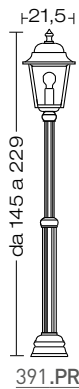
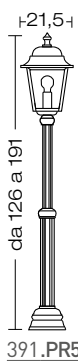
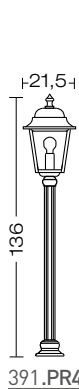
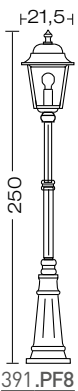
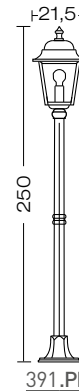
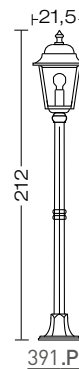
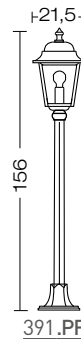
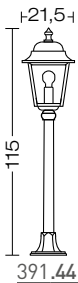
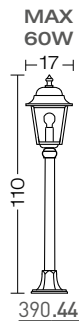

dettagli / details / details detalles / details:  
p.160-161

FOR TECHNICAL DETAILS VISIT  
[www.landa.it](http://www.landa.it)

IP43

ELECTRIFICATION

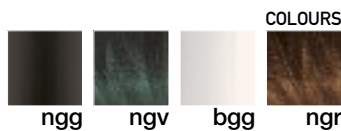
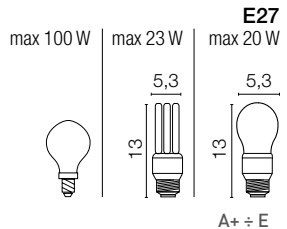

Accessories on request:



code 0404M004  
Single connection IP68



code 0404M003  
Loop in loop out IP68

Energy efficiency classes

nizza

Projectors

Recessed

Contemporary

Traditional

TRADITIONAL

201



Thanks to Ansell Lighting - UK

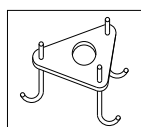
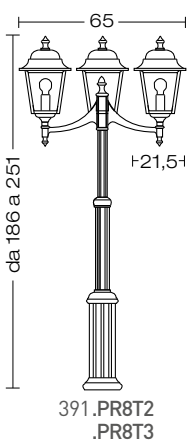
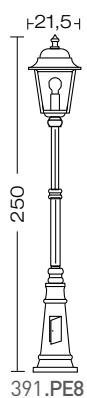
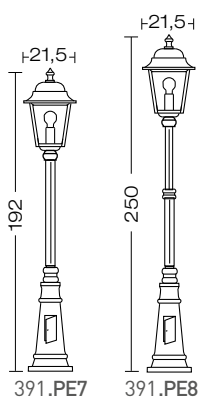
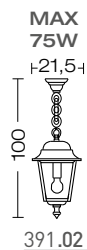
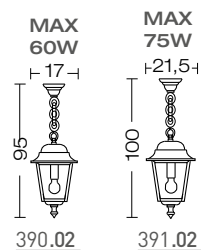

Anchor Bolt:  
code

391.PF4.....  
391.PF5.....  
391.PF6.....  
00APF6

391.PF7.....  
391.PF8.....  
391.PE7.....  
391.PE8.....  
00APF8

391.PR5.....  
391.PR6.....  
00APR6

391.PR7.....  
391.PR8.....  
00APR8

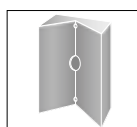

00108

angoliera  
corner bracket  
patte d'angle  
esquinera  
Eckhalterungen



esempio di fissaggio  
fixing example  
ejemplo de fijación  
Beispiel von Fixierung





# pisa

art.  
**300**

example code:  
| art. | finishing | size | colour |  
300 . 02 ngg

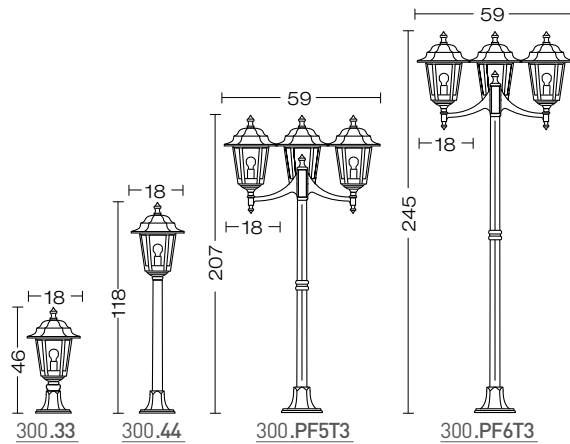
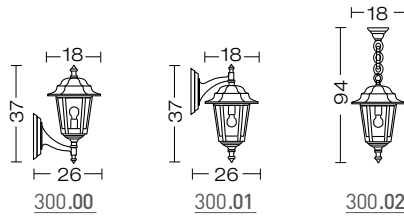

corpo alluminio pressofuso  
body in die casting aluminium  
corps en aluminium moulé  
sous pression  
cuerpo aluminio inyectado  
Körper aus Aluminium-  
Druckguss

diffusore vetro  
diffuser glass  
diffuser verre  
difusor vidrio  
Diffuser Glas

202 | TRADITIONAL

dettagli / details / details detalles / details:  
p.160-161

FOR TECHNICAL DETAILS VISIT  
[www.landa.it](http://www.landa.it)

IP43

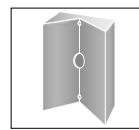
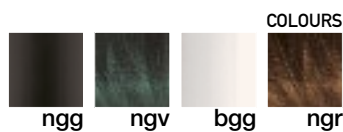

angoliera  
corner bracket  
patte d'angle  
esquinera  
Eckhalterungen

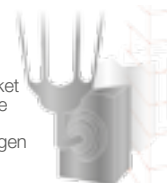

esempio di fissaggio  
fixing example  
exemple de fixation  
ejemplo de fijación  
Beispiel von Fixierung

ELECTRIFICATION



Energy efficiency classes

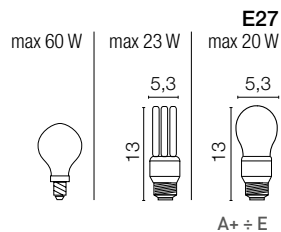

Accessories on request:



code 0404M004  
Single connection IP68



code 0404M003  
Loop in loop out IP68

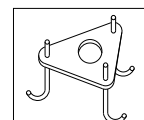

Anchor Bolt:  
code 00APF6

# oslo

art.  
**301**

Projectors

Recessed

Contemporary

Traditional



ENERGY SAVING

TRADITIONAL  
203

corpo alluminio pressofuso  
body in die casting aluminium  
corps en aluminium moulé  
sous pression  
cuerpo aluminio inyectado  
Körper aus Aluminium-  
Druckguss

diffusore vetro  
diffuser glass  
diffuser verre  
difusor vidrio  
Diffuser Glas

dettagli / details / details detalles / details:  
p.160-161

FOR TECHNICAL DETAILS VISIT  
[www.landa.it](http://www.landa.it)

IP43

ELECTRIFICATION



Energy efficiency classes

example code:

art.	finishing	size	colour
301	.	02	ngg

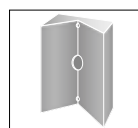
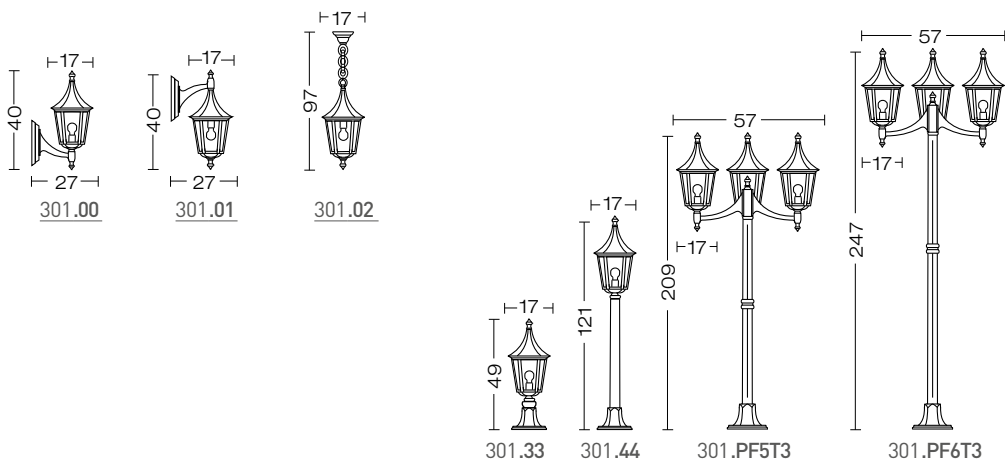

00108

angoliera  
corner bracket  
patte d'angle  
esquinera  
Eckhalterungen

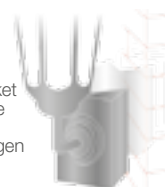

esempio di fissaggio  
fixing example  
exemple de fixation  
ejemplo de fijación  
Beispiel von Fixierung

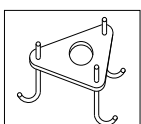

301.PF5....  
301.PF6....

Anchor Bolt:  
code **00APF6**

Accessories on request:



code **0404M004**  
Single connection IP68



code **0404M003**  
Loop in loop out IP68

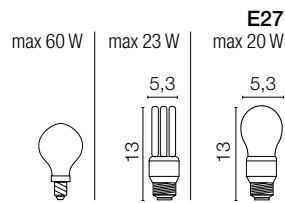

serie/series

rio

LED

powered by:  
Vossloh 13W  
AC direct connection  
220/240V  
Transformer not required

example code:  
art. LED | diffuser | colour |  
425 LV12 H B ngg  
example copper top code:  
art. finishing | electrification | colour |  
425 A PL13 ngg

art.  
425



204 | TRADITIONAL

corpo alluminio pressofuso  
body in die casting aluminium  
corps en aluminium moulé  
sous pression  
cuerpo aluminio inyectado  
Körper aus Aluminium-  
Druckguss

diffusore policarbonato  
diffuser polycarbonate  
diffuser polycarbonate  
difusor policarbonato  
Diffuser Polykarbonat



425LV12NB  
425LV12HB



425ALV12NB  
425ALV12HB

opale  
opal  
opale  
ópal  
opal  
85°

LED  
powered by  
Vossloh 13W  
AC direct connection  
220/240V  
Transformer not required

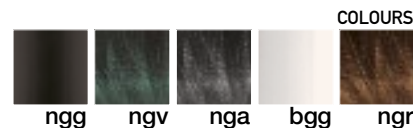
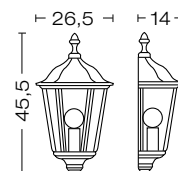

FOR TECHNICAL DETAILS VISIT  
[www.landa.it](http://www.landa.it)

IP44

TOP  
FINISHING



code 425A....



articoli disponibili anche con  
cappello in rame  
the items are also available  
with copper top  
ces articles sont disponibles aussi  
avec le chapeau en cuivre  
piezas disponibles  
también en cobre  
Diese Artikel sind auch mit  
Kupfer-Dach verfügbar

ELECTRIFICATION

LED

dettagli / details / details  
détalles / details:  
p.A54 - A55

Energy efficiency classes

LV12NB  
LED 1x13W  
4000K  
1160LM  
Ra80



A+++ ÷ A

LV12HB  
LED 1x13W  
3000K  
1140LM  
Ra80



A+++ ÷ A

Projectors

Recessed

Contemporary

Traditional

TRADITIONAL



425B (E27)  
425PL13



425SEN (E27)



425AB (E27)  
425APL13



425ASEN (E27)

opale  
opal  
opale  
ópaló  
opal  
850°



425 (E27)



425A



trasparente  
transparent  
transparent  
transparente  
klar  
850°  
□

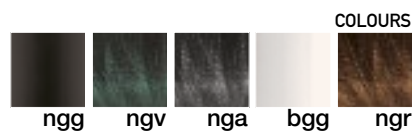
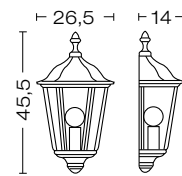

sensor



dettagli  
details  
detailes  
details:  
p.A56

1x max 100 W



1x max 23 W



1x max 20 W

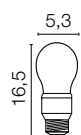

A+ ÷ E

E27  
PL13  
1x13 W  
G24 d-1



A+ ÷ B



# cipro

# LED

powered by:  
Vossloh 13W  
AC direct connection  
220/240V  
Transformer not required

example code:

art. | LED | ○ | diffuser | colour |  
420 | LV12 | H | B | ngr

art.  
**420**



206 | TRADITIONAL

corpo alluminio pressofuso  
body in die casting aluminium  
corps en aluminium moulé  
sous pression  
cuerpo aluminio inyectado  
Körper aus Aluminium-  
Druckguss

diffusore policarbonato  
diffuser polycarbonate  
diffuser polycarbonate  
difusor policarbonato  
Diffuser Polykarbonat



opale  
opal  
opale  
ópalo  
opal  
850°

420LV12NB  
420LV12HB

**LED**  
powered by  
Vossloh 13W  
AC direct connection  
220/240V  
Transformer not required

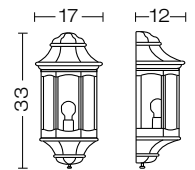

# LED

dettagli / details / details  
detalles / details:  
p.A54 - A55



opale  
opal  
opale  
ópalo  
opal  
850°

420B (E27)  
420PL13



trasparente  
transparent  
transparent  
transparente  
klar  
850°

420 (E27)

FOR TECHNICAL DETAILS VISIT  
[www.landa.it](http://www.landa.it)

IP44

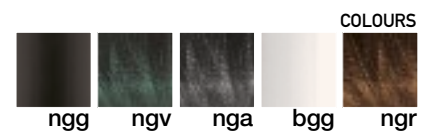

ELECTRIFICATION



Energy efficiency classes

**LV12NB**  
13W  
4000K  
1160LM  
Ra80



A++ ÷ A

**LV12HB**  
13W  
3000K  
1140LM  
Ra80



A++ ÷ A

1x max 100 W	1x max 23 W	1x max 20 W	<b>E27</b>	<b>PL13</b>
			5,3	1x13 W G24D1
	16,5	16,5	A+ ÷ E	A+ ÷ B

# maiorca

art.  
**421**

Projectors

Recessed

Contemporary

Traditional



TRADITIONAL

207

corpo alluminio pressofuso  
body in die casting aluminium  
corps en aluminium moulé  
sous pression  
cuerpo aluminio inyectado  
Körper aus Aluminium-  
Druckguss

diffusore policarbonato  
diffuser polycarbonate  
diffuser polycarbonate  
difusor policarbonato  
Diffuser Polykarbonat

## LED

dettagli / details / details  
detalles / details:  
p.A54 - A55

FOR TECHNICAL DETAILS VISIT  
[www.landa.it](http://www.landa.it)

IP44

example code:  
art. | electrification | colour  
421 | PL13 | ngv



Thanks to KSR Lighting - UK



opale  
opal  
opale  
ópaló  
opal

850°

**LED**  
powered by  
Vossloh 13W  
AC direct connection  
220/240V  
Transformer not required

421LV12NB  
421LV12HB



opale  
opal  
opale  
ópaló  
opal

850°

421B (E27)  
421PL13



trasparente  
transparent  
transparent  
transparente  
klar

850°

421 (E27)

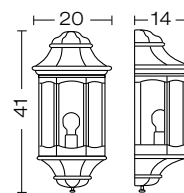

421BSEN (E27)

COLOURS

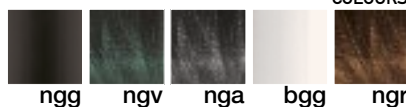

## sensor



dettagli  
details  
details  
detalles:  
p.A56

1x max 100 W



1x max 23 W

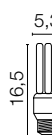

1x max 20 W

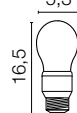

A+ ÷ E

E27  
PL13  
1x13 W  
G24D1



A+ ÷ B

LV12NB  
13W  
4000K  
1160LM  
Ra80



A++ ÷ A

LV12HB  
13W  
3000K  
1140LM  
Ra80



A++ ÷ A

ELECTRIFICATION



Energy efficiency classes

I prodotti del Gruppo Landa, sono conformi alle norme europee

The products of Landa Group are conformed to European standards.

Les produits du groupe Landa sont conformes aux normes européennes

Los productos del la Landa Group están fabricados según las normativas de la Comunidad Europea

Die Produkte der Gruppe Landa entsprechen den europäischen Vorschriften



Indica che il prodotto è certificato secondo le norme europee.  
*Indicates that the product conforms to European standards.*  
*Indique que le produit est certifié conformément aux normes européennes.*  
*Los productos están fabricados según las normativas de la Comunidad Europea.*  
*Bedeutet, dass das Produkt entsprechend den europäischen Vorschriften zertifiziert ist.*

IP..

"IP" indica la classificazione secondo il grado di protezione contro la penetrazione di polvere, corpi solidi ed umidità.  
*"IP" indicates the degree of protection against penetration of dust, solid bodies and humidity.*  
*"IP" indique la classification selon le degré de protection contre la pénétration de la poussière, des corps solides et de l'humidité.*  
*"IP": protección contra la penetración de objetos sólidos y protegido contra los líquidos.*  
*"IP" entspricht der Klassifizierung des Schutzgrads in Bezug auf das Eindringen von Staub, festen Körpern und Feuchtigkeit.*

IP20

Protetto contro la penetrazione dei corpi solidi Ø >12 mm e non contro i liquidi.  
*Protected against penetration of solid bodies Ø >12 mm but not against liquids.*  
*Protégé contre la pénétration des corps solides Ø >12 mm et non contre les liquides.*  
*Protección contra la penetración de objetos sólidos menor que 12 mm. y no protegido contra los líquidos*  
*Gegen Eindringen von festen Körpern Ø >12 mm bzw. nicht gegen Flüssigkeiten geschützt.*

IP23

Protetto contro la penetrazione dei corpi solidi Ø >12 mm e contro la pioggia.  
*Protected against penetration of solid bodies Ø >12 mm and protected against rain.*  
*Protégé contre la pénétration des corps solides Ø >12 mm et protégé de la pluie.*  
*Protección contra la penetración de objetos sólidos menor que 12 mm. y contra el agua en forma de lluvia hasta 60° de inclinación.*  
*Gegen Eindringen von festen Körpern Ø >12 mm sowie gegen Regen geschützt.*

IP43

Protetto contro la penetrazione dei corpi solidi Ø >1 mm e contro la pioggia.  
*Protected against penetration of solid bodies Ø > 1 mm and protected against rain.*  
*Protégé contre la pénétration des corps solides Ø >1 mm et protégé de la pluie.*  
*Protección contra la penetración de cuerpos sólidos menor que 1 mm. y contra el agua en forma de lluvia hasta 60° de inclinación.*  
*Gegen Eindringen von festen Körpern Ø >1 mm sowie gegen Regen geschützt.*

IP44

Protetto contro la penetrazione dei corpi solidi Ø >1 mm e contro gli spruzzi d'acqua.  
*Protected against penetration of solid bodies Ø > 1 mm and protected against water sprays.*  
*Protégé contre la pénétration des corps solides Ø >1 mm et contre les éclaboussures d'eau.*  
*Protección contra la penetración de cuerpos sólidos menor que 1 mm. y contra proyecciones de agua en todas direcciones.*  
*Gegen Eindringen von festen Körpern Ø >1 mm sowie gegen Spritzwasser geschützt.*

IP54

Protetto contro la penetrazione della polvere e contro gli spruzzi d'acqua.  
*Protected against penetration of dust and against water sprays.*  
*Protégé contre la pénétration de la poussière et contre les éclaboussures d'eau.*  
*Protección contra la penetración de polvo y contra proyecciones de agua en todas direcciones.*  
*Gegen Eindringen von Staub sowie gegen Spritzwasser geschützt.*

IP55

Protetto contro la penetrazione della polvere e protetto contro i getti d'acqua.  
*Protected against penetration of dust and water tight.*  
*Protégé contre la pénétration de la poussière et protégé contre les jets d'eau.*  
*Protección contra la penetración de polvo y contra chorros de agua en todas direcciones.*  
*Gegen Eindringen von Staub sowie gegen Wasserstrahlen geschützt.*

IP65

Stagno alla penetrazione della polvere e protetto contro i getti d'acqua.  
*Dust tight and protected against water jets.*  
*Étanche a la poussière et protégé contre les jets d'eau.*  
*Totalmente protegida contra la penetración de polvo y contra chorros de agua en todas direcciones.*  
*Staubdicht und geschützt vor Wasserstrahlen.*

IP67

Stagno alla penetrazione della polvere e protetto contro gli effetti delle ondate.  
*Dust and waterwave tight.*  
*Étanche a la poussière et protégé contre les jets d'eau.*  
*Totalmente protegida contra la penetración de polvo y contra los efectos de la inmersión temporal.*  
*Staubdicht und geschützt vor Wellen.*

La ditta si riserva di apportare, senza obbligo di preavviso, tutte le modifiche migliorative riportate agli articoli su questo catalogo.

*The company reserves the right to make improvements to the products described in this catalogue without giving prior notice.*

*L'entreprise se réserve la faculté d'effectuer sans préavis toutes les modifications qu'elle jugera utiles pour améliorer les articles présentes dans ce catalogue.*

*La firma se reserva, sin previo aviso, de aportar todas las modificaciones que sean necesarias para mejorar sus productos, relatados en este catálogo.*

*Unsere Firma behält sich vor, Sämtliche Änderungen an den in diesem Katalog enthaltenen Artikeln ohne vorherige Benachrichtigung vorzunehmen, welche aufgrund der technologischen Entwicklung erforderlich sein könnten.*





# LANDA<sup>®</sup>

## Terms & Conditions

### General

- Buyer means the person, firm or company who purchases Goods from the company
- Company means Landa Illuminotecnica S.p.A.. via Rosmini 13/15, 25065 Lumezzane (BS), Italy
- Contract means the Contract between the Buyer and the Company for the sale and purchase of Goods
- Goods means the Goods which the Company is to supply in accordance with these conditions

### Basic of Sale

- The Company shall sell and the Buyer shall purchase the Goods in accordance with these conditions, which shall govern the Contract to the exclusion of any other terms and conditions which the Buyer purports to apply under any purchase order, confirmation order, specification or other document
- No variation to these conditions shall be binding unless agreed in writing by the Company
- Any typographical, clerical or other error or omission in any sales literature, quotation, price list, acceptance of offer, invoice or other document or information issued by the Company shall be subject to correction without liability on the part of the Company.
- Goods supplied may vary in detail from illustrations, drawings, measurements and descriptions set out in the Company sales literature, which are approximate and for guidance only and will not form part of the Contract. Colour finishes will be maintained as accurately as possible but matching cannot be guaranteed. All terminology used in the Company's sales literature is subject to these conditions.

### Orders

- No order submitted by the Buyer shall be deemed to be accepted by the Company unless and until confirmed in writing by the Company
- The Buyer shall be responsible to the Company for ensuring the accuracy of the terms of any order submitted by the Buyer, and for giving the Company any necessary information relating to the Goods within a sufficient time to enable the Company to perform the Contract in accordance with its terms.
- No Goods may be returned to the Company without the Company's prior written consent and must be returned in their original packaging to ensure no damage is sustained during transit. The Buyer shall be liable for the cost of returning the Goods and for any damage to the Goods prior to receipt by the Company of such returned Goods.

### Price of Goods

- The price of the Goods shall be the price listed in the Company's published price list in EURO currency.
- Unless otherwise agreed in writing between the Buyer and the Company, all prices are given by the Company on an ex-works basis, and where the Company agrees to deliver the Goods otherwise than at the Company's premises. The Buyer shall be liable to pay the Company's charges for transport.

### Warranties

- Outdoor lighting fixtures are guaranteed against defects in material or workmanship for a period of two years following the date of delivery ex-works.
- No warranty is granted in connection with faults resulting from improper use, application, normal wear and tear, external influences or use of non-original replacement parts, damage resulting from transportation.
- The Company recommends that the installation of outdoor lighting fixtures is made by a skilful person and that the enclosed assembly instructions are followed and kept for further future maintenance.
- The Company will not assume responsibility for corrosion or other resulting damage to the Goods where they are installed in areas in which fertilizer or salt are present, either in the air or in the soil or where Goods are installed near to chemical plants etc with emissions of heavily polluted air. The Buyer undertakes to inform his customers about the regular maintenance of the products. In particular for the products in stainless steel AISI 316, by means of the technical sheets included in his catalogue, the distributor will inform his customer regarding the specific products (among which also those available from the Company aimed to remove possible colour spots) liable to keep the features of the products unaltered. Claims should be promptly submitted in a written form to the Company together with copy of the purchase invoice and stating the delivery date, description of the faults and quantity of faulty products. Products that are proved to be defective in material or workmanship will be repaired, replaced by the Company within a reasonable period after the claim. Returns of faulty Goods will be accepted by the Company only upon written authorization, adequately despatched and packed with transport prepaid. Extra costs borne by the Buyer in consequence of the faults of the products will not be carried by the Company, if not previously agreed in written form.
- The Company will not assume any responsibility in the following cases: improper assembly, use or maintenance of the products and their incorrect conservation. This guarantee shall not apply to products that have been altered, improperly used or installed or repaired without prior written authorization from the Company. If quality and performance have become less due to the application of accessories not approved by the Company. This guarantee deletes and replaces any other further responsibility arising from the products supplied; in particular the Buyer shall have no right to claim for damages reimbursement (indirect or consequent damages included or profit losses) reduction of prices or resolution of the Contract.

### LANDA ILLUMINOTECNICA S.p.A.

Via Rosmini, 13/15 - 25065 Lumezzane S.A. - Brescia - Italy - Tel. +39 030 89 20 966 - Fax +39 030 89 21 003 - [www.landa.it](http://www.landa.it) - e-mail: [info@landa.it](mailto:info@landa.it)  
Copyright© 2016

LANDA

illuminotecnica

LANDA illuminotecnica S.p.A. - Via Rosmini, 13/15 - 25065 Lumezzane S.A. Brescia - Italy - Tel. +39 030 89 20 966 - Fax +39 030 89 21 003 - info@landa.it

[www.landa.it](http://www.landa.it)

